

Robert Bosch Power Tools GmbH
70538 Stuttgart
GERMANY

www.bosch-pt.com

1 609 92A 3F6 (2015.12) AS / 12



1 609 92A 3F6

GSB 120-LI Professional



cn 正本使用说明书



2 | 中文

中文

电动工具通用安全警告

警告！ 阅读所有警告和所有说明！不遵照以下警告和说明会导致电击、着火和/或严重伤害。

保存所有警告和说明书以备查阅。

在所有下列的警告中术语“电动工具”指市电驱动（有线）电动工具或电池驱动（无线）电动工具。

工作场地的安全

- ▶ 保持工作场地清洁和明亮。混乱和黑暗的场地会引发事故。
- ▶ 不要在易爆环境，如有易燃液体、气体或粉尘的环境下操作电动工具。电动工具产生的火花会点燃粉尘或气体。
- ▶ 让儿童和旁观者离开后操作电动工具。注意力不集中会使操作者失去对工具的控制。

电气安全

- ▶ 电动工具插头必须与插座相配。绝不能以任何方式改装插头。需接地的电动工具不能使用任何转换插头。未经改装的插头和相配的插座将减少电击危险。
- ▶ 避免人体接触接地表面，如管道、散热片和冰箱。如果你身体接地会增加电击危险。
- ▶ 不得将电动工具暴露在雨中或潮湿环境中。水进入电动工具将增加电击危险。
- ▶ 不得滥用电线。绝不能用电线搬运、拉动电动工具或拔出其插头。使电线远离热源、油、锐边或运动部件。受损或缠绕的软线会增加电击危险。
- ▶ 当在户外使用电动工具时，使用适合户外使用的外接软线。适合户外使用的软线将减少电击危险。
- ▶ 如果在潮湿环境下操作电动工具是不可避免的，应使用剩余电流动作保护器（RCD）。使用 RCD 可减少电击危险。

人身安全

- ▶ 保持警觉，当操作电动工具时关注所从事的操作并保持清醒。当你感到疲倦，或在有药物、酒精或治疗反应时，不要操作电动工具。在操作电动工具时瞬间的疏忽会导致严重人身伤害。
- ▶ 使用个人防护装置。始终佩戴护目镜。安全装置，诸如适当条件下使用防尘面具、防滑安全鞋、安全帽、听力防护等装置能减少人身伤害。
- ▶ 防止意外启动。确保开关在连接电源和/或电池盒、拿起或搬运工具时处于关断位置。手指放在已接通电源的开关上或开关处于接通时插入插头可能会导致危险。

- ▶ 在电动工具接通之前，拿掉所有调节钥匙或扳手。遗留在电动工具旋转零件上的扳手或钥匙会导致人身伤害。
- ▶ 手不要伸展得太长。时刻注意立足点和身体平衡。这样在意外情况下能很好地控制电动工具。
- ▶ 着装适当。不要穿宽松衣服或佩戴饰品。让衣服、手套和头发远离运动部件。宽松衣服、佩饰或长发可能会卷入运动部件中。
- ▶ 如果提供了与排屑、集尘设备连接用的装置，要确保他们连接完好且使用得当。使用这些装置可减少尘屑引起的危险。

电动工具使用和注意事项

- ▶ 不要滥用电动工具，根据用途使用适当的电动工具。选用适当设计的电动工具会使你工作更有效、更安全。
- ▶ 如果开关不能接通或关断工具电源，则不能使用该电动工具。不能用开关来控制的电动工具是危险的且必须进行修理。
- ▶ 在进行任何调节、更换附件或贮存电动工具之前，必须从电源上拔掉插头和/或使电池盒与工具脱离。这种防护性措施将减少工具意外启动的危险。
- ▶ 将闲置不用的电动工具贮存在儿童所及范围之外，并且不要让不熟悉电动工具或对这些说明不了解的人操作电动工具。电动工具在未经培训的用户手中是危险的。
- ▶ 保养电动工具。检查运动件是否调整到位或卡住，检查零件破损情况和影响电动工具运行的其他状况。如有损坏，电动工具应在使用前修理好。许多事故由维护不良的电动工具引发。
- ▶ 保持切削刀具锋利和清洁。保养良好的有锋利切削刃的刀具不易卡住而且容易控制。
- ▶ 按照使用说明书，考虑作业条件和进行的作业来使用电动工具、附件和工具的刀头等。将电动工具用于那些与其用途不符的操作可能会导致危险。

电池式工具使用和注意事项

- ▶ 只用制造商规定的充电器充电。将适用于某种电池盒的充电器用到其他电池盒时会发生着火危险。
- ▶ 只有在配有专用电池盒的情况下才使用电动工具。使用其他电池盒会发生损坏和着火危险。
- ▶ 当电池盒不用时，将它远离其他金属物体，例如回形针、硬币、钥匙、钉子、螺钉或其他小金属物体，以防一端与另一端连接。电池端部短路会引起燃烧或火灾。
- ▶ 在滥用条件下，液体会从电池中溅出；避免接触。如果意外碰到了，用水冲洗。如果液体碰到了眼睛，还要寻求医疗帮助。从电池中溅出的液体会发生腐蚀或燃烧。

维修

- ▶ 将你的电动工具送交专业维修人员，使用同样的备件进行修理。这样将确保所维修的电动工具的安全性。

针对电钻和电动扳手的安全规章

- ▶ 使用冲击电钻时要戴好耳罩。暴露在噪声中会引起听力损伤。
- ▶ 使用随工具提供的辅助手柄。操作失手会引起人身伤害。
- ▶ 安装在机器上的工具或螺丝如果可能切断隐藏的电线，一定要按住绝缘手柄操作电动工具。电动工具如果切断了带电的电线，机器上的金属部件会导电，并进而导致操作者触电。
- ▶ 使用合适的侦测器，以便找出隐藏着的电源线的位置。或者向当地的供电单位索取相关资料。钻穿电线会造成火灾并遭受电击。损坏瓦斯管会引起爆炸。如果水管被刺穿了会导致财物损失。
- ▶ 如果安装在机器上的工具被夹住了，必须马上关闭电动工具并保持镇静。此时机器会产生极高的反应力矩，并进而造成回击。安装在机器上的工具容易被夹住如果：
 - 电动工具超荷了，或者
 - 安装在机器上的工具在工件中歪斜了。
- ▶ 务必握紧电动工具。在拧紧和放松螺丝时，可能出现短暂的强大反击。
- ▶ 固定好工件。使用固定装置或老虎钳固定工件，会比用手持握工件更牢固。
- ▶ 等待电动工具完全静止后才能够放下机器。机器上的工具可能在工作中被夹住，而令您无法控制电动工具。
- ▶ 切勿打开蓄电池。可能造成短路。
- ▶ 保护蓄电池免受高温（例如长期日照），火焰，水和湿气的侵害。有爆炸的危险。
- ▶ 如果蓄电池损坏了，或者未按照规定使用蓄电池，蓄电池中会散发出有毒蒸汽。工作场所必须保持空气流通，如果身体有任何不适必须马上就医。蓄电池散发的蒸汽会刺激呼吸道。
- ▶ 本蓄电池只能配合博世的电动工具一起使用。这样才能确保蓄电池不会过载。
- ▶ 通过尖的物件如钉子或螺丝刀通过外力作用时，可能损坏蓄电池。有可能出现内部短路、蓄电池燃烧、发出烟雾、爆炸或过热。

进一步的安全规章和工作指示

- ▶ 含铅的颜料以及某些木材、矿物和金属的加工废尘有害健康、可能造成过敏、让操作者感染呼吸道疾病

和 / 或罹患癌症。只有经过专业训练的人员才能够加工含石棉的物料。

- 工作场所要保持空气流通。
- 最好佩戴 P2 滤网等级的口罩。

请留心并遵守贵国和加工物料有关的法规。

- ▶ 避免让工作场所堆积过多的尘垢。尘埃容易被点燃。
- ▶ 交货时蓄电池只完成部分充电，为了确保能够发挥电池的最大功率，首度使用前必须把蓄电池放入充电器中充足电。
- ▶ 阅读充电器的使用说明书。
- ▶ 确定电动工具已经关闭了，才可以把电动工具顶在螺丝头上。转动中的起子头容易从螺丝头上滑开。
- ▶ 待电动工具完全静止后才能够启动选档开关。
- ▶ 如果无法把选档开关推到尽头，可以稍微转动夹头。

代表符号

以下的符号可以帮助您正确地使用本机器。请仔细阅读各符号及它们的代表意思。正确了解各符号所代表的意义，可以帮助您更有把握更安全地操作本机器。

| 符号 | 含义 |
|--|--|
|  | GSB 120-LI: 充电式冲击电钻起子机 打上灰色记号的部位：手柄（绝缘的握持位置） |
|  | 物品代码 X XXX XXX XXX |
|  | 阅读所有的安全规章和说明 |
|  | 在电动工具上进行任何维修的工作之前，都必须先取出蓄电池 |
|  | 请佩戴耳罩 |
|  | 移动方向 |
|  | 反应方向 |
|  | 正 / 逆转功能 |

4 | 中文

| 符号 | 含义 |
|--|--|
|  | 螺丝 |
|  | 正常钻无震动功能 |
|  | 冲击钻 |
|  | 低转速 |
|  | 高转速 |
|  | 开动 |
|  | 关闭 |
| U | 额定电压 |
| n_0 1 | 空转转速 (1 档) |
| n_0 2 | 空转转速 (2 档) |
| n_s | 冲击次数 |
| M | 根据 ISO 5393 的最大扭力 |
|  | 泥墙 |
|  | 金属 |
|  | 木材 |
| 直径 | 最大钻孔直径 |
| 直径  | 最大螺丝直径 |
|  | 夹头的夹紧范围 |
|  | 重量符合 EPTA-Procedure 01:2014 |
| * | 数值取决于所使用的电池组 |
| T_1 | 充电时允许的环境温度 |
| T_2 | 运行*和储藏时允许的环境温度 * 温度 $< 0^{\circ}\text{C}$ 时功率受限 |
|  | 建议使用的充电电池 |
|  | 推荐的充电器 |

供货范围

充电式冲击电钻起子机。
蓄电池，安装工具和其它在图表或说明上提到的附件，并不包含在基本的供货范围中。
在本公司的附件清单中标列了完整的附件。

按照规定使用机器

本电动工具适用于拧入和拧出螺丝。本电动工具也可以在木材、金属、陶瓷和塑料上钻孔，或者在砖块、混凝土与石材上进行冲击钻。

本电动工具的照明灯用于电动工具工作范围周围的照明，不适用于家庭房间照明。

技术数据

本产品的技术数据列在本使用说明书 6 页的表格中。请认清电动工具铭牌上的物品代码。电动工具在销售市场上没有统一的商品名称。

安装和操作

| 执行目的 | 图片 | 页数 |
|---------|----|----|
| 取出蓄电池 | 1 | 7 |
| 安装蓄电池 | 2 | 7 |
| 安装工具 | 3 | 7 |
| 改变转向 | 4 | 8 |
| 设定扭力 | 5 | 8 |
| 设定操作模式 | 6 | 9 |
| 机械式选档 | 7 | 9 |
| 开动 / 关闭 | 8 | 10 |
| 选择附件 | - | 11 |

维修和清洁

▶ 电动工具和通风间隙都必须保持清洁，这样才能提高工作品质和安全性。

顾客服务处和顾客咨询中心

本公司顾客服务处负责回答有关本公司产品的修理、维护和备件的问题。以下的网页中有爆炸图和备件的资料：
www.bosch-pt.com
博世顾客咨询团队非常乐意为您解答有关本公司产品及附件的问题。

如需查询和订购备件，请务必提供产品型号铭牌上的 10 位数货号。

有关保证，维修或更换零件事宜，请向合格的经销商查询。

中国大陆

博世电动工具（中国）有限公司
中国 浙江省 杭州市
滨江区滨康路 567 号
邮政编码：310052
免费服务热线：4008268484
传真：(0571) 87774502
电邮：contact.ptcn@cn.bosch.com
www.bosch-pt.com.cn

羅伯特·博世有限公司
香港北角英皇道 625 號 21 樓
客戶服務熱線: +852 2101 0235
傳真: +852 2590 9762
電郵: info@hk.bosch.com
網站: www.bosch-pt.com.hk

制造商地址:

Robert Bosch Power Tools GmbH
羅伯特·博世電動工具有限公司
70538 Stuttgart / GERMANY
70538 斯圖加特 / 德國

搬运

随着机器一起供货的锂离子蓄电池必须受危险物品法规范。使用者无须另外使用保护包装便可以运送该蓄电池。

但是如果将它交由第三者运送（例如：寄空运或委托运输公司）则要用特殊的包装和标示。此时必须向危险物品专家请教有关寄送危险物品的相关事宜。

确定蓄电池的外壳未受损后，才可以寄送蓄电池。粘好未加盖的触点并包装好蓄电池，不可以让蓄电池在包装中晃动。

必要时也得注意各国有关的法规。

处理废弃物











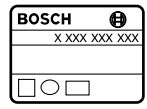

必须以符合环保的方式，回收再利用损坏的电动工具，蓄电池，附件和废弃的包装材料。

不可以把电动工具和蓄电池 / 电池丢入一般的家庭垃圾中！

保留修改权。

6 |

GSB 120-LI

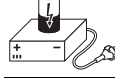
| | | |
|---|--------------------|----------------------------------|
|  | | 3 601 JF3 0.. |
| U | V= | 12 |
| $n_0 1$ | min^{-1} | 0 - 400 |
| $n_0 2$ | min^{-1} | 0 - 1300 |
| n_s | min^{-1} | 0 - 19500 |
| M  | Nm | 28 |
| M  | Nm | 11* |
| \emptyset  | mm | 8 |
| \emptyset  | mm | 6 |
| \emptyset  | mm | 19 |
| \emptyset  | mm | 7 |
|  | mm | 0.8 - 10 |
|  | kg | 1.1 |
| T_1 | $^{\circ}\text{C}$ | 0...+45 |
| T_2 | $^{\circ}\text{C}$ | -15...+50 |
|  | | GBA 10,8V...O- GBA 10,8V...M- |
|  | | GAL 12...CV |

1

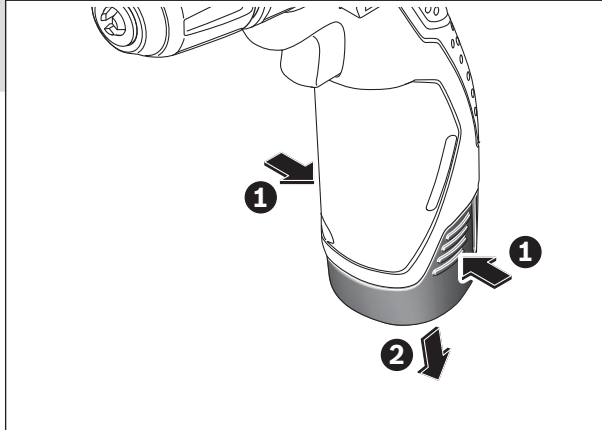
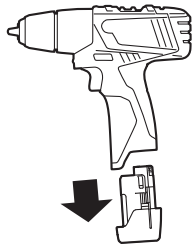

2

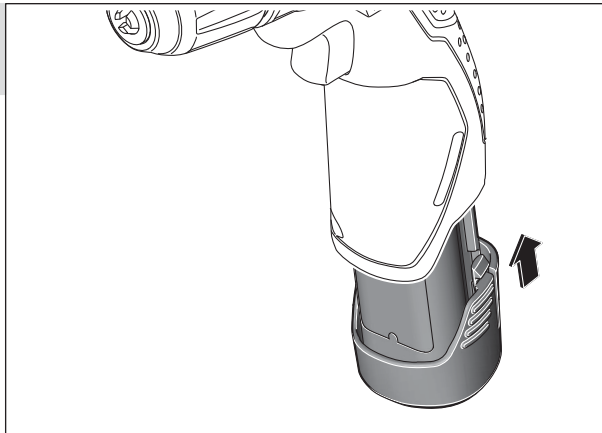
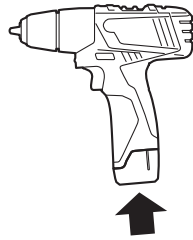

3

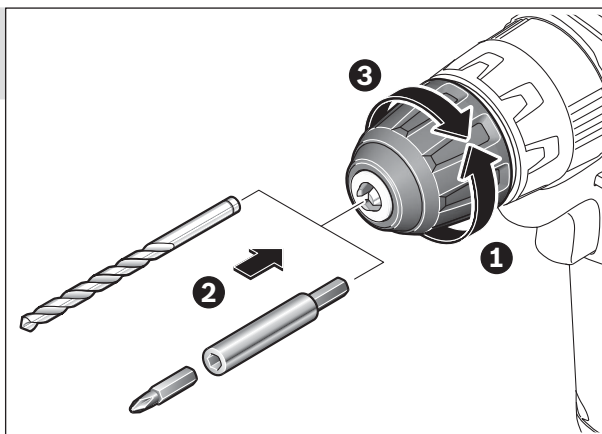
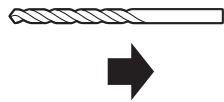

8 |

4

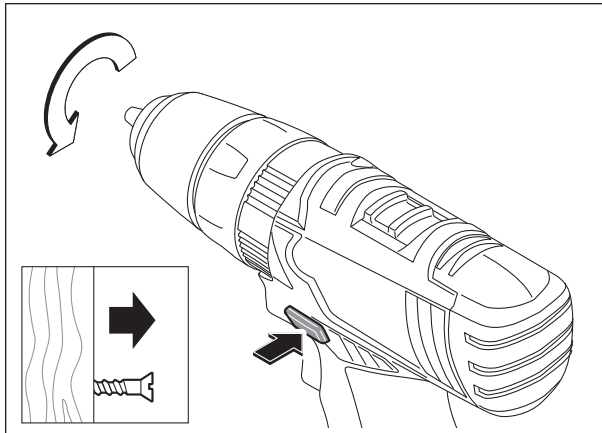
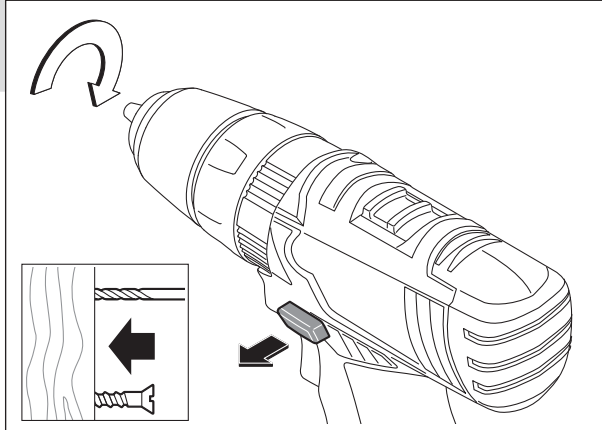
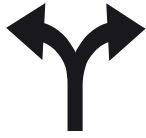

5

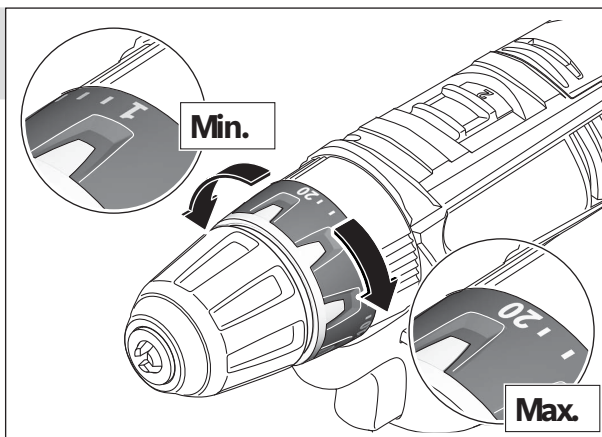

6

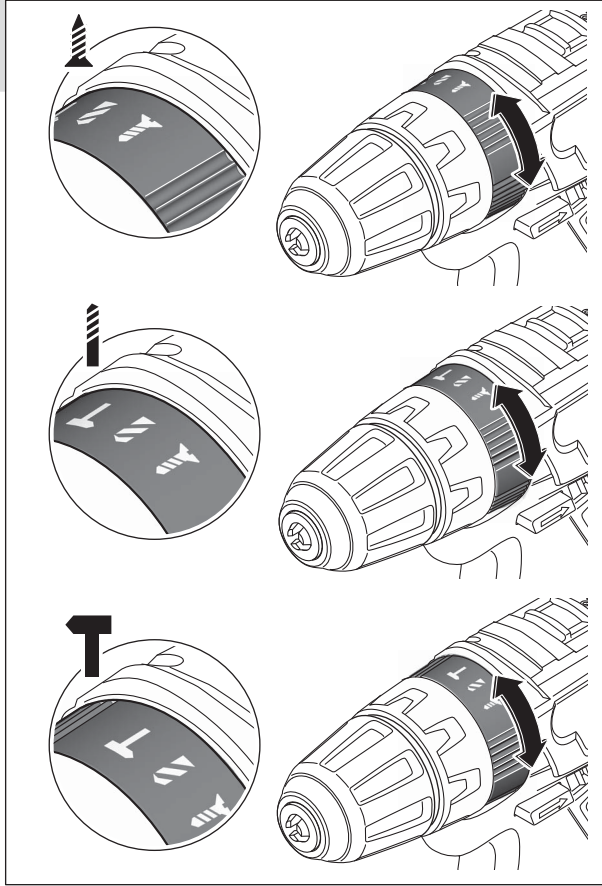

7

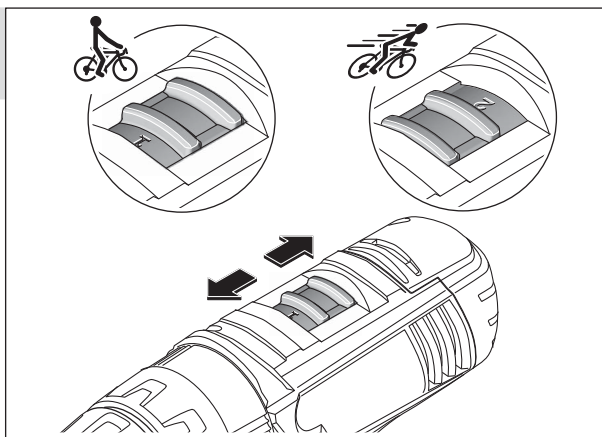
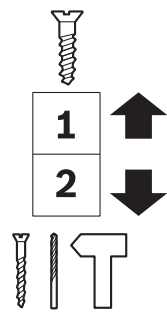

10 |

8

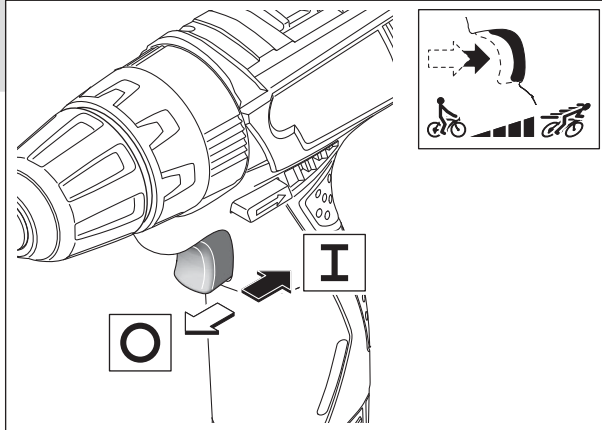
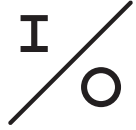

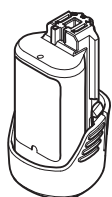

GBA 12V...

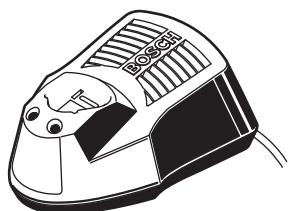

**GAL 1230 CV
(12 V)**



**GAL 1215 CV
(12 V)**

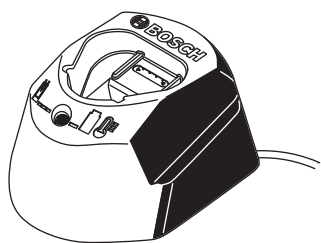

**GAL 1210 CV
(12 V)**



以下各页勿打印！

***Following pages
are NOT for printing!***

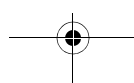
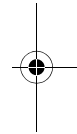
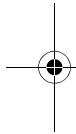

English

General Power Tool Safety Warnings

⚠ WARNING Read all safety warnings and all instructions. Failure to follow the warnings and instructions may result in electric shock, fire and/or serious injury.

Save all warnings and instructions for future reference.

The term "power tool" in the warnings refers to your mains-operated (corded) power tool or battery-operated (cordless) power tool.

Work area safety

- ▶ **Keep work area clean and well lit.** Cluttered or dark areas invite accidents.
- ▶ **Do not operate power tools in explosive atmospheres, such as in the presence of flammable liquids, gases or dust.** Power tools create sparks which may ignite the dust or fumes.
- ▶ **Keep children and bystanders away while operating a power tool.** Distractions can cause you to lose control.

Electrical safety

- ▶ **Power tool plugs must match the outlet. Never modify the plug in any way. Do not use any adapter plugs with earthed (grounded) power tools.** Unmodified plugs and matching outlets will reduce risk of electric shock.
- ▶ **Avoid body contact with earthed or grounded surfaces, such as pipes, radiators, ranges and refrigerators.** There is an increased risk of electric shock if your body is earthed or grounded.
- ▶ **Do not expose power tools to rain or wet conditions.** Water entering a power tool will increase the risk of electric shock.
- ▶ **Do not abuse the cord. Never use the cord for carrying, pulling or unplugging the power tool. Keep cord away from heat, oil, sharp edges and moving parts.** Damaged or entangled cords increase the risk of electric shock.
- ▶ **When operating a power tool outdoors, use an extension cord suitable for outdoor use.** Use of a cord suitable for outdoor use reduces the risk of electric shock.
- ▶ **If operating a power tool in a damp location is unavoidable, use a residual current device (RCD) protected supply.** Use of an RCD reduces the risk of electric shock.

Personal safety

- ▶ **Stay alert, watch what you are doing and use common sense when operating a power tool. Do not use a power tool while you are tired or under the influence of drugs, alcohol or medication.** A moment of inattention while operating power tools may result in serious personal injury.
- ▶ **Use personal protective equipment. Always wear eye protection.** Protective equipment such as dust mask, non-skid safety shoes, hard hat, or hearing protection

used for appropriate conditions will reduce personal injuries.

- ▶ **Prevent unintentional starting. Ensure the switch is in the off-position before connecting to power source and/or battery pack, picking up or carrying the tool.** Carrying power tools with your finger on the switch or energising power tools that have the switch on invites accidents.
- ▶ **Remove any adjusting key or wrench before turning the power tool on.** A wrench or a key left attached to a rotating part of the power tool may result in personal injury.
- ▶ **Do not overreach. Keep proper footing and balance at all times.** This enables better control of the power tool in unexpected situations.
- ▶ **Dress properly. Do not wear loose clothing or jewellery. Keep your hair, clothing and gloves away from moving parts.** Loose clothes, jewellery or long hair can be caught in moving parts.
- ▶ **If devices are provided for the connection of dust extraction and collection facilities, ensure these are connected and properly used.** Use of dust collection can reduce dust-related hazards.

Power tool use and care

- ▶ **Do not force the power tool. Use the correct power tool for your application.** The correct power tool will do the job better and safer at the rate for which it was designed.
- ▶ **Do not use the power tool if the switch does not turn it on and off.** Any power tool that cannot be controlled with the switch is dangerous and must be repaired.
- ▶ **Disconnect the plug from the power source and/or the battery pack from the power tool before making any adjustments, changing accessories, or storing power tools.** Such preventive safety measures reduce the risk of starting the power tool accidentally.
- ▶ **Store idle power tools out of the reach of children and do not allow persons unfamiliar with the power tool or these instructions to operate the power tool.** Power tools are dangerous in the hands of untrained users.
- ▶ **Maintain power tools. Check for misalignment or binding of moving parts, breakage of parts and any other condition that may affect the power tool's operation. If damaged, have the power tool repaired before use.** Many accidents are caused by poorly maintained power tools.
- ▶ **Keep cutting tools sharp and clean.** Properly maintained cutting tools with sharp cutting edges are less likely to bind and are easier to control.
- ▶ **Use the power tool, accessories and tool bits etc. in accordance with these instructions, taking into account the working conditions and the work to be performed.** Use of the power tool for operations different from those intended could result in a hazardous situation.

14 | English

Battery tool use and care

- ▶ **Recharge only with the charger specified by the manufacturer.** A charger that is suitable for one type of battery pack may create a risk of fire when used with another battery pack.
- ▶ **Use power tools only with specifically designated battery packs.** Use of any other battery packs may create a risk of injury and fire.
- ▶ **When battery pack is not in use, keep it away from other metal objects, like paper clips, coins, keys, nails, screws or other small metal objects, that can make a connection from one terminal to another.** Shorting the battery terminals together may cause burns or a fire.
- ▶ **Under abusive conditions, liquid may be ejected from the battery; avoid contact. If contact accidentally occurs, flush with water. If liquid contacts eyes, additionally seek medical help.** Liquid ejected from the battery may cause irritation or burns.

Service

- ▶ **Have your power tool serviced by a qualified repair person using only identical replacement parts.** This will ensure that the safety of the power tool is maintained.

Safety Warnings for Drills and Screwdrivers

- ▶ **Wear ear protectors when impact drilling.** Exposure to noise can cause hearing loss.
- ▶ **Use auxiliary handle(s), if supplied with the tool.** Loss of control can cause personal injury.
- ▶ **Hold power tool by insulated gripping surfaces when performing an operation where the cutting accessory or fastener may contact hidden wiring.** Cutting accessory and fasteners contacting a "live" wire may make exposed metal parts of the power tool "live" and could give the operator an electric shock.
- ▶ **Use appropriate detectors to determine if utility lines are hidden in the work area or call the local utility company for assistance.** Contact with electric lines can lead to fire and electric shock. Damaging a gas line can lead to explosion. Penetrating a water line causes property damage.
- ▶ **Switch off the power tool immediately when the tool insert jams. Be prepared for high reaction torque that can cause kickback.** The tool insert jams when:
 - the power tool is subject to overload or
 - it becomes wedged in the workpiece.
- ▶ **Hold the machine with a firm grip.** High reaction torque can briefly occur while driving in and loosening screws.
- ▶ **Secure the workpiece.** A workpiece clamped with clamping devices or in a vice is held more secure than by hand.
- ▶ **Always wait until the machine has come to a complete stop before placing it down.** The tool insert can jam and lead to loss of control over the power tool.

- ▶ **Do not open the battery.** Danger of short-circuiting.



Protect the battery against heat, e. g., against continuous intense sunlight, fire, water, and moisture. Danger of explosion.













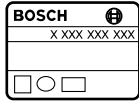

- ▶ **In case of damage and improper use of the battery, vapours may be emitted. Ventilate the area and seek medical help in case of complaints.** The vapours can irritate the respiratory system.
- ▶ **Use the battery only in conjunction with your Bosch power tool.** This measure alone protects the battery against dangerous overload.
- ▶ **The battery can be damaged by pointed objects such as nails or screwdrivers or by force applied externally.** An internal short circuit can occur and the battery can burn, smoke, explode or overheat.









Additional Safety and Working Instructions

- ▶ **Dust from materials such as lead-containing coatings, some wood types, minerals and metal can be harmful to one's health and cause allergic reactions, lead to respiratory infections and/or cancer.** Materials containing asbestos may only be worked by specialists.
 - Provide for good ventilation of the working place.
 - It is recommended to wear a P2 filter-class respirator.
 Observe the relevant regulations in your country for the materials to be worked.
- ▶ **Prevent dust accumulation at the workplace.** Dust can easily ignite.
- ▶ **The battery is supplied partially charged. To ensure full battery capacity, completely charge the battery in the battery charger before using for the first time.**
- ▶ **Read the operating instructions of the battery charger.**
- ▶ **Apply the power tool to the screw only when it is switched off.** Rotating tool inserts can slip off.
- ▶ **Adjust the gear switch only when the machine is at a complete stop.**
- ▶ **If the gear switch cannot be pushed to the stop, turn the drill chuck a little.**

Symbols

The following symbols are important for reading and understanding the operating instructions. Please take note of the symbols and their meaning. The correct interpretation of the symbols will help you to use the machine in a better and safer manner.

| Symbol | Meaning |
|---|--|
|  | GSB 120-Li: Combination Cordless Drill Grey-marked area: Handle (insulated gripping surface) |
|  | Article number |
|  | Read all safety warnings and all instructions |
|  | Before any work on the machine itself, remove the battery |
|  | Always wear ear protection. |
|  | Movement direction |
|  | Reaction direction |
|  | Right/left rotation |
|  | Screwdriving |
|  | Drilling without impact |
|  | Impact drilling |
|  | Low speed |
|  | High speed |
| I | Switching On |
| O | Switching Off |
| U | Rated voltage |
| n_0 1 | No-load speed (1. gear) |
| n_0 2 | No-load speed (2. gear) |
| n_s | Impact rate |
| M | Maximum torque according to ISO 5393 |

| Symbol | Meaning |
|--|--|
|  | Brickwork |
|  | Metal |
|  | Wood |
| \emptyset | Drilling diameter, max. |
|  | Max. screw dia. |
|  | Chuck clamping range |
|  | Weight according to EPTA-Procedure 01:2014 |
| * | Value dependent of the battery pack being used |
| T_1 | Permitted ambient temperature during charging |
| T_2 | Permitted ambient temperature during operation* and storage * Limited performance at temperatures $< 0^\circ\text{C}$ |
|  | Recommended batteries |
|  | Recommended chargers |

Delivery Scope

Combination cordless drill.
Battery, application tools and other accessories shown or described are not part of the standard delivery scope.
A complete overview of accessories can be found in our accessories program.

Intended Use

The machine is intended for driving in and loosening screws as well as for drilling in wood, metal, ceramic and plastic and for impact drilling in brick, brickwork and masonry.
The light of this power tool is intended to illuminate the power tool's direct area of working operation and is not suitable for household room illumination.

Technical Data

The technical data of the machine are listed in the table on page 6.
Please observe the article number on the type plate of your machine. The trade names of the individual machines may vary.

16 | English

Mounting and Operation

| Action | Figure | Page |
|------------------------------------|--------|------|
| Removing the battery | 1 | 7 |
| Inserting the battery | 2 | 7 |
| Mounting application tools | 3 | 7 |
| Reversing the rotational direction | 4 | 8 |
| Setting the torque | 5 | 8 |
| Setting the operating mode | 6 | 9 |
| Gear selection, mechanical | 7 | 9 |
| Switching On and Off | 8 | 10 |
| Selecting Accessories | - | 11 |

Maintenance and Cleaning

- For safe and proper working, always keep the machine and ventilation slots clean.

After-sales Service and Application Service

Our after-sales service responds to your questions concerning maintenance and repair of your product as well as spare parts. Exploded views and information on spare parts can also be found under:

www.bosch-pt.com

Bosch's application service team will gladly answer questions concerning our products and their accessories.

In all correspondence and spare parts orders, please always include the 10-digit article number given on the nameplate of the product.

People's Republic of China

China Mainland

Bosch Power Tools (China) Co., Ltd.
567, Bin Kang Road
Bin Jiang District 310052
Hangzhou, P.R. China
Service Hotline: 4008268484
Fax: (0571) 87774502
E-Mail: contact.ptcn@cn.bosch.com
www.bosch-pt.com.cn

HK and Macau Special Administrative Regions

Robert Bosch Hong Kong Co. Ltd.
21st Floor, 625 King's Road
North Point, Hong Kong
Customer Service Hotline: +852 2101 0235
Fax: +852 2590 9762
E-Mail: info@hk.bosch.com
www.bosch-pt.com.hk

Indonesia

PT Robert Bosch
Palma Tower 10th Floor
Jl. RA Kartini II-S Kaveling 6 Sek II
Pondok Pinang, Kebayoran Lama
Jakarta Selatan 12310
Indonesia
Tel.: (021) 3005 5800
Fax: (021) 3005 5801
E-Mail: boschpowertools@id.bosch.com
www.bosch-pt.co.id

Philippines

Robert Bosch, Inc.
28th Floor Fort Legend Towers,
3rd Avenue corner 31st Street,
Fort Bonifacio Global City,
1634 Taguig City, Philippines
Tel.: (02) 8703871
Fax: (02) 8703870
matheus.contiero@ph.bosch.com
www.bosch-pt.com.ph

Bosch Service Center:
9725-27 Kamagong Street
San Antonio Village
Makati City, Philippines
Tel.: (02) 8999091
Fax: (02) 8976432
E-Mail: rosalie.dagdagan@ph.bosch.com

Malaysia

Robert Bosch Sdn. Bhd.
No. 8A, Jalan 13/6
G.P.O. Box 10818
46200 Petaling Jaya
Selangor, Malaysia
Tel.: (03) 79663194
Fax: (03) 79583838
E-Mail: cheehoe.on@my.bosch.com
Toll-Free: 1800 880188
www.bosch-pt.com.my

Thailand

Robert Bosch Ltd.
Liberty Square Building
No. 287, 11 Floor
Silom Road, Bangrak
Bangkok 10500
Tel.: 02 6393111
Fax: 02 2384783
Robert Bosch Ltd., P. O. Box 2054
Bangkok 10501, Thailand
www.bosch.co.th

Bosch Service – Training Centre
 La Salle Tower Ground Floor Unit No.2
 10/11 La Salle Moo 16
 Srinakharin Road
 Bangkaew, Bang Plee
 Samutprakarn 10540
 Thailand
 Tel.: 02 7587555
 Fax: 02 7587525

Singapore

Powerwell Service Centre Ptd Ltd
 65 Ubi Crescent, #06-03 Hola Centre
 Singapore 408559
 Tel.: 6746 9770/71
 Fax: 6746 9760
 E-Mail: powerwellsc@gmail.com
 Toll-Free: 1800 3338333
 www.bosch-pt.com.sg

Vietnam

Robert Bosch Vietnam Co. Ltd
 13th Floor, 194 Golden Building
 473 Dien Bien Phu Street
 Ward 25, Binh Thanh District
 84 Ho Chi Minh City
 Vietnam
 Tel.: (08) 6258 3690
 Fax: (08) 6258 3692
 Hotline: (08) 6250 8555
 E-Mail: tuvankhachhang-pt@vn.bosch.com
 www.bosch-pt.com.vn
 www.baohanhbosch-pt.com.vn

Australia, New Zealand and Pacific Islands

Robert Bosch Australia Pty. Ltd.
 Power Tools
 Locked Bag 66
 Clayton South VIC 3169
 Customer Contact Center
 Inside Australia:
 Phone: (01300) 307044
 Fax: (01300) 307045
 Inside New Zealand:
 Phone: (0800) 543353
 Fax: (0800) 428570
 Outside AU and NZ:
 Phone: +61 3 95415555
 www.bosch-pt.com.au
 www.bosch-pt.co.nz

Egypt

Unimar
 20 Markaz kadmat
 El tagmoa EL Aoul – New Cairo
 Tel: +2 02 224 76091 - 95 / + 2 02 224 78072 - 73
 Fax: +2 02 224 78075
 E-Mail: adelzaki@unimaregypt.com

Ethiopia

Forever plc
 Kebele 2,754, BP 4806,
 Addis Ababa, Ethiopia
 Tel: +251 111 560 600, +251 111 560 600
 E-Mail: foreverplc@ethionet.et

Nigeria

C. Woermann Ltd.
 P.O. Box 318
 6, Badejo Kalesanwo Street
 Matori Industrial Estate
 Lagos, Nigeria
 Tel: +234 17 736 498, +234 17 730 904
 E-Mail: d.kornemann@woermann-nigeria.com

Republic of South Africa

Customer service

Hotline: (011) 6519600

Gauteng – BSC Service Centre

35 Roper Street, New Centre
 Johannesburg
 Tel.: (011) 4939375
 Fax: (011) 4930126
 E-Mail: bsctools@icon.co.za

KZN – BSC Service Centre

Unit E, Almar Centre
 143 Crompton Street
 Pinetown
 Tel.: (031) 7012120
 Fax: (031) 7012446
 E-Mail: bsc.dur@za.bosch.com

Western Cape – BSC Service Centre

Democracy Way, Prosperity Park
 Milnerton
 Tel.: (021) 5512577
 Fax: (021) 5513223
 E-Mail: bsc@zsd.co.za

Bosch Headquarters

Midrand, Gauteng
 Tel.: (011) 6519600
 Fax: (011) 6519880
 E-Mail: rbsa-hq.pts@za.bosch.com

Transport

The contained lithium-ion batteries are subject to the Dangerous Goods Legislation requirements. The user can transport the batteries by road without further requirements.

When being transported by third parties (e. g.: air transport or forwarding agency), special requirements on packaging and labelling must be observed. For preparation of the item being shipped, consulting an expert for hazardous material is required.

Dispatch batteries only when the housing is undamaged. Tape or mask off open contacts and pack up the battery in such a manner that it cannot move around in the packaging. Please also observe possibly more detailed national regulations.



18 | English

Disposal



The machine, rechargeable batteries, accessories and packaging should be sorted for environmental-friendly recycling.

Do not dispose of power tools and batteries/rechargeable batteries into household waste!

Subject to change without notice.

