



GLM 150 C Professional



Robert Bosch Power Tools GmbH
70538 Stuttgart
GERMANY

www.bosch-pt.com

1 609 92A 5G8 (2019.09) 0 / 73



1 609 92A 5G8

- en Original instructions
- zh 原始使用說明書
- ko 사용 설명서 원본
- th หนังสือคู่มือการใช้งานฉบับต้นแบบ
- id Petunjuk-Petunjuk untuk Penggunaan Orisinal
- vi Bản gốc hướng dẫn sử dụng



English	Page	10
繁體中文	頁	22
한국어	페이지	30
ไทย	หน้า	39
Bahasa Indonesia	Halaman	51
Tiếng Việt	Trang	61

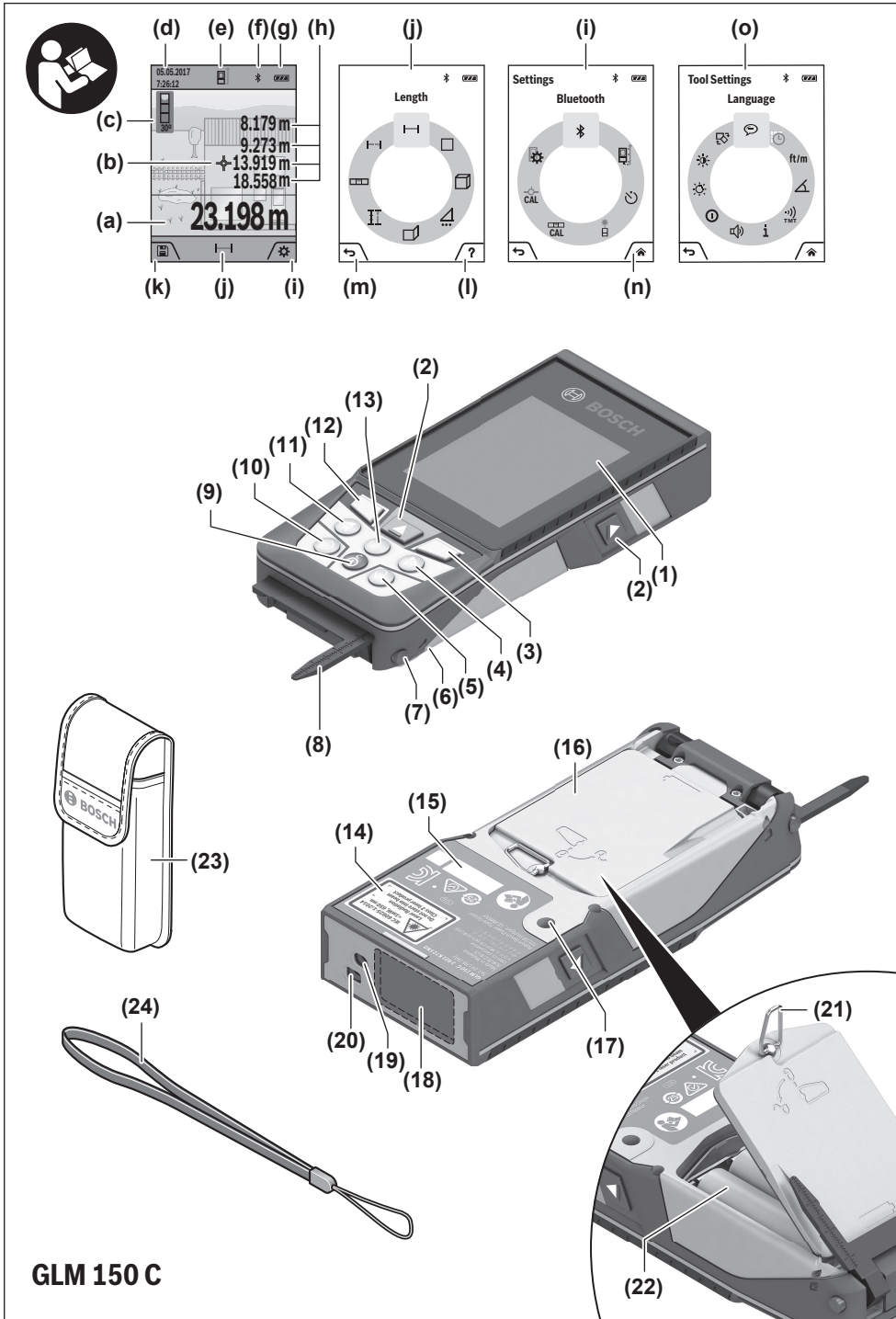

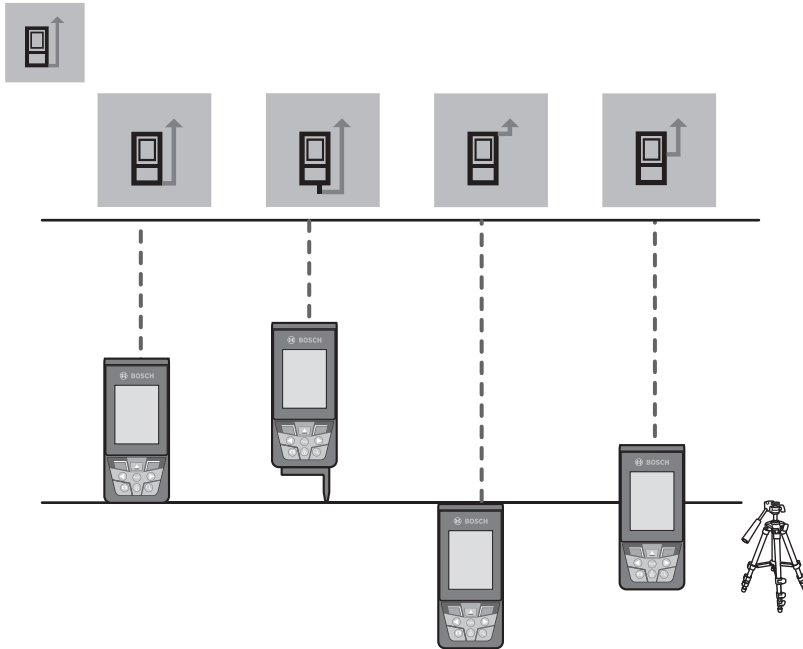
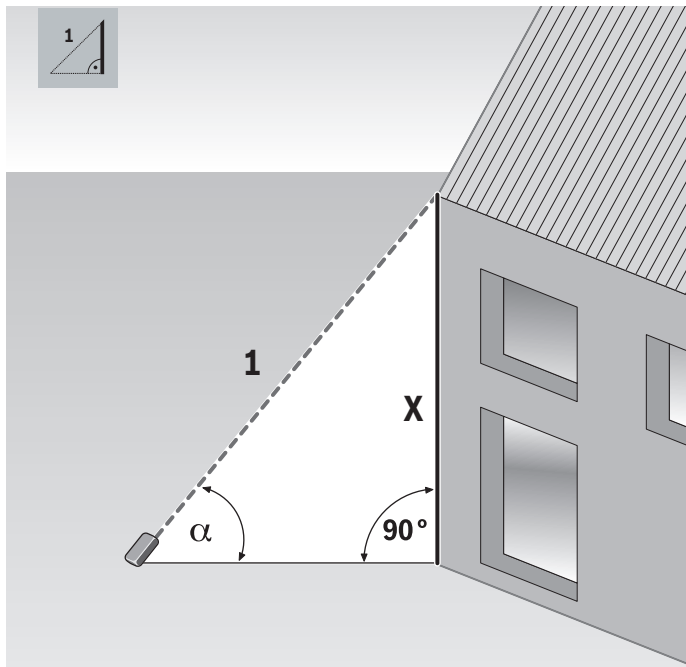
A**B**

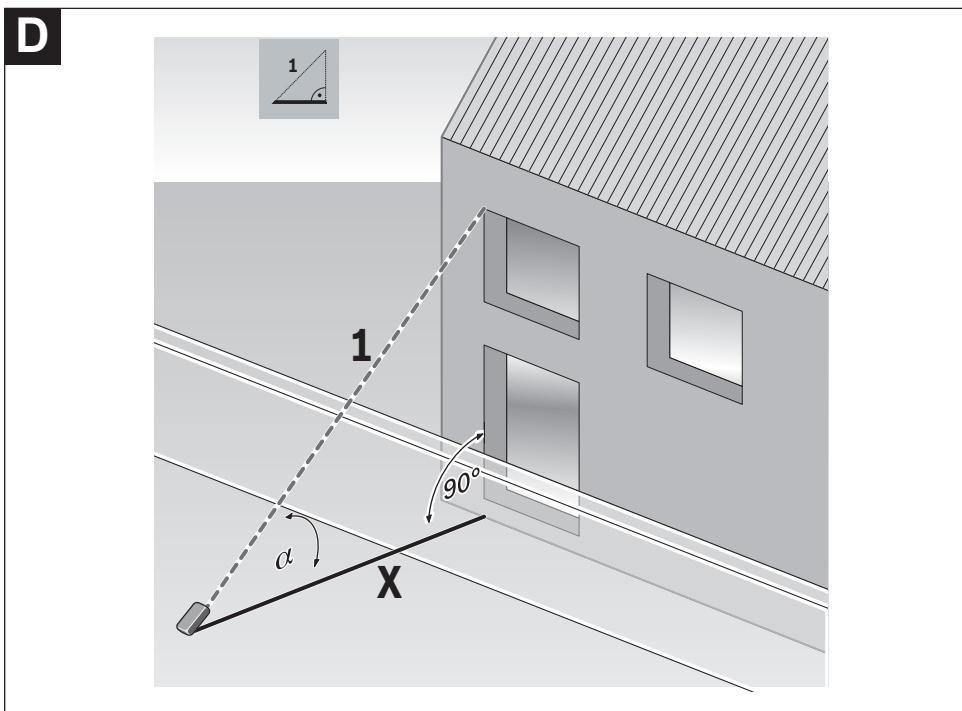
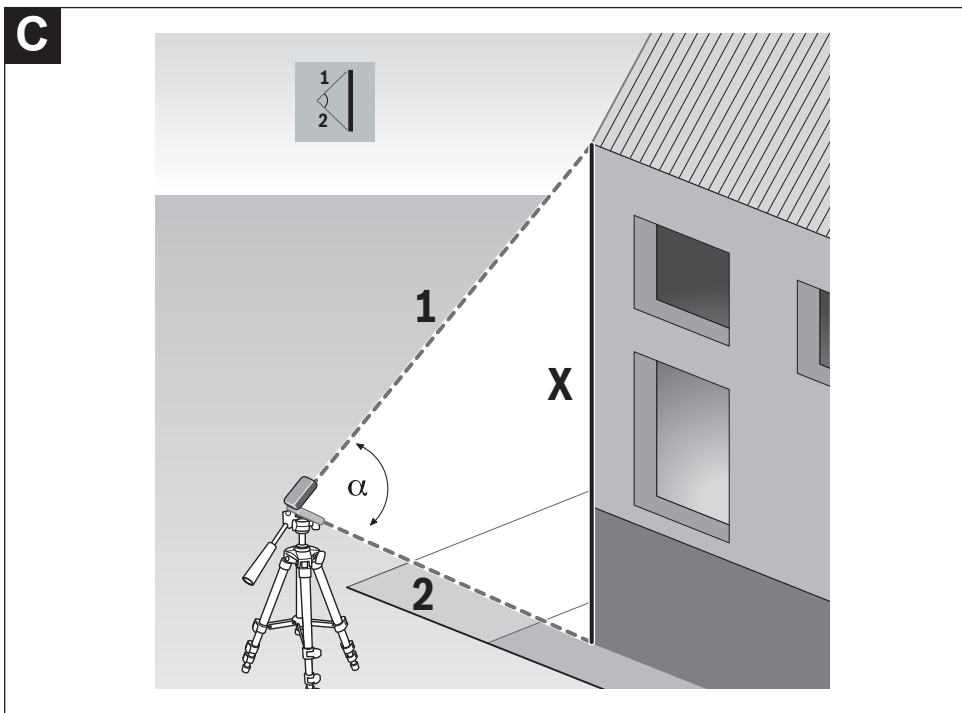

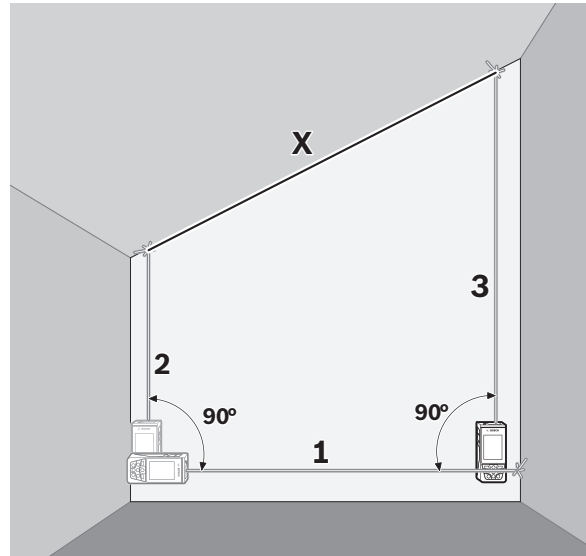
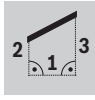
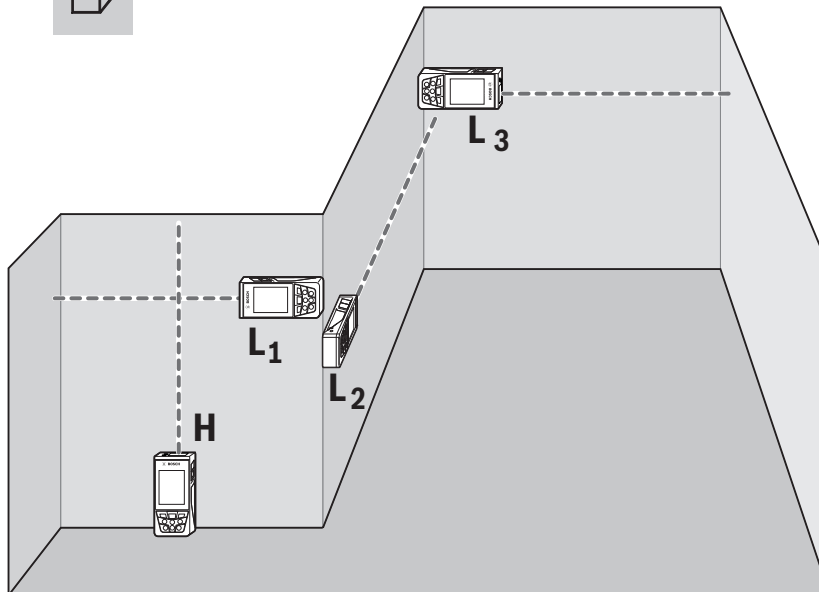
E**F**

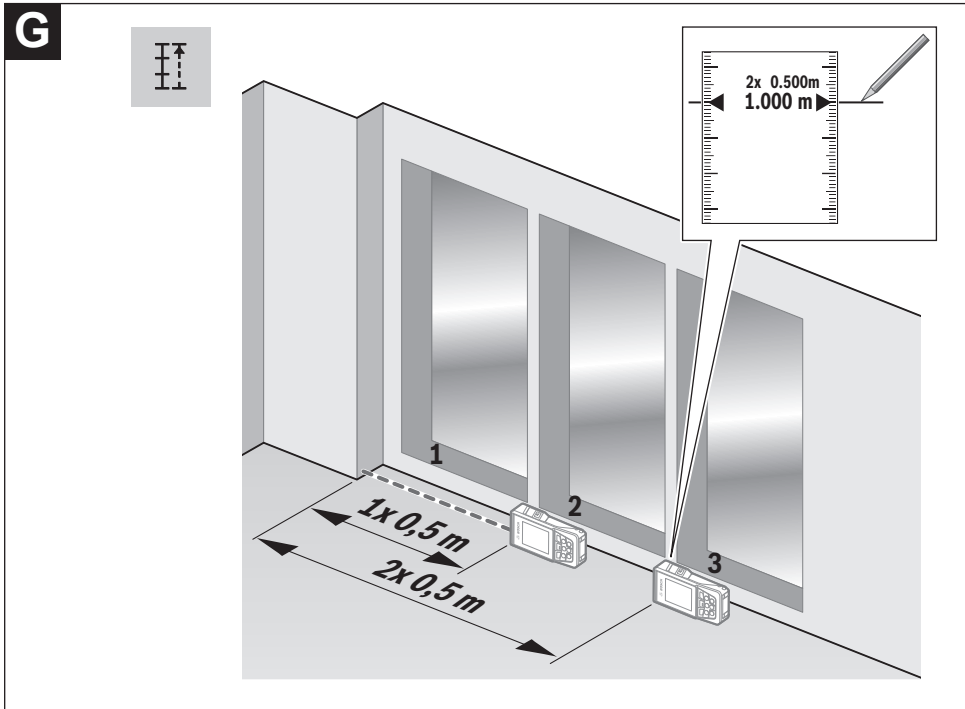

H

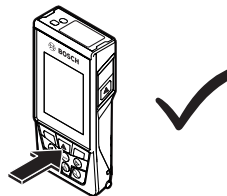
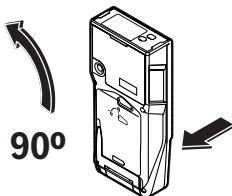
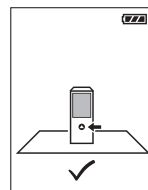
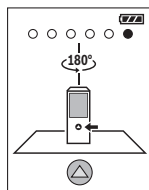
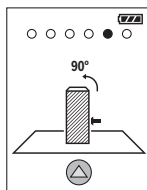
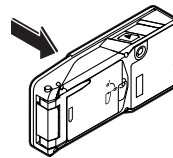
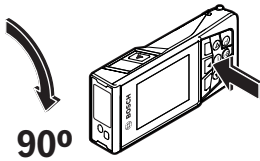
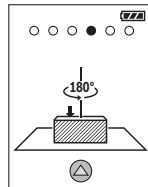
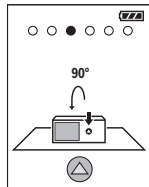
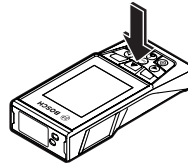
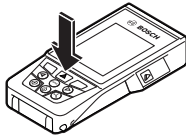
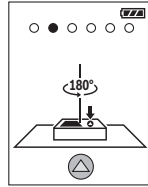
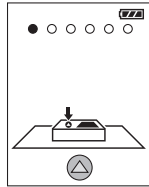

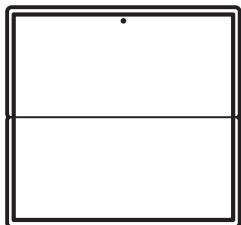

(25)

2 607 001 391



(26)

1 608 M00 05B

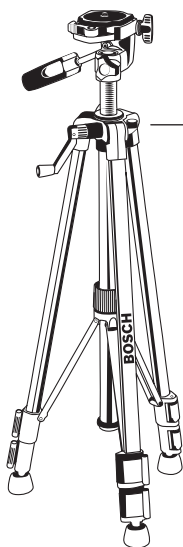

(27)

BT 150
0 601 096 B00

English

Safety Instructions



All instructions must be read and observed in order for the measuring tool to function safely. The safeguards integrated into the measuring tool may be compromised if the measuring tool is not used in accordance with these instructions. Never make warning signs on the measuring tool unrecognisable. **SAVE THESE INSTRUCTIONS FOR FUTURE REFERENCE AND INCLUDE THEM WITH THE MEASURING TOOL WHEN TRANSFERRING IT TO A THIRD PARTY.**

- ▶ **Warning! If operating or adjustment devices other than those specified here are used or other procedures are carried out, this can lead to dangerous exposure to radiation.**
- ▶ **The measuring tool is delivered with a warning label (marked in the illustration of the measuring tool on the graphics page).**
- ▶ **If the text on the warning label is not in your native language, cover it with the label supplied, which is in your language, before initial commissioning.**



Do not direct the laser beam at persons or animals and do not stare into the direct or reflected laser beam yourself. You could blind somebody, cause accidents or damage your eyes.

- ▶ **If laser radiation hits your eye, you must close your eyes and immediately turn your head away from the beam.**
- ▶ **Do not make any modifications to the laser equipment.**
- ▶ **Do not use the laser goggles as protective goggles.** The laser goggles make the laser beam easier to see; they do not protect you against laser radiation.
- ▶ **Do not use the laser goggles as sunglasses or while driving.** The laser goggles do not provide full UV protection and impair your ability to see colours.
- ▶ **Have the measuring tool serviced only by a qualified specialist using only original replacement parts.** This will ensure that the safety of the measuring tool is maintained.
- ▶ **Do not let children use the laser measuring tool unsupervised.** They could accidentally dazzle someone.
- ▶ **Do not use the measuring tool in explosive atmospheres which contain flammable liquids, gases or dust.** Sparks may be produced inside the measuring tool, which can ignite dust or fumes.
- ▶ **Caution! Using the measuring tool with Bluetooth® can cause faults to occur in other devices and systems, aeroplanes and medical devices (e.g. pacemakers, hearing aids). Also, damage to people and animals in the immediate vicinity cannot be completely ex-**

cluded. **Do not use the measuring tool with Bluetooth® in the vicinity of medical devices, petrol stations, chemical plants, areas with a potentially explosive atmosphere and in blasting areas. Do not use the measuring tool with Bluetooth® on aeroplanes. Avoid using the product near your body for extended periods.**

The Bluetooth® word mark and logos are registered trademarks owned by Bluetooth SIG, Inc. and any use of such marks by Robert Bosch Power Tools GmbH is under license.

Product Description and Specifications

Please observe the illustrations at the beginning of this operating manual.

Intended Use

The measuring tool is intended for measuring distances, lengths, heights, clearances and inclines, and for calculating areas and volumes.

The measuring results can be transferred to other devices via Bluetooth®.

The measuring tool is suitable for indoor and outdoor use.

Product features



The numbering of the product features shown refers to the illustration of the measuring tool on the graphic page.

- (1) Display
- (2) Measuring button [▲] (can be used at the front or side)
- (3) Soft key [■]
- (4) Plus button [+]/Select to the right
- (5) Zoom button
- (6) Carrying strap lug
- (7) Measuring pin release button
- (8) Measuring pin
- (9) On/off/delete button [⓪]
- (10) Viewfinder button
- (11) Minus button [-]/Select to the left
- (12) Soft key [■]
- (13) Function button [Func]
- (14) Laser warning label
- (15) Serial number
- (16) Battery compartment cover
- (17) 1/4" tripod socket
- (18) Reception lens
- (19) Laser beam output
- (20) Camera
- (21) Rotary lock
- (22) Batteries

- (23) Protective bag
- (24) Carrying strap
- (25) Laser target plate^{A)}
- (26) Laser viewing glasses^{A)}
- (27) Tripod^{A)}

A) **Accessories shown or described are not included with the product as standard. You can find the complete selection of accessories in our accessories range.**

Display elements

- (a) Result line
- (b) Target display (crosshairs)
- (c) Display tilt angle
- (d) Date/time
- (e) Reference level of measurement
- (f) Connection status
 -  Bluetooth® not activated
 -  Bluetooth® activated, connection established
- (g) Battery indicator
- (h) Measured value lines
- (i) Settings (soft key)
- (j) Selected measuring function
- (k) Internal memory (soft key)
- (l) Integrated help function (soft key)
- (m) Back (soft key)
- (n) Start screen (soft key)
- (o) Tool settings

Technical data

Digital laser measure	GLM 150 C
Article number	3 601 K72 F..
Measuring range (typical)	0.08–150 m ^{A)}
Measuring range (typical, unfavourable conditions)	0.08–60 m ^{B)}
Measuring accuracy (typical)	±1.5 mm ^{A)}
Measuring accuracy (typical, unfavourable conditions)	±3.0 mm ^{B)}
Smallest display unit	0.5 mm
Indirect distance measurement and level	
Measuring range	0°–360° (4 x 90°)
Grade measurement	
Measuring range	0°–360° (4 x 90°)
Measuring accuracy (typical)	±0.2 ^{oC)D)E)}
Smallest display unit	0.1°

Digital laser measure GLM 150 C

General

Operating temperature	-10 °C to +45 °C ^{F)}
Storage temperature	-20 °C to +70 °C
Permitted charging temperature range	+5 °C to +40 °C
Relative air humidity max.	90%
Max. altitude	2000 m
Pollution degree according to IEC 61010-1	2 ^{G)}
Laser class	2
Laser type	650 nm, < 1 mW
Laser beam diameter (at 25 °C) approx.	
- 10 m distance	9 mm
- 100 m distance	90 mm
Automatic switch-off after approx.	
- Laser	20 s
- Measuring tool (without measurement)	5 min ^{H)}
Batteries	3 x 1.5 V LR6 (AA)
Weight according to EPTA-Procedure 01:2014	0.23 kg
Dimensions	142 (176) x 64 x 28 mm
Protection rating	IP 54 (dust- and splash-proof)

Data transmission

Bluetooth®	Bluetooth® (4.2 Low Energy) ^{I)}
Operating frequency band	2402–2480 MHz

**Digital laser
measure****GLM 150 C**

Max. transmission power 8 mW

- A) For measurements from the front edge of the measuring tool, this applies for high reflectivity of the target (e.g. a white-painted wall), weak backlighting and 25 °C operating temperature. In addition, a deviation of ±0.05 mm/m must be taken into account.
- B) For measurements from the front edge of the measuring tool, this applies for high reflectivity of the target (e.g. a white-painted wall), and strong backlighting. In addition, a deviation of ±0.15 mm/m must be taken into account.
- C) After calibration at 0° and 90°. Additional pitch error of max. ±0.01%/degree up to 45°. The measurement accuracy refers to the three orientations of the grade measurement calibration, see figure H
- D) At an operating temperature of 25 °C
- E) The left-hand side of the measuring tool serves as the reference level for grade measurement.
- F) In continuous measurement mode, the max. operating temperature is +40 °C.
- G) non-conductive soiling only, whereby occasional temporary conductivity caused by condensation is expected
- H) The automatic switch-off time can be adjusted (to two, five, ten minutes or never).
- I) When using *Bluetooth*® Low Energy devices, it may not be possible to establish a connection depending on the model and operating system. *Bluetooth*® tools must support the GATT profile.

The serial number (15) on the type plate is used to clearly identify your measuring tool.

Fitting

Inserting/Changing the Batteries

It is recommended that you use alkaline manganese batteries to operate the measuring tool.

- Press the release button (7) and fold the measuring pin (8) out by 180°.
- To open the battery compartment cover (16), fold the rotary lock (21) upwards and turn it anti-clockwise by one quarter-turn. Lift up the battery compartment cover using the rotary lock. Insert the batteries. When inserting the batteries, ensure that the polarity is correct according to the illustration on the inside of the battery compartment.
- ▶ **Take the batteries out of the measuring tool when you are not using it for a prolonged period of time.** The batteries can corrode and self-discharge during prolonged storage.
- ▶ **Note:** TrackMyTools can only be used when batteries are inserted.

Operation

Start-Up

- ▶ **Never leave the measuring tool unattended when switched on, and ensure the measuring tool is switched off after use.** Others may be dazzled by the laser beam.

- ▶ **Protect the measuring tool from moisture and direct sunlight.**
- ▶ **Do not expose the measuring tool to any extreme temperatures or variations in temperature.** For example, do not leave it in a car for extended periods of time. In case of large variations in temperature, allow the measuring tool to adjust to the ambient temperature before putting it into operation. The precision of the measuring tool may be compromised if exposed to extreme temperatures or variations in temperature.
- ▶ **Avoid substantial knocks to the measuring tool and avoid dropping it.** Always carry out an accuracy check before continuing work if the measuring tool has been subjected to severe external influences (see "Accuracy check of the distance measurement", page 18).
- ▶ **The measuring tool is equipped with a wireless interface. Local operating restrictions, e.g. in aeroplanes or hospitals, must be observed.**

Switching On/Off

During work, ensure that the reception lens (18), the laser beam output (19) and the camera (20) are not closed off or covered, otherwise correct measurement will not be possible.

- To **switch on** the measuring tool and the laser, briefly press the front or side measuring button (2) [▲].
- To **switch on** the measuring tool without the laser, briefly press the on/off/delete button (9) [⊖].
- ▶ **Do not direct the laser beam at persons or animals and do not stare into the laser beam yourself (even from a distance).**

To **switch off** the laser, briefly press the on/off/delete button (9) [⊖].

To **switch off** the camera, press the viewfinder button (10).

To **switch off** the measuring tool, press and hold the on/off/delete button (9) [⊖].

The measured values and device settings in the memory are retained when you switch the measuring tool off.

Camera

The camera (20) is switched on automatically when the measuring tool is switched on for the first time. To switch it off, press the viewfinder button (10).

The camera setting (on/off) is saved when the measuring tool is switched off.

Optimising visibility of the laser point

Especially when using the measuring tool outdoors, in sunlight and also over long distances indoors, the laser point may not be visible. The visibility of the laser point/measurement point can additionally be improved in order to connect the camera by:

- Setting the display brightness (tool settings)
- Using the zoom by pressing the button (5).

Measuring process

Once switched on, the measuring tool is in the length measurement function. For a different measuring function, press the [Func] button (13). Use the [+] button (4) or the [-] button (11) to select the required measuring function Measuring functions. Activate the measuring function with the [Func] button (13) or with the measuring button (2) [▲].

Once the measuring tool has been switched on, the rear edge of the measuring tool is selected as the reference level for measurement. To change the reference level (see "Selecting the reference level (see figure A)", page 13). Apply the measuring tool to the point at which you want to start the measurement (e.g. wall).

Note: If the measuring tool has been switched on using the on/off/delete button (9) [⏻], briefly press the measuring button (2) [▲] to switch the laser on.

To initiate the measurement, briefly press the measuring button (2) [▲]. Afterwards, the laser beam is switched off. For a further measurement, repeat this process.

With the laser beam continuously switched on and when in the continuous measurement function, the measurement begins the first time you press the measuring button (2) [▲].

► **Do not direct the laser beam at persons or animals and do not stare into the laser beam yourself (even from a distance).**

Note: The measured value typically appears within half a second, and no later than approximately four seconds. The duration of the measurement depends on the distance, the lighting conditions and the reflective properties of the target surface. Upon completion of the measurement, the laser beam is automatically switched off. The continuously switched-on laser beam is not switched off after the measurement Continuous laser beam.

Selecting the reference level (see figure A)

You can choose between four different reference levels for the measurement:

- The rear edge of the measuring tool (e.g. when placing against walls)
- The tip of the measuring pin (8) folded by 180° (e.g. when measuring from a corner)
- The front edge of the measuring tool (e.g. when measuring from a table edge)
- The centre of the thread (17) (e.g. for tripod measurements)

The folding out and in of the measuring pin (8) by 180° is detected automatically and the appropriate reference level is suggested. Confirm the setting by pressing the measuring button (2) [▲].

Select the settings for the measuring tool using the [Func] soft key (3). Use the [+] button (4) or the [-] button (11) to select the reference level and confirm this by pressing the [Func] button (13).

The rear edge of the measuring tool is automatically preset as the reference level every time the measuring tool is switched on.

Continuous laser beam

If necessary, you can switch the measuring tool to continuous laser beam operation. To do this, select the settings for the measuring tool using the soft key (3) [Func]. Use the button (4) [+] or the button (11) [-] to select the continuous laser beam and confirm this by pressing the button (13) [Func].

► **Do not direct the laser beam at persons or animals and do not stare into the laser beam yourself (even from a distance).**

In this setting, the laser beam remains switched on even between measurements; measurement simply requires one brief press of the measuring button (2) [▲].









The continuous laser beam can be switched off again in the settings or automatically when the measuring tool is switched off.

Settings menu

To enter the settings menu (i), briefly press the soft key (3) [Func] or press and hold the button (13) [Func].

Use the button (4) [+] or the button (11) [-] to select the required setting and confirm this by pressing the button (13) [Func]. Select the required setting.

To exit the settings menu, press the on/off/delete button (9) [⏻] or the soft key (12) [Func].

Settings	
	
	Bluetooth®
	Reference level
	Timer function
	Continuous laser beam
	Grade measurement calibration
	Target indicator calibration
	Tool settings

Timer function

The timer function is useful when measuring in hard-to-reach areas, for example, or when the measuring tool should be kept stationary during measurement.

Select the timer function in the settings. Select the required time period between triggering the timer and starting measurement and confirm by pressing the measuring button (2) [▲] or the button (13) [Func].

Then press the measuring button (2) [▲] to switch on the laser beam and focus on the target. Press the measuring button (2) [▲] again to start the measurement. The measurement will begin after the set time period has expired. The measured value is displayed in the result line (a).

The time period between triggering the timer and starting measurement is displayed in the status bar at the top.











Continuous measurement and minimum/maximum measurement are not possible with the timer function enabled.

The timer remains enabled until the measuring tool is switched off or until the timer is switched off in the settings menu.

Tool settings menu

Select the tool settings menu in the settings menu. Use the button **(4) [+]** or the button **(11) [-]** to select the required tool setting and confirm this by pressing the button **(13) [Func]**. Select the required tool settings. To exit the tool settings menu **(o)**, press the on/off/delete button **(9) [⊖]** or the soft key **(12) [■]**.

Tool settings

	
	Language
	Time & date
ft/m	Unit of measurement
	Unit of measurement for angles
	TrackMyTools
i	Tool information
	Tone signals
	Switch-off time
	Dimmer
	Display brightness
	Display orientation

Setting the language

Select the "Language" option in the tool settings menu. Set the required language and confirm this by pressing the **[Func]** button **(13)** or the measuring button **(2) [▲]**.

Setting the date and time

Select the "Time & date" option in the tool settings menu. Set the date and time according to the instructions on the display and confirm these by pressing the **[■]** soft key **(12)**.

Note: The date and time have to be reset after the batteries are changed.

Changing the unit of measurement

Select the unit of measurement option in the tool settings menu. The default unit of measurement is **m** (metres). Set the required unit of measurement and confirm this by pressing the button **(13) [Func]**.

To exit the menu item, press the on/off/delete button **(9) [⊖]** or the soft key **(3) [■]**. The selected tool settings remain saved after you switch off the measuring tool.

Changing the unit of measurement of an angle

Select the option for setting the unit of measurement for angles in the tool settings menu. The default unit of measurement for an angle is ° (degrees).

Set the required unit of measurement for angles and confirm this by pressing the button **(13) [Func]**.

To exit the menu item, press the on/off/delete button **(9) [⊖]** or the soft key **(3) [■]**. The selected tool settings remain saved after you switch off the measuring tool.

TrackMyTools

Select the "TrackMyTools" option in the tool settings menu. Confirm the setting by pressing the **[Func]** button **(13)**.

Initial activation is required. Data can only be transmitted using a suitable app or computer program.

TrackMyTools can be deactivated again at any time.

The TrackMyTools setting (activated/deactivated) is saved when the measuring tool is switched off.

Note: TrackMyTools can only be used when batteries are inserted. To activate TrackMyTools after changing the batteries, the measuring tool must be switched on briefly.

Display illumination

Select the dimmer option in the tool settings menu.

The display illumination is continuously switched on. If you do not press any buttons, the display lighting is dimmed after approximately 30 seconds to preserve the battery.

The time until dimming starts can be adjusted (tool settings).

The brightness of the display can be adjusted to the surrounding conditions in multiple increments (tool settings).

Measuring functions

Note: Integrated help function

Help in the form of an animation is saved in the measuring tool for each measuring function. To access this, select the button **(13) [Func]**, the button **(4) [+]** or button **(11) [-]** and then the soft key **(3) [■]**. The animation shows you the detailed procedure for the selected measuring function.

The animation can be stopped and started again at any time using the soft key **(3) [■]**. You can scroll forwards and backwards using the button **(4) [+]** and button **(11) [-]**.

Measuring length

Select the length measurement mode **l—l**.

To switch on the laser beam, briefly press the measuring button **(2) [▲]**.

To measure, briefly press the measuring button **(2) [▲]**. The measured value will be shown at the bottom of the display.

Repeat the above-mentioned steps for each subsequent measurement. The last measured value is at the bottom of the display, the penultimate measured value is above it, and so on.

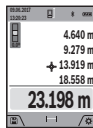

Continuous measurement

In continuous measurement mode, the measuring tool can be moved relative to the target, during which the measured value will be updated every half a second. You can, for example, move a desired distance away from a wall while reading off the current distance at all times.

Select the continuous measurement mode **l—l**.

To switch on the laser beam, briefly press the measuring button **(2) [▲]**.

Move the measuring tool until the required distance value is shown in the display below.

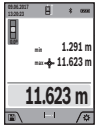

Briefly pressing the measuring button (2) [▲] will interrupt the continuous measurement.

The current measured value will be shown at the bottom of the display. The maximum and minimum measured value appear above it.

Pressing the measuring button (2) [▲] once more will start the continuous measurement again.

Continuous measurement automatically switches off after five minutes.

Area measurement

Select the area measurement mode

Then measure the width and length and height one after the other as with a length measurement. The laser beam remains switched on between the two measurements. The distance to be measured flashes in the indicator for area measurement (see indicator element (j)).



The first measured value is shown at the top of the display.

After the second measurement has been completed, the area will be automatically calculated and displayed. The end result is shown at the bottom of the display, while the individual measured values are shown above it.

Volume measurement

Select the volume measurement mode

Then measure the width, length and depth one after the other as with a length measurement. The laser beam remains switched on between the three measurements. The distance to be measured flashes in the indicator for volume measurement (see display element (j)).

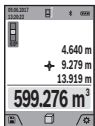

The first measured value is shown at the top of the display.

After the third measurement has been completed, the volume will be automatically calculated and displayed. The end result is shown at the bottom of the display, while the individual measured values are shown above it.

Indirect distance measurement

Select the indirect distance measurement mode

There are four measuring functions available for the indirect distance measurement, each of which is capable of determining different distances.

The indirect distance measurement is used to determine distances that cannot be measured directly, due to an obstacle that would impede the path beam or the absence of a target surface that could serve as a reflector. This measuring procedure can only be employed vertically. Any horizontal deviation will lead to measurement errors.

Note: Indirect distance measurement is always less accurate than direct distance measurement. For application-related reasons, measuring errors can be greater than with direct distance measurement. To improve the accuracy of measurement, we recommend the use of a tripod (accessory).

The laser beam remains switched on between the individual measurements

a) Indirect height measurement (see figure B)

Select the indirect height measurement mode

Ensure that the measuring tool is at the same height as the lower measuring point. Then tilt the measuring tool around the reference level and measure distance **1** as for a length measurement (displayed as a red line).

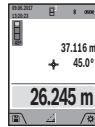

Once the measurement is complete, the result for the required distance **X** is displayed in the result line (a). The measured values for distance **1** and angle **a** can be found in the measured value rows (h).

b) Double indirect height measurement (see figure C)

The measuring tool can indirectly measure all distances that lie in the vertical level of the measuring tool. Select the double indirect height measurement mode

Measure distances **1** and **2** in succession as for a length measurement.

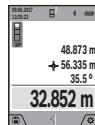

Once the measurement is complete, the result for the required distance **X** is displayed in the result row (a). The measured values for distances **1** and **2** and angle **a** can be found in the measured value rows (h).

Ensure that the reference level for the measurement (e.g. the rear edge of the measuring tool) remains in exactly the same place for all the individual measurements in a single measuring process.

a) Indirect length measurement (see figure D)

Select the indirect length measurement mode

Ensure that the measuring tool is at the same height as the required measuring point. Then tilt the measuring tool around the reference level and measure distance **1** as for a length measurement.

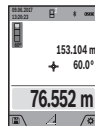

Once the measurement is complete, the result for the required distance **X** is displayed in the result row (a). The measured values for distance **1** and angle **a** can be found in the measured value row (h).

d) Trapezium measurement (see figure E)

The trapezium measurement can be used to determine the length of a roof slope, for example.

Select the trapezium measurement mode

Measure distances **1**, **2** and **3** in succession as for a length measurement. Ensure that the measurement of distance **3** begins exactly at the point where distance **1** ends and that distances **2** and **3** are at right angles to distance **1**.

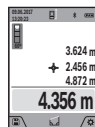

Once the final measurement is complete, the result for the required distance **X** is displayed in the result line (a). The individual measured values can be found in the measured value lines (h).

Wall area measurement (see figure F)

The wall area measurement is used to determine the sum of multiple individual areas with a common height. In the illustrated example, the total area of several walls that have the same ceiling height **H** but different lengths **L** is to be determined.

Select the wall area measurement mode .

Measure the ceiling height **H** as for a length measurement. The measured value is displayed in the top measured-value line. The laser remains switched on.

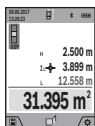

Then measure the length **L**₁ of the first wall. The area is automatically calculated and displayed in the result line **(a)**. The last measured value for length can be found in the bottom measured value line **(h)**. The laser remains switched on.

Now measure the length **L**₂ of the second wall. The individual measured value displayed in the measured value line **(h)** is added to the length **L**₁. The sum of the two lengths (displayed in the middle measured value line **(h)**) is multiplied by the saved height **H**. The total area value is displayed in the result line **(a)**.

You can measure any number of lengths **L**_x, which will be automatically added and multiplied by the height **H**. The requirement for a correct area calculation is that the first measured length (for example the ceiling height **H**) is identical for all sub-areas.

Stake out function (see figure G)

The stake out function repeatedly measures a defined length (distance). These lengths can be transferred to a surface, for example to enable material to be cut into pieces of equal lengths or to install stud walls in a drywall construction. The minimum adjustable length is 0.1 m and the maximum length is 50 m.

Note: The distance from the marking is shown in the display in the stake out function. The reference is **not** the edge of the measuring tool.

Select the stake out function .

Use the button **(4) [+]** or the button **(11) [-]** to set the required length.

Begin the stake out function by pressing the measuring button **(2) [▲]** and slowly move away from the starting point.



The measuring tool continuously measures the distance to the starting point. The defined length and the current measured value are thereby displayed. The lower or upper arrow displays the shortest distance to the next or last marking.

Note: When measuring continuously, you can set a measured value as a defined length by pressing the measuring button **(2) [▲]**.



The left factor specifies how many times the defined length has already been reached. The green arrows on either side of the display indicate the reaching of a length for marking purposes.

Red arrows or red text indicate the actual value when the reference is outside of the display.

Grade measurement/digital spirit level

Select the inclination measurement/digital spirit level .

The measuring tool automatically switches between two states.

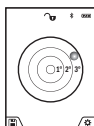

The digital spirit level is used to check the horizontal or vertical alignment of an object (e.g. washing machine, refrigerator, etc.).

When the inclination exceeds 3°, the ball in the display lights up red.

The bottom of the measuring tool is used as the reference level for the digital spirit level.

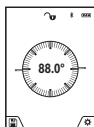

Grade measurement is used to measure a slope or incline (e.g. of stairs, railings, when fitting furniture, laying pipes, etc.).

The left-hand side of the measuring tool serves as the reference level for grade measurement. If the display flashes during measurement, the measuring tool has been tipped too heavily to the side.

Memory functions

The value or end result of each completed measurement is automatically saved.

Memory value display

A maximum of 50 values (measured values or photos with measured values) can be retrieved.

Select the memory function using the soft key **(12) [▼]**.

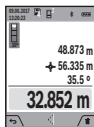

The number of the memory value is shown at the top of the display, the corresponding memory value and the corresponding measuring function are shown at the bottom.



Press the button **(4) [+]** to browse forwards through the saved values.

Press the button **(11) [-]** to browse backwards through the saved values.

If there is no value available in the memory, **0.000** is shown at the bottom of the display and **0** at the top.

The oldest value is located in position 1 in the memory, while the newest value is in position 50 (when 50 memory values are available). When a further value is saved, the oldest value in the memory is always deleted.

Deleting the memory

To open the memory, press the  soft key **(12)**. Press the  soft key **(3)** as often as required to delete the saved measurements in reverse order. To delete all the contents of the memory, press the  soft key **(3)** and the zoom button **(5)** at the same time.

Adding/subtracting values

Measured values or end results can be added or subtracted.

Adding values

The following example describes the addition of areas: Determine an area as described in the section on area measurement (see "Area measurement", page 15).



Press the button **(4)** [+]. The calculated area and the + symbol will be displayed. Press the measuring button **(2)** [▲] to start another area measurement. Measure the area as described in the section on area measurement (see "Area measurement", page 15). Once the second measurement is completed, the result of the second area measurement is displayed below. To show the end result, press the measuring button **(2)** [▲] once more.

Note: In the case of a length measurement, the end result is displayed immediately.

Subtracting values

To subtract values, press the button **(11)** [-]. The subsequent steps are the same as for the section on adding values.

Deleting measured values

Briefly pressing the on/off/delete button **(9)** [⊗] will delete the last measured value in all measuring functions.

Bluetooth® interface

Transmitting data to other devices

The measuring tool is fitted with a *Bluetooth*® module which enables wireless data transfer to certain mobile devices with a *Bluetooth*® interface (e.g. smartphone, tablet).

Information about the system requirements for a *Bluetooth*® connection can be found on the Bosch website at www.bosch-pt.com

► **Further information can be found on the Bosch product page.**

When transmitting data by means of *Bluetooth*®, time lags may occur between the mobile device and the measuring tool. This can be due to the distance between the two devices or the measurement object itself.

Activating the *Bluetooth*® interface for transmitting data to a mobile device

The *Bluetooth*® interface is activated in the settings. To activate the *Bluetooth*® signal, press the button **(4)** [+]. Ensure that the *Bluetooth*® interface is activated on your mobile device.

The Bosch Measuring Master app is specially designed to extend the range of functions of the mobile device and make data easier to process. This can be downloaded from the respective store of the device.

The connection between the mobile device and the measuring tool is established after the Bosch application has started. If multiple active measuring tools are found, select the appropriate measuring tool using the serial number. You can find the serial number **(15)** on your measuring tool's type plate.

The connection status, as well as the active connection **(f)**, are shown in the display **(1)** of the measuring tool.

Deactivating the *Bluetooth*® interface

The *Bluetooth*® connection is deactivated in the settings. To deactivate the *Bluetooth*® signal, press the button **(11)** [-] or switch off the measuring tool.

Practical advice

- **Further information can be found on the Bosch product page.**
- **The measuring tool is equipped with a wireless interface. Local operating restrictions, e.g. in aeroplanes or hospitals, must be observed.**

General advice

The reception lens **(18)**, the laser beam output **(19)** and the camera **(20)** must not be covered during measurement.

The measuring tool must not be moved while a measurement is being taken. For this reason, place the measuring tool against or on a firm surface whenever possible.

Influences on the measuring range

The measuring range depends on the lighting conditions and the reflective properties of the target surface. For better visibility of the laser beam in strong extraneous light, use the integrated camera **(20)**, the laser viewing glasses **(26)** (accessory) and the laser target plate **(25)** (accessory) or shade the target area.

Influences on the measurement result

Due to physical effects, the possibility of inaccurate measurements when measuring various surfaces cannot be excluded. These include:

- Transparent surfaces (e.g. glass, water)
 - Reflective surfaces (e.g. polished metal, glass)
 - Porous surfaces (e.g. insulating materials)
 - Structured surfaces (e.g. roughcast, natural stone).
- If necessary, use the laser target plate **(25)** (accessory) on these surfaces.

Inaccurate measurements are also possible where the laser is pointed at target surfaces diagonally.

Layers of air at different temperatures and indirectly received reflections can also influence the measured value.

Checking accuracy and calibrating the grade measurement (see figure H)

Regularly check the accuracy of the grade measurement. This is accomplished by means of a reverse measurement. To do this, lay the measuring tool on a table and measure the inclination. Turn the measuring tool by 180° and measure the inclination again. The difference between the displayed values must not exceed 0.3°.

In case of greater deviation, the measuring tool must be recalibrated. To do so, select **CAL** in the settings. Follow the directions on the display.

We recommend that you perform an accuracy check and if necessary a calibration of the measuring tool after extreme

temperature variations and after impact to the tool. After a temperature variation, the measuring tool must acclimatise for a while before calibration is performed.

Accuracy check of the distance measurement

You can check the accuracy of the measuring tool as follows:

- Choose a measuring section of approx. 3 to 10 m in length that is permanently unchanged, the exact length of which is known to you (e.g. room width, door opening). The measurement should be performed under favourable conditions, i.e. the measuring section should be indoors with weak backlighting and the target area of the measurement should be smooth and reflect well (e.g. a white-painted wall).
- Measure the section ten times in succession.

The deviation of the individual measurements from the mean value must not exceed ± 2 mm over the entire measuring section in favourable conditions. Record the measurements in order to be able to compare the accuracy later on.

Checking accuracy and calibrating the target indicator (crosshairs)

Check the accuracy of the alignment of the laser and target indicator on a regular basis.

- Select a bright area at least five metres away with as little illumination as possible (e.g. a white wall) as the target.
- Check whether the laser point is inside the target indicator in the display.

If the laser point is not inside the target indicator, you must recalibrate the target indicator.

To do so, select **CAL** in the settings. Follow the directions on the display.

For longer distances (of approx. more than five metres), a target marker is also superimposed to mark the measuring point.

Working with the tripod (accessory)

The use of a tripod is particularly necessary for larger distances. Place the measuring tool with the 1/4" thread **(17)** on the quick-release plate of the tripod **(27)** or a commercially available camera tripod. Tighten it using the locking screw of the quick-release plate.

Set the reference level for measurements with a tripod in the settings (tripod reference level).

Errors – Causes and Corrective Measures

Cause	Corrective measures
Temperature warning flashes, measurement not possible	
The measuring tool is outside the operating temperature of -10 °C to $+45$ °C (in the con-	Wait until the measuring tool has reached operating temperature.
Display shows "ERROR"	
tinuous measurement function, up to $+40$ °C).	
Addition/subtraction of measured values with different units of measurement.	Only add/subtract measured values with the same units of measurement.
Angle between laser beam and target is too acute.	Increase the angle between the laser beam and the target.
Target surface is too reflective (e.g. mirror) or not reflective enough (e.g. black material), or ambient light is too bright.	Use the laser target plate (25) .
The laser beam output (19) , reception lens (18) or camera (20) are fogged up (e.g. due to a rapid temperature change).	Wipe the laser beam output (19) , reception lens (18) or camera (20) dry with a soft cloth.
Calculated value is larger than $+1,999,999$ or smaller than $-999,999$ m ² /m ³ .	Divide the calculation into intermediate steps.
Display shows "CAL" and "ERROR"	
The calibration of the grade measurement has not been carried out in the right order or has not been carried out in the correct positions.	Repeat the calibration according to the instructions that appear on the display and in the manual.
The surfaces used for calibration were not precisely horizontal or vertical.	Repeat the calibration on a horizontal or vertical surface and check the surfaces beforehand if necessary using a spirit level.
The measuring tool has moved or tilted when the button was pressed.	Repeat the calibration and hold the measuring tool still against the surface when pressing the button.
Measurement result implausible	
Target surface reflection not distinct (e.g. water, glass).	Cover the target surface.
The laser beam output (19) , reception lens (18) or camera (20) is covered.	Keep the laser beam output (19) , reception lens (18) and camera (20) clear.
An incorrect reference level has been set.	Select a reference level that is appropriate for the measurement.
Obstruction in the path of the laser beam.	The laser point must be fully on the target surface.
Bluetooth® cannot be activated	
Batteries too weak.	Change the batteries
No Bluetooth® connection	

Cause	Corrective measures
There is a problem with the <i>Bluetooth</i> ® connection.	<p>Switch <i>Bluetooth</i>® off and back on again on the measuring tool and mobile device.</p> <p>Check the application on your mobile device.</p> <p>Check whether <i>Bluetooth</i>® is activated on your measuring tool and mobile device.</p> <p>Check whether your mobile device has been overloaded.</p> <p>Reduce the distance between the measuring tool and your mobile device.</p> <p>Where possible, ensure that there are no obstructions (e.g. reinforced concrete, metal doors) between the measuring tool and your mobile device. Keep the equipment away from any sources of electromagnetic interference (e.g. WiFi transmitters).</p>



The measuring tool monitors for correct operation in every measurement. If a defect is detected, the display will indicate only the symbol shown opposite. In this case, or if you are unable to rectify an error using the corrective

measures above, send the measuring tool to Bosch customer service via your dealer.

Maintenance and Service

Maintenance and Cleaning

Keep the measuring tool clean at all times.

Never immerse the measuring tool in water or other liquids.

Wipe off any dirt using a damp, soft cloth. Do not use any detergents or solvents.

Clean the reception lens **(18)**, laser beam outlet aperture **(19)** and camera **(20)** particularly carefully: Ensure that there is no dirt on the reception lens, the laser beam outlet aperture or the camera. Only clean the reception lens, the laser beam outlet aperture and the camera with cleaning agents that are also suitable for camera lenses. Do not attempt to remove dirt from the reception lens, laser beam outlet aperture or camera using pointed objects, and do not wipe over the reception lens, laser beam outlet aperture or camera (risk of scratching).

If the measuring tool needs to be repaired, send it off in the protective bag **(23)**.

After-Sales Service and Application Service

Our after-sales service responds to your questions concerning maintenance and repair of your product as well as spare

parts. You can find explosion drawings and information on spare parts at: www.bosch-pt.com

The Bosch product use advice team will be happy to help you with any questions about our products and their accessories.

In all correspondence and spare parts orders, please always include the 10-digit article number given on the nameplate of the product.

Cambodia

Robert Bosch (Cambodia) Co., Ltd
Unit 8BC, GT Tower, 08th Floor, Street 169,
Czechoslovakia Blvd, Sangkat Veal Vong
Khan 7 Makara, Phnom Penh
VAT TIN: 100 169 511
Tel.: +855 23 900 685
Tel.: +855 23 900 660
www.bosch.com.kh

People's Republic of China China Mainland

Bosch Power Tool (China) Co. Ltd.
Bosch Service Center
567, Bin Kang Road
Bin Kang District
Hangzhou, Zhejiang Province
China 310052
Tel.: (0571) 8887 5566 / 5588
Fax: (0571) 8887 6688 x 5566# / 5588#
E-Mail: bsc.hz@cn.bosch.com
www.bosch-pt.com.cn

HK and Macau Special Administrative Regions

Robert Bosch Co. Ltd.
Flat B, 2/F, Yeung Yiu Chung No. 6 Industrial Building,
19 Cheung Shun Street
Cheung Sha Wan
Kowloon, Hong Kong
Customer Service Hotline: +852 2101 0235
Fax: +852 2590 9762
E-Mail: info@hk.bosch.com
www.bosch-pt.com.hk

India

Bosch Service Center
69, Habibullah Road, (Next to PSBB School), T. Nagar
Chennai-600077
Phone: (044) 64561816
Bosch Service Center
18, Community Center
Phase 1, Mayapuri
New Delhi-110064
Phone: (011) 43166190

Indonesia

PT Robert Bosch
Palma Tower 10th Floor
Jalan RA Kartini II-S Kaveling 6
Pondok Pinang, Kebayoran Lama
Jakarta Selatan 12310
Tel.: (21) 3005-5800
www.bosch-pt.co.id

Malaysia

Robert Bosch Sdn. Bhd. (220975-V) PT/SMY
 No. 8A, Jalan 13/6
 46200 Petaling Jaya
 Selangor
 Tel.: (03) 79663194
 Toll-Free: 1800 880188
 Fax: (03) 79583838
 E-Mail: kiathoe.chong@my.bosch.com
 www.bosch-pt.com.my

Pakistan

Robert Bosch Middle East FZE – Pakistan Liaison Office
 2nd Floor Plaza # 10, CCA Block, DHA Phase 5
 Lahore, 54810
 Phone: +92(303)4444311
 Email: Faisal.Khan@bosch.com

Philippines

Robert Bosch, Inc.
 28th Floor Fort Legend Towers,
 3rd Avenue corner 31st Street,
 Fort Bonifacio, Global City,
 1634 Taguig City
 Tel.: (632) 8703871
 Fax: (632) 8703870
 www.bosch-pt.com.ph

Singapore

Powerwell Service Centre Ptd Ltd
 Bosch Authorised Service Centre (Power Tools)
 4012 Ang Mo Kio Ave 10, #01-02 TECHplace
 Singapore 569628
 Tel.: 6452 1770
 Fax: 6452 1760
 E-Mail: ask@powerwellsc.com
 www.powerwellsc.com
 www.bosch-pt.com.sg

Thailand

Robert Bosch Ltd.
 FYI Center Tower 1, 5th Floor,
 2525 Rama IV Road, Klongtoei,
 Bangkok 10110
 Tel.: 02 0128888
 Fax: 02 0645802
 www.bosch.co.th
 Bosch Service – Training Centre
 La Salle Tower Ground Floor Unit No.2
 10/11 La Salle Moo 16
 Srinakharin Road
 Bangkaew, Bang Plee
 Samutprakarn 10540
 Tel.: 02 7587555
 Fax: 02 7587525

Vietnam

Branch of Bosch Vietnam Co., Ltd in HCMC
 14th floor, Deutsches Haus, 33 Le Duan
 Ben Nghe Ward, District 1, Ho Chi Minh City
 Tel.: (028) 6258 3690
 Fax: (028) 6258 3692 - 6258 3694

Hotline: (028) 6250 8555
 Email: tuvankhachhang-pt@vn.bosch.com
 www.bosch-pt.com.vn

Bahrain

EA Juffali and Brothers for Technical Equipment Company.
 Kingdom of Bahrain, Al Aker - Block 0624 - Road 2403 -
 Building 0055D
 Phone: +97317704537
 Fax: +973177045257
 Email: h.berjas@eajb.com.sa

Egypt

RBEG-LLC
 22 Kamal Eldin Hussein
 Sheraton Heliopolis
 11799 Cairo
 E-mail: boschegypt.powertools@eg.bosch.com

Iran

Robert Bosch Iran
 3rd Floor, No 3, Maadiran Building
 Aftab St., Khodami St., Vanak Sq.
 Tehran 1994834571
 Phone: +9821- 86092057

Iraq

Sahba Technology Group
 Al Muthana airport road
 Baghdad
 Phone Bagdad: +964 (0) 7 901 930366
 Phone Dubai: +971 (0) 4 422 1898
 Email: duraid@sahbatechnology.com

Jordan

Roots Arabia – Jordan
 Al-Hurriyah Street, Al-Muqabalein
 Amman 11623, Jordan
 P.O. Box: 110068
 Tel. : +962 6 4398990
 E-mail: bosch@rootsjordan.com

Kuwait

Shuwaikh Industrial Area, Block 1, Plot 16, Street 3rd
 P.O. Box 164 – Safat 13002
 Phone: +965 - 2496 88 88
 Fax: +965 - 2481 08 79
 E-mail: josephkr@aaalmutawa.com

Lebanon

Tehini Hana & Co. S.A.R.L.
 P.O. Box 90-449
 Jdeideh 1202 2040
 Dora-Beirut
 Phone: +9611255211
 Email: service-pt@tehini-hana.com

Libya

El Naser for Workshop Tools
 Swanee Road, Alfalah Area
 Tripoli
 Phone: +218 21 4811184

Oman

Malatan Trading & Contracting LLC
 P.O. Box 131, Ruwi, Muscat
 Postal Code: 112, Sultanate of Oman
 Phone: +968 2479 4035/4089/4901
 Mob: +968-91315465
 Fax: +968 2479 4058
 E-Mail: sudhirkumar@malatan.net

Qatar

International Construction Solutions W L L
 P. O. Box 51, Doha
 Phone: +974 40065458
 Fax: +974 4453 8585
 Email: csd@icsdoha.com

Saudi Arabia

Juffali Technical Equipment Co. (JTECO)
 P.O.Box: 1049 – Jeddah 21431 – KSA
 Jeddah: 00966 (0) 12 692 0770 – Ext 433
 Riyadh: 00966 (0) 11 409 3976 – Ext-30/34/39
 Dammam: 00966 (0) 13 833 9565
 E-mail: M.Zreik@ejab.com.sa

Syria

Dallal Establishment for Power Tools
 Damascus. Baramkeh street - Ibn Amer street,
 Phone: +963112241006 or 009631122414009
 Mobile: 00963991141005
 Email: rita.dallal@hotmail.com

United Arab Emirates

Central Motors & Equipment,
 P.O. Box 26255, Dubai
 Dubai: 00971 (0) 4 3090920/3090930
 Abu Dhabi: 00971 (0) 2 4017745
 Sharjah: 00971 (0) 6 5932777
 Al Ain: 00971 (0) 3 7157419
 E- Mail: Mallappa.Madari@centralmotors.ae

Yemen

Abu Alrejal Trading Corporation
 P.O. Box : 17024 , Zubeiry St.
 Sana'a, Yemen
 Tel: +967-1-20 20 10
 Fax: +967-1-47 19 17
 E-mail: tech-tools@abualrejal.com/yahya@abualrejal.com

Ethiopia

Forever plc
 Kebele 2,754, BP 4806,
 Addis Ababa
 Phone: +251 111 560 600
 Email: foreverplc@ethionet.et

Ghana

Robert Bosch Ghana Limited
 21 Kofi Annan Road Airport Residential Area Accra
 Tel. +233 (0)3027 94616

Kenya

Robert Bosch East Africa Ltd
 Mpaka Road P.O. Box 856
 00606 Nairobi

Nigeria

Robert Bosch Nigeria Ltd.
 52–54 Isaac John Street P.O. Box
 GRA Ikeja – Lagos

Tanzania

Diesel & Autoelectric Service Ltd.
 117 Nyerere Rd., P.O. Box 70839
 Vingunguti 12109, Dar Es Salaam
 Phone: +255 222 861 793/794

Australia, New Zealand and Pacific Islands

Robert Bosch Australia Pty. Ltd.

Power Tools
 Locked Bag 66
 Clayton South VIC 3169
 Customer Contact Center
 Inside Australia:
 Phone: (01300) 307044
 Fax: (01300) 307045

Inside New Zealand:
 Phone: (0800) 543353
 Fax: (0800) 428570

Outside AU and NZ:
 Phone: +61 3 95415555
 www.bosch-pt.com.au
 www.bosch-pt.co.nz

**Republic of South Africa
Customer service**

Hotline: (011) 6519600

Gauteng – BSC Service Centre

35 Roper Street, New Centre
 Johannesburg
 Tel.: (011) 4939375
 Fax: (011) 4930126
 E-Mail: bsctools@icon.co.za

KZN – BSC Service Centre

Unit E, Almar Centre
 143 Crompton Street
 Pinetown
 Tel.: (031) 7012120
 Fax: (031) 7012446
 E-Mail: bsc.dur@za.bosch.com

Western Cape – BSC Service Centre

Democracy Way, Prosperity Park
 Milnerton
 Tel.: (021) 5512577
 Fax: (021) 5513223
 E-Mail: bsc@zsd.co.za

Bosch Headquarters

Midrand, Gauteng
 Tel.: (011) 6519600
 Fax: (011) 6519880
 E-Mail: rbsa-hq.pts@za.bosch.com

Armenia, Azerbaijan, Georgia

Robert Bosch Ltd.
 David Agmashenebeli ave. 61
 0102 Tbilisi, Georgia

Tel. +995322510073
www.bosch.com

Kyrgyzstan, Mongolia, Tajikistan, Turkmenistan, Uzbekistan

TOO "Robert Bosch" Power Tools, After Sales Service
Muratbaev Ave., 180
050012, Almaty, Kazakhstan
Service Email: service.pt.ka@bosch.com
Official Website: www.bosch.com, www.bosch-pt.com

Disposal

Measuring tools, accessories and packaging should be recycled in an environmentally friendly manner.



Do not dispose of measuring tools or batteries with household waste.

Only for AUS/NZ:

Supplier code ERAC000385

繁體中文

安全注意事項



為確保能夠安全地使用本測量工具，您必須完整詳讀本說明書並確實遵照其內容。若未依照現有之說明內容使用測量工具，測量工具內部所設置的防護措施可能無法發揮應有功效。謹慎對待測量工具上的警告標示，絕對不可讓它模糊不清而無法辨識。請妥善保存說明書，將測量工具轉交給他人時應一併附上本說明書。

- ▶ **小心** - 若是使用非此處指明的操作設備或校正設備，或是未遵照說明的操作方式，可能使您暴露於危險的雷射光照射環境之下。
- ▶ 本測量工具出貨時皆有附掛警示牌（請參見測量工具詳解圖中的標示）。
- ▶ 警示牌上的內容若不是以貴國語言書寫，則請於第一次使用前將隨附的當地語言說明貼紙貼覆於其上。



請勿將雷射光束對準人員或動物，您本人亦不可直視雷射光束或使雷射光束反射。因為這樣做可能會對他人眼睛產生眩光，進而引發意外事故或使眼睛受到傷害。

- ▶ 萬一雷射光不小心掃向眼睛，應立刻閉上眼睛並立刻將頭轉離光束範圍。
- ▶ 請勿對本雷射裝備進行任何改造。
- ▶ 請勿將雷射眼鏡當作護目鏡使用。雷射眼鏡是用來讓您看清楚雷射光束；但它對於雷射光照射並沒有保護作用。
- ▶ 請勿將雷射眼鏡當作護目鏡使用，或在道路上行進間使用。雷射眼鏡無法完全阻隔紫外線，而且還會降低您對於色差的感知能力。

- ▶ 本測量工具僅可交由合格的專業技師以原廠替換零件進行維修。如此才能夠確保本測量工具的安全性能。
- ▶ 不可放任兒童在無人監督之下使用本雷射測量工具。他們可能會不小心對他人眼睛產生眩光
- ▶ 請不要在存有易燃液體、氣體或粉塵等易爆環境下操作本測量工具。測量工具內部產生的火花會點燃粉塵或氣體。
- ▶ **小心！** 使用測量工具時若開啟 *Bluetooth®*（藍牙）功能，將可能對其他裝置或設備、飛機以及醫療器材（例如心律調節器、助聽器等）產生干擾。同樣亦無法完全排除對鄰近之人員或動物造成身體危害的可能性。請勿在醫療器材、加油站、化學設備、爆炸危險場所以及易爆環境等處附近，使用測量工具的 *Bluetooth®* 功能。請勿在飛機上使用測量工具的 *Bluetooth®* 功能。應避免直接貼靠在身體部位旁的長時間持續操作。

Bluetooth® 一詞及其標誌（商標）為 **Bluetooth SIG, Inc.** 所擁有之註冊商標。**Robert Bosch Power Tools GmbH** 對於此詞彙／標誌之任何使用均已取得授權。

產品和規格

請留意操作說明書中最前面的圖示。

依規定使用機器

該測量工具是用來測量距離、長度、高度、間距、傾角，並具有計算面積及體積之功能。

測量結果可透過 *Bluetooth®* 功能傳送至其他裝置。

本測量工具可同時適用於室內及戶外應用。

插圖上的機件

機件的編號和儀器詳解圖上的編號一致。

- (1) 螢幕
- (2) 測量按鈕 [▲]（可用於前方或側面）
- (3) 螢幕按鈕 [■]
- (4) 加號按鈕 [+]/選擇向右
- (5) 縮放按鈕
- (6) 腕帶繫座
- (7) 測量針頭解扣鈕
- (8) 測量針頭
- (9) 電源開關/刪除鈕 [⓪]
- (10) 標靶指示鈕
- (11) 減號按鈕 [-]/選擇向左
- (12) 螢幕按鈕 [■]
- (13) 功能按鈕 [Func]
- (14) 雷射警示牌
- (15) 序號
- (16) 電池盒蓋
- (17) 供三腳架使用的 1/4" 螺紋孔

- (18) 接收點
- (19) 雷射光束出口
- (20) 攝影鏡頭
- (21) 轉鎖
- (22) 電池
- (23) 保護套袋
- (24) 腕帶
- (25) 雷射標靶^{A)}
- (26) 雷射眼鏡^{A)}
- (27) 三腳架^{A)}

A) 圖表或說明上提到的配件，並不包含在基本的供貨範圍中。本公司的配件清單中有完整的配件供應項目。

指示器元件

- (a) 測量結果顯示列
- (b) 標靶指示 (十字交叉線)
- (c) 傾角指示器
- (d) 日期/時間
- (e) 測量基準點
- (f) 連線狀態
 -  Bluetooth® 功能未啟用
 -  Bluetooth® 功能已啟用，已成功連線
- (g) 電池電量指示器
- (h) 測量值顯示列
- (i) 設定 (螢幕按鈕)
- (j) 所選的測量功能
- (k) 內部記憶體 (螢幕按鈕)
- (l) 整合式輔助說明功能 (螢幕按鈕)
- (m) 返回 (螢幕按鈕)
- (n) 起始畫面 (螢幕按鈕)
- (o) 裝置設定

技術性數據

數位式雷射測距儀	GLM 150 C
產品機號	3601 K72 F..
測量範圍 (標準值)	0.08–150 m ^{A)}
測量範圍 (標準值，在不利條件下)	0.08–60 m ^{B)}
測量準確度 (標準值)	±1.5 mm ^{A)}
測量準確度 (標準值，在不利條件下)	±3.0 mm ^{B)}
最小顯示單位	0.5 mm
間接距離測量和水平面	
測量範圍	0°–360° (4x90°)
傾角測量	
測量範圍	0°–360° (4x90°)

數位式雷射測距儀	GLM 150 C
測量準確度 (標準值)	±0.2 ^{C)} D)E)
最小顯示單位	0.1°
一般資訊	
操作溫度	-10 °C ... +45 °C ^{F)}
儲藏溫度範圍	-20 °C ... +70 °C
容許的充電溫度範圍	+5 °C ... +40 °C
空氣相對濕度最大值	90 %
從基準點高度算起的最大可測量高度	2000 m
依照 IEC 61010-1，污染等級為	2 ^{G)}
雷射等級	2
雷射種類	650 nm, < 1 mW
雷射光束直徑 (當 25 °C 時) 約略值	
- 距離為 10 m	9 mm
- 距離為 100 m	90 mm
自動關機的執行時間點	
- 雷射	20 秒
- 測量工具 (未進行測量)	5 分鐘 ^{H)}
電池	3 x 1.5 V LR6 (AA)
重量符合 EPTA-Procedure 01:2014	0.23 kg
尺寸	142 (176) x 64 x 28 mm
防護等級	IP 54 (防塵防潑濺)
資料傳輸	
Bluetooth®	Bluetooth® (4.2 低功耗) ^{I)}
工作頻率範圍	2402 – 2480 MHz
最大發射功率	8 mW

A) 以測量工具前緣為測量起點、目標物反射率高 (例如白漆牆)、背景照明微弱、操作溫度為 25 °C。應額外再將誤差 ± 0.05 mm/m 列入計算。

B) 以測量工具前緣為測量起點，適用於高反射率目標物 (例如白漆牆)、背景照明亮度強。應額外再將誤差 ± 0.15 mm/m 列入計算。

C) 完成 0° 及 90° 校正。45° 以下必須另外加上每度最大 ±0.01° 的螺距誤差。此一測量準確度涉及三定向的傾角測量校正，請參閱圖 H

D) 在操作溫度 25 °C 下

E) 測量工具的左側為傾角測量的基準點。

F) 使用連續測量功能時的操作溫度最高為 +40 °C。

G) 只產生非傳導性污染，但應預期偶爾因水氣凝結而導致暫時性導電

H) 可調整自動關機時間 (2、5、10 分鐘或永不)。

I) 具有 Bluetooth® 低功耗功能之工具裝置，視其機型和作業系統，可能會有無法建立連線之情形。Bluetooth® 裝置必須支援 GATT 模式。

從產品銘牌的序號 (15) 即可確定您的測量工具機型。

安裝

裝入／更換拋棄式電池

建議使用鹼錳電池來驅動本測量工具。

- 按壓解扣鈕 (7)，然後將測量針頭 (8) 旋轉 180° 翻出。
- 若要打開電池盒蓋 (16)，請將轉鎖 (21) 往上翻，接著將它逆時針旋轉四分之一圈。從轉鎖處掀開電池盒蓋。裝入電池。此時請您注意是否有依照電池盒內側上的電極標示正確放入。
- ▶ 長時間不使用時，請將測量工具裡的電池取出。電池可能因長時間存放不使用而自行放電。
- ▶ 提示：裝入電池時才能使用 TrackMyTools 功能。

操作

操作機器

- ▶ 不可放任啟動的測量工具無人看管，使用完畢後請關閉測量工具電源。雷射可能會對旁人的眼睛產生眩光。
- ▶ 不可以讓濕氣滲入儀器中，也不可以讓陽光直接照射在儀器上。
- ▶ 勿讓測量工具暴露於極端溫度或溫度劇烈變化的環境。例如請勿將它長時間放在車內。測量工具歷經較大溫度起伏時，請先讓它回溫後再使用。如果儀器曝露在極端溫度下或溫差較大的環境中，會影響儀器的測量準確度。
- ▶ 測量工具須避免猛力碰撞或翻倒。測量工具遭受外力衝擊後，一律必須先檢查其精準度，確認後才能繼續使用 (參見「檢查距離測量的準確度」，頁 29)。
- ▶ 本測量工具配備無線介面。請您務必遵守不同場所的使用限制條件，例如在飛機或醫院內。

啟動／關閉

作業期間請注意：不可堵住或遮蓋到接收點 (18)、雷射光束出口 (19) 以及攝影鏡頭 (20)，否則將無法正確進行測量。

- 若要將測量工具開機並同時啟動雷射功能，請短按一下前面或側面的測量按鈕 (2) [▲]。
- 若要將測量工具開機但關閉雷射功能，請短按一下電源開關／刪除鈕 (9) [⊙]。
- ▶ 雷射光束不可以對準人或動物，操作人本身也不要直視光束，即使和光束相距甚遠也不可以做上述動作。

若要關閉雷射功能，請短按一下電源開關／刪除鈕 (9) [⊙]。

若要關閉攝影鏡頭，請按一下標靶指示鈕 (10)。

若要關閉測量工具，請按住電源開關／刪除鈕 (9) [⊙]。

即使測量工具已關機，記憶體中的測量值及裝置設定將繼續留存。

攝影鏡頭

測量工具初次開機時，將自動啟動攝影鏡頭 (20)。若要關閉，請按一下標靶指示鈕 (10)。

系統將於測量工具開機時儲存攝影鏡頭的 (開／關) 設定。

將雷射點調至最佳能見度

尤其是在空曠處、陽光照射環境下使用測量工具，或是在室內測量距離相隔較長時，您可能會看不到雷射點。除了打開攝影鏡頭以外，還可透過以下方式增強雷射點／測量目標位置的能見度：

- 設定螢幕亮度 (裝置設定)
- 使用按鈕 (5) 進行縮放。

測量流程

測量工具開機後的模式為長度測量功能。如欲使用其他測量功能，按一下按鈕 (13) [Func]。利用按鈕 (4) [+] 或按鈕 (11) [-] 選擇所需測量功能。若要啟用該測量功能，請按一下按鈕 (13) [Func] 或測量按鈕 (2) [▲]。

啟動後，測量工具後緣即被選取做為測量基準點。若要切換基準點 (參見「選擇基準點 (請參考圖 A)」，頁 24)。將測量工具置於所需的測量起點上 (例如：牆壁)。

提示：利用電源開關／刪除鈕 (9) [⊙] 開啟測距儀後，按一下測量按鈕 (2) [▲] 即可啟動雷射功能。短按一下測量按鈕 (2) [▲] 即可開始測量。隨後，雷射光束即自動關閉。若要進行另一次測量，請重複此程序。

測距儀設為雷射光束常亮並使用連續測量功能時，只需在測量按鈕 (2) [▲]。

- ▶ 雷射光束不可以對準人或動物，操作人本身也不要直視光束，即使和光束相距甚遠也不可以做上述動作。

提示：原則上 0.5 秒鐘內就會出現測量值，最遲為 4 秒鐘左右。測量時間取決於距離、光線情況和目標物表面的反射特性。結束測量後，雷射光束會自動關閉。結束測量後，常亮狀態下的雷射光束並不會關閉。

選擇基準點 (請參考圖 A)

共有四個不同的測量基準點供您選擇：

- 測量工具後緣 (例如貼靠在牆面上時)、
- 旋轉 180° 後翻出的測量針頭 (8) (例如：從角落測量)、
- 測量工具前緣 (例如：以桌緣做為測量起點)、
- 螺紋孔中心點 (17) (例如：使用三腳架進行測量)

系統會自動偵測測量針頭 (8) 是旋轉 180° 翻出或為收回狀態，並建議相關基準點。按一下測量按鈕 (2) [▲] 以確認您的設定。

利用螢幕按鈕 (3) [■] 選取測量工具的設定選項。利用按鈕 (4) [+] 或按鈕 (11) [-] 選擇基準點，然後再按一下按鈕 (13) [Func] 以確認您的設定。

測量工具每次啟動之後自動以測量工具後緣為預設基準點。

雷射光束常亮

您可以按需求將測量工具改設為雷射光束常亮。此時需利用螢幕按鈕 (3) [■] 選取測量工具的設定選項。利用按鈕 (4) [+] 或按鈕 (11) [-] 選擇雷射光束常亮，再按一下按鈕 (13) [Func] 以確認您的設定。

▶ 雷射光束不可以對準人或動物，操作人本身也不要直視光束，即使和光束相距甚遠也不可以做上述動作。

若是選用此項設定，則在兩次測量的間隔時間裡雷射光束也會保持開啟，您只需短按一次測量按鈕 (2) [▲] 即可進行測量。

若需關閉「雷射光束常亮」，請回到該項設定，或者關閉測量工具電源時此項功能也會自動關閉。

「設定」功能表

若要進入「設定」功能表 (i)，請短按一下螢幕按鈕 (3) [■] 或按住按鈕 (13) [Func] 不放。

利用按鈕 (4) [+] 或按鈕 (11) [-] 選擇所需設定，然後再按一下按鈕 (13) [Func] 以確認您的設定。請您選擇所需設定。

若要離開「設定」功能表，請按一下電源開關/刪除鈕 (9) [○] 或螢幕按鈕 (12) [■]。

設定

	Bluetooth®
	基準點
	定時功能
	雷射光束常亮
	校正傾角測量
	校正標靶指示
	裝置設定

定時功能

例如當您在難以觸及的位置上進行測量時或想避免測量工具在測量期間晃動，此一定時功能就可發揮很大的功效。

請到設定中選取此定時功能。請選取觸發測量前的所需時間間隔，然後按一下測量按鈕 (2) [▲] 或按鈕 (13) [Func] 以確認您的設定。

接著再按一下測量按鈕 (2) [▲]，以便啟動雷射光束並確認計時時間。再按一下測量按鈕 (2) [▲]，以便觸開測量程序。將於所選的時間間隔之後，開始進行測量。測量值將出現在測量結果顯示列 (a)。

觸發至真正開始執行測量之間的這段時間，狀態列中的上方將顯示時間間隔。

設定了定時功能之後，便無法進行連續測量以及最小值測量/最大值測量。

關閉測量工具電源或到設定功能表裡關閉定時器之前，定時器將保有原來的設定。

「裝置設定」功能表

請到「設定」功能表中，選取「裝置設定」功能表。

利用按鈕 (4) [+] 或按鈕 (11) [-] 選擇所需的裝置設定，然後再按一下按鈕 (13) [Func] 以確認您的設定。請您選擇所需的裝置設定。

若要離開「裝置設定」功能表 (o)，請按一下電源開關/刪除鈕 (9) [○] 或螢幕按鈕 (12) [■]。

裝置設定

	語言
	時間與日期
ft/m	尺寸單位
	角度單位
	TrackMyTools
	裝置資訊
	聲音訊號
	關機時間
	調暗
	螢幕亮度
	螢幕方位

設定語言

請到裝置設定中選取「語言」。設定所需語言，然後按一下按鈕 (13) [Func] 或測量按鈕 (2) [▲] 以確認您的設定。

設定時間與日期

請到裝置設定中選取「時間與日期」。請依照螢幕上的指示設定時間與日期，並按一下螢幕按鈕 (12) [■] 以確認您的設定。

提示：更換電池後必須重新設定時間與日期。

切換尺寸單位

請到裝置設定中選取「尺寸單位」。基本設定中的尺寸單位為「m」（公尺）。

設定所需尺寸單位，然後按一下按鈕 (13) [Func] 以確認您的設定。

若要離開此功能表項目，請按一下電源開關/刪除鈕 (9) [○] 或螢幕按鈕 (3) [■]。測量工具關機後，所選之裝置設定仍將保留。

切換角度單位

請到裝置設定中選取「角度單位」。基本設定中的角度單位是「°」（度）。

設定所需角度單位，然後按一下按鈕 (13) [Func] 以確認您的設定。

若要離開此功能表項目，請按一下電源開關/刪除鈕 (9) [○] 或螢幕按鈕 (3) [■]。測量工具關機後，所選之裝置設定仍將保留。

TrackMyTools

請到裝置設定中選取「TrackMyTools」。按一下按鈕 (13) [Func] 以確認您的設定。

必須進行初次啟用。僅能透過相關 App 或相關電腦程式進行資料傳輸。

TrackMyTools 可隨時重新停用。

測量工具關機時，系統將儲存 TrackMyTools 的 (啟用/停用) 設定。

提示：裝入電池時才能使用 TrackMyTools 功能。電池更換後必須短暫開啟測量工具電源，以便啟用 TrackMyTools。

螢幕照明

請到裝置設定中選取「調暗」。

螢幕照明的設定為持續亮起。若未操作按鈕，螢幕照明會在約 30 秒鐘後變暗，以維護充電電池壽命。調暗之前的靜候時間可進行調整 (裝置設定)。

螢幕可配合環境條件調成不同的亮度等級 (裝置設定)。

測量功能

提示：整合式輔助說明功能

測量工具裡針對每一個測量功能都存有一份動畫說明。若要執行動畫說明，請選取按鈕 (13) [Func]、按鈕 (4) [+] 或 (11) [-] 接著再按鈕螢幕按鈕 (3) [■]。動畫將告訴您所選測量功能的詳細操作方式。

您可利用 (3) [■] 隨時暫停/重新播放動畫。也可利用按鈕 (4) [+] 或 (11) [-] 快轉或倒退。

長度測量

請選擇長度測量 。

若要啟動雷射光束，請短按一下測量按鈕 (2) [▲]。按一下測量按鈕 (2) [▲] 即可開始測量。測量結果會出現在螢幕下方。

每一次想要重新進行測量時，請重複上述步驟。最新測量值將出現在螢幕下方，而前一次的測量值則位於其上，依此類推。

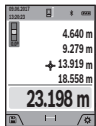

連續測量

進行連續測量時，可針對目標物讓測量工具進行相對移動，期間系統將每 0.5 秒左右更新一次測量值。舉例來說，您可從某一個牆面離開，走到相隔所需距離的位置，期間可隨時看到當下的實際距離。

請選擇連續測量 。

若要啟動雷射光束，請短按一下測量按鈕 (2) [▲]。移動儀器，直至所需距離出現在螢幕下方為止。

再按一下測量按鈕 (2) [▲] 即可中斷連續測量功能。目前的測量值將顯示於螢幕下方。而最大及最小測量值則是位於其上。若是再按一次測量按鈕 (2) [▲]，則連續測量將重頭開始。

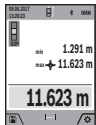

連續測量功能將於 5 分鐘後自動關閉。

面積測量

請選擇面積測量 。

接著按照進行長度測量之方式，測量寬度、長度即可。進行這兩次測量之間，雷射光束將保持開啟。面積測量指示器  中，即將進行測量的長度以閃爍方式顯示 (請參考指示器元件 (j))。

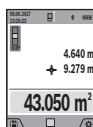

第一個測量值顯示於螢幕上方。

完成第二次測量後，將自動計算出面積並於畫面中顯示該值。最後的計算結果位於螢幕下方，而個別測量值則位於其上方。

體積測量

請選擇體積測量 。

接著按照進行長度測量之方式，測量寬度、長度及深度即可。進行這三次測量之間，雷射光束將保持開啟。體積測量指示器  中，即將進行測量的長度以閃爍方式顯示 (請參考指示器元件 (j))。

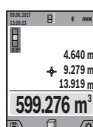

第一個測量值顯示於螢幕上方。

完成第三次測量後，測距儀將自動算出體積並於畫面中顯示該值。最後的計算結果位於螢幕下方，而個別測量值則位於其上方。

間接長度測量

請選擇間接距離測量 。間接距離測量共分為四種測量功能供您選用，它們可分別用來測量不同類型的距離。

無法進行直接測量時 (例如有障礙物會阻擋雷射，或者沒有目標物可充當反射體時)，則必須以間接的方式測量。此一測量方式僅適用於垂直方向。任何水平方向的偏差都會導致測量誤差。

提示：間接距離測量的精準度永遠不如直接距離測量。視運用方式而定，其測量誤差可能大於直接距離測量。為改善測量準確度，建議您使用三腳架 (配件)。雷射將在各次單一測量之間的空檔保持開啟

a) 間接高度測量 (請參考圖 B)

請選擇間接高度測量 。

請注意：測量工具應位於與下方測量點一致的高度上。接著將測量工具沿基準點側傾，依照進行長度測量之方式來測量「1」線段 (即螢幕上以紅線顯示者)。

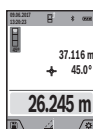

完成測量後，測量結果顯示列 (a) 中顯示的測量結果即為您想要確認的「X」線段。「1」線段及「α」角的測量值則是位於測量值顯示列 (h) 中。

b) 雙重間接高度測量 (請參考圖 C)

本測量工具可以間接測量位於測量工具垂直平面上的任何長度。請選擇雙重間接高度測量 。依照進行長度測量之方式依序測量線段「1」和「2」。

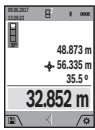

完成測量後，測量結果顯示列 (a) 中顯示的測量結果即為您想要確認的「X」線段。「1」線段、「2」線段及「α」角的測量值則是位於測量值顯示列 (h) 中。

請注意：在同一個測量流程中進行每一次測量時，測量基準點（例如：測量工具後緣）都必須精準地保持在同一位置上。

c) 間接長度測量 (請參考圖 D)

請選擇間接長度測量

請注意：測量工具必須與您想要確認的測量點位在同一高度上。接著將測量工具沿基準點側傾，依照進行長度測量之方式來測量「1」線段。

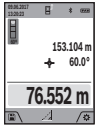

完成測量後，測量結果顯示列 (a) 中顯示的測量結果即為您想要確認的「X」線段。「1」線段及「α」角的測量值則是位於測量值顯示列 (h) 中。

d) 梯形測量 (請參考圖 E)

舉例來說，梯形測量可以用來量測斜面屋頂的長度。

請選擇梯形測量

依照進行長度測量之方式依序測量線段「1」、「2」和「3」。請注意：線段「3」的測量起點正是線段「1」的終點，線段「1」與「2」之間以及「1」與「3」之間應呈垂直。

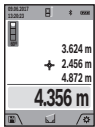

完成最後一個測量後，測量結果顯示列 (a) 中顯示的測量結果即為您想要確認的「X」線段。測量值顯示列 (h) 中將詳列出每一個測量值。

牆壁面積測量 (請參考圖 F)

牆壁面積測量是用來計算相同高度之數個單一牆面的總面積。插圖範例中所測量的是：空間高度 H 相同但長度不同 L 之多個牆面加總起來的總面積。

請選擇牆面測量

依照進行長度測量之方式來測量空間高度 H。測量值將顯示於上方測量值列。雷射功能將保持開啟。

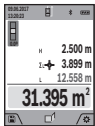

隨後請測量第一面牆的長度 L_1 。將自動計算出面積並於測量結果顯示列 (a) 中顯示該值。最新得出的長度測量值位於下方測量值列 (h)。雷射功能將保持開啟。

現在請您測量第二面牆的長度 L_2 。測量值列 (h) 中所顯示的單次測量值將累加於長度 L_1 中。兩個長度（顯示於中間測量值列 (h)）加總後再乘以前儲存的高度 H。所得的總面積值將顯示於測量結果顯示列 (a) 中。

您可以繼續測量任意多個長度 L_x ，系統會自動相加這些值後再乘以高度 H。為求正確計算面積，其前提是：所有區塊面積的第一個測量長度要一致（在本範例中即為空間高度 H）。

放樣功能 (請參考圖 G)

放樣功能可重複測量一個自訂長度（距離）。您可將此長度移植到任一表面上，以便將材料切成相同

長度或建構石膏隔間牆等等。可設定的最小長度為 0.1 m，可設定的最大長度為 50 m。

提示：使用放樣功能時，所顯示的是到螢幕中標記處的距離。基準點不是測量工具的邊緣。

請選擇放樣功能

請利用按鈕 (4) [+] 或按鈕 (11) [-] 設定所需長度。

按一下測量按鈕 (2) [▲] 即可啟動放樣功能，接下來請您慢慢從起點往前走。



測量工具將持續測量目前與起點之間的間距。此時將同時顯示您的自訂長度以及目前測量值。向下或向上箭頭表示：到下一個或最後一個記號的最短距離。

提示：持續測量時，只要按下測量按鈕 (2) [▲] 並按住不放，亦可將目前測得的數值設為自訂長度。



位於左邊的系數代表目前可換算成幾個完整自訂長度。螢幕兩旁的綠色箭頭則是告知還有多長距離就應標設下一個記號。

當參照值不在螢幕範圍上，則紅色箭頭所指位置或紅色字樣代表實際值。

傾角測量 / 數位水平儀

請選擇傾角測量 / 數位水平儀

測量工具將於這兩種顯示之間自動切換。

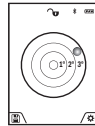

數位水平儀是用來檢查某一物體的水平和垂直定位（例如洗衣機、冰箱等等）。

傾斜度若超過 3°，螢幕上的圓球將以紅色顯示。

數位水平儀的基準點為測量工具底部。

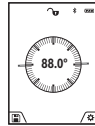

傾角測量則是用來測量坡度或傾斜度（例如用於樓梯、欄杆、家具榫接、管路鋪設等等）。

測量工具的左側為傾角測量的基準點。測量中途如果此符號開始閃爍，代表測量工具過度側傾。

儲存功能

每次完成測量後，將自動儲存測量值或最後的計算結果。

儲存值顯示

最多可叫出 50 個數值（測量值或內含測量值的相片）。

請按一下螢幕按鈕 (12) [■] 以選擇儲存功能。

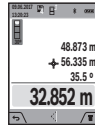

螢幕上方所顯示的是所儲存之數值的編號，下方是所屬之儲存值與測量功能

請按一下按鈕 (4) [+]，即可往前翻頁至其他儲存值。

請按一下按鈕 (11) [-]，即可往後翻頁至其他儲存值。

如果記憶體中沒有數值，螢幕下方將出現「0.000」而上方則是出現「0」。

最舊數值位於記憶體中的第 1 筆資料；最新數值則是位於第 50 筆資料（儲存值達 50 筆時）。如果選

要儲存其他筆數值資料，則將一律刪除記憶體中的最舊數值。

刪除記憶值

若要開啟儲存內容，請按一下螢幕按鈕 (12) [■]。視需要重複按下螢幕按鈕 (3) [■] 即可反序刪除測量值。若要刪除所有儲存內容，請同時按下螢幕按鈕 (3) [■] 和縮放按鈕 (5)。

數值相加／相減

測量值或最後的計算結果可進行加減。

數值相加

以下範例將說明如何累加面積：請依照「面積測量」小節進行面積測量(參見「面積測量」，頁 26)。



請按一下按鈕 (4) [+]. 隨即出現計算後得出的面積並加註「+」符號。按一下測量按鈕 (2) [▲], 即可開始其他面積測量。請依照「面積測量」小節進行面積測量(參見「面積測量」，頁 26)。第二次測量完成後，螢幕下方會立即顯示第二次面積測量的結果。若要顯示最後的計算結果，請再按一下測量按鈕 (2) [▲]。

提示：進行長度測量時，將立即顯示最後的計算結果。

數值相減

若要將數值相減，請按一下按鈕 (11)[-]. 後續步驟請比照「數值相加」。

刪除測量值

在所有測量功能中，只要按一下電源開關／刪除鈕 (9) [⊙], 即可刪除您所測得的最後一項測量值。

Bluetooth® 介面

將資料傳輸至其他裝置

本測量工具配備 Bluetooth® 模組，透過此一無線技術即可與具有 Bluetooth® 介面的特定行動終端裝置進行資料傳輸（例如智慧型手機、平板電腦）。

如需 藍牙® 連線的最低系統需求相關資訊，請至博世網站：www.bosch-pt.com。

► 如需其他資訊，請參考博世產品說明頁。

透過 Bluetooth® 進行資料傳輸時，行動終端裝置與測量工具之間可能會有時間遲滯的現象。問題可能是出在兩個裝置的距離或是出在測量目標物本身。

啟用行動終端裝置的 Bluetooth® 介面，以便進行資料傳輸

請至設定中啟用 Bluetooth® 介面。請按一下按鈕 (4) [+], 即可啟用 Bluetooth® 訊號。請確認：行動終端裝置上的 Bluetooth® 介面已啟用。

為了擴充行動終端裝置的功能並簡化資料處理，本公司另外開發了專用的博世應用程式 (App)

「Measuring Master」供您選用。您可到相關商店按照所使用的終端裝置下載該程式。

博世應用程式啟動之後，將自動為您進行行動終端裝置與測量工具之間建立連線。萬一同時找到多個啟用的測量工具，請您根據序號選擇相符的那一個測量工具。序號 (15) 位於測量工具的產品銘牌上。連線狀態以及啟用之連線 (f) 將顯示於測量工具的螢幕 (1) 中。

停用 Bluetooth® 介面

請至設定中停用 Bluetooth® 連線。若要停用

Bluetooth® 訊號，請按一下按鈕 (11) [-] 或關閉測量工具電源。

作業注意事項

- 如需其他資訊，請參考博世產品說明頁。
- 本測量工具配備無線介面。請您務必遵守不同場所的使用限制條件，例如在飛機或醫院內。

一般注意事項

測量時，接收點 (18)、雷射光束出口 (19) 以及攝影鏡頭 (20) 不得有遮蓋物。

進行測量期間不得移動測量工具。因此，請將測量工具儘可能放置在固定的擋塊或托架平面上。

影響測量範圍的因素

測量範圍取決於光線情況和目標物表面的反射特性。有強烈外來燈光影響時，使用內建攝影鏡頭 (20)、雷射眼鏡 (26) (配件) 和雷射標靶 (25) (配件) 可提高雷射光束的能見度，或遮掉目標物表面的光線。

影響測量結果的因素

由於物理作用之故，無法排除在不同類型表面上進行測量時出現誤差的狀況。表面的類型可分為：

- 透明表面（例如玻璃、水）
- 反射表面（例如拋光金屬、玻璃）
- 多孔狀表面（例如具有阻隔特性的材料）
- 結構性表面（例如毛胚、天然石材）。

必要時請將雷射標靶 (25) (配件) 放到表面上。

如果未正確地瞄準好目標物表面，也可能會出現測量誤差。

此外有溫差的空氣層和間接反射都可能影響測量值。

檢查傾角測量準確度及進行相關校正（請參考圖 H）

請定期檢查傾角測量準確度。其做法是執行一次反轉測量。請將測量工具放到桌上，然後進行傾角測量。將測量工具旋轉 180°，然後再測量一次傾角。顯示值最多可相差 0.3°。

如果差距超出規定則必須重新校正測量工具。若要這麼做，請至設定中選擇 。並遵照螢幕上的指示。

本測試工具經歷溫度劇烈變化或碰撞之後，建議您進行準確度測試，並視需要執行校正。本測試工具經歷溫度劇烈變化或碰撞之後，必須先回溫一段時間然後才進行校正。

檢查距離測量的準確度

您可按以下方式檢查測量工具的準確度：

- 選擇一個您本人非常熟悉且長度不會改變的測量線段，線段長度大概在 3 到 10 公尺之間（例如房間的寬度，門口等）。該測量應在有利條件下進行，亦即該測量長度位於室內、背景燈光微弱、測量目標物的表面光滑且具有良好反射性（例如白漆牆）。
 - 連續測量該長度 10 次。
- 在有利的測量條件下，各次的測量結果與平均值的不得相差超過 ± 2 mm。請做好測量記錄，以便日後充當檢查儀器準確度的根據。

標靶指示的準確度及校正（十字交叉線）

請定期檢查雷射與標靶指示的定位準確度。

- 請選擇淺色但照明儘可能微弱的表面（例如白牆）做為測量目標，並相距至少 5 m。
- 請確認雷射點是否位於螢幕上的標靶指示內。

如果雷射點並沒有在標靶指示之內，則必須重新校正標靶指示。

若要這麼做，請至設定中選擇  CAL。並遵照螢幕上的指示。

距離較長時（大於五公尺）還會出現標靶記號，為您標示測量點位置。

使用三腳架（配件）進行測量

當測量目標位於遠處時，必須使用三腳架。請利用 1/4" 螺紋孔 (17) 將測量工具安裝到三腳架 (27) 或一般市售相機三腳架的快拆座上。或者您也可以使用一般市面上的照相機三腳架。

請至設定中，選好使用三腳架時的測量基準點（三腳架基準點）。

故障 - 原因和補救方法

原因	補救措施
溫度警示燈閃爍時，無法進行測量	
測量工具已超出 -10°C 至 $+45^{\circ}\text{C}$ 的操作溫度之範圍（使用連續測量功能時須在 $+40^{\circ}\text{C}$ 以下）。	停下工作靜待測量工具的溫度回到操作溫度範圍。
螢幕上出現「Error」	
相加／相減不同尺寸單位的測量值	只能相加／相減相同尺寸單位的測量值。
雷射與目標物之間的夾角太小。	請拉大雷射與目標物之間的夾角。
目標物表面的反射性太強（例如鏡子）或太弱（例如白漆牆）。	請使用雷射標靶 (25) (配件)
原因	補救措施
如黑色材料），或是環境光線過強。	
雷射光束出口 (19)、接收點 (18) 或攝影鏡頭 (20) 起霧（例如因溫度變化過快）。	請用軟布擦乾雷射光束出口 (19)、接收點 (18) 或攝影鏡頭 (20)
計算出來的數值大於 1 999 999 或小於 $-999\,999\text{ m}^2/\text{m}^3$ 。	進行測量時把待計算的長度再細分成多段。
螢幕上出現「CAL」和「ERROR」	
未按照正確順序或未在正確位置進行傾角測量校正作業。	根據螢幕和使用說明書上的指示再做一次校正。
進行校正時使用的平面並非準確位於水平位置或垂直位置。	在水平平面或垂直平面上再做一次校正。必要時可先用水平儀檢查該平面。
按下按鈕時移動了或翻倒了測量工具。	再做一次校正，按，按壓按鈕時不要觸動測量工具。
測量結果不可靠	
目標物表面的反射影像有變（例如水、玻璃）。	目標物表面被遮蓋住。
雷射光束出口 (19) 或接收點 (18) 或攝影鏡頭 (20) 被擋住。	不要有任何物品遮蔽雷射光束出口 (19)、接收點 (18) 或攝影鏡頭 (20)。
設定了錯誤的基準點。	選擇適合測量功能的基準點。
有障礙物擋住雷射光束的線條。	投射在目標物表面上的雷射點必須完整。
無法啟用 Bluetooth® 功能	
電池電力不足。	更換電池
沒有 Bluetooth® 連線	
Bluetooth® 連線被干擾	請關掉然後再重新開啟測量工具上及行動終端裝置上的 Bluetooth® 功能。
	請檢查行動終端裝置上的應用程式。
	請確認測量工具和行動終端裝置上的 Bluetooth® 功能已啟用。
	請檢查您的行動終端裝置是否已過載。
	請縮短本測量工具與行動終端裝置之間的距離。
	請排除本測量工具與行動終端裝置之間的障礙物（例如鋼筋混凝土、金屬門扇）。請遠離電磁干擾源（例如無線區域網路發射器）。



測量工具會在每次進行測量時監控功能是否正常。若確認出現故障，螢幕上僅會顯示左側符號。在這種情況下，或上述補救措施無法排除故障情形時，請透過您的經銷商將該測量工具轉交給博世維修中心或各區維修站。

維修和服務

保養與清潔

測量儀器必須隨時保持清潔。

不可以把儀器放入水或其它的液體中。

使用柔軟濕布擦除儀器上的污垢。切勿使用清潔劑或溶液。

尤其是在清潔接收點 (18)、雷射出口處 (19) 以及攝影鏡頭 (20) 時必須格外小心：請注意，接收點、雷射出口處或攝影鏡頭不得有任何髒污。接收點、雷射出口處和攝影鏡頭等位置，僅可使用攝影鏡頭專用清潔工具來進行清潔。請勿試圖用尖銳物品去除接收點、雷射出口處或攝影鏡頭上的髒污，亦不可直接擦拭（可能造成細微刮痕）。

如需送修，請將測量工具放入保護套袋 (23) 內後，再轉交給相關單位。

顧客服務處和顧客諮詢中心

本公司顧客服務處負責回答有關本公司產品的維修、維護和備用零件的問題。以下的網頁中有分解圖和備用零件相關資料：www.bosch-pt.com 如果對本公司產品及其配件有任何疑问，博世應用諮詢小組很樂意為您提供協助。

當您需要諮詢或訂購備用零件時，請務必提供本產品型號銘牌上 10 位數的產品機號。

中國香港和澳門特別行政區

羅伯特·博世有限公司
香港北角英皇道625號21樓
客戶服務熱線：+852 2101 0235
傳真：+852 2590 9762
電子郵件：info@hk.bosch.com
www.bosch-pt.com.hk

台灣

台灣羅伯特博世股份有限公司
建國北路一段90號6樓
台北市10491
電話：(02) 7734 2588
傳真：(02) 2516 1176
www.bosch-pt.com.tw

製造商地址：

Robert Bosch Power Tools GmbH
羅伯特·博世電動工具有限公司
70538 Stuttgart / GERMANY
70538 斯圖加特/德國

廢棄物處理

必須以符合環保要求的方式回收再利用損壞的儀器、配件和包裝材料。



不得將測量工具與電池當成一般垃圾丟棄！

한국어

안전 수칙



측정공구의 안전한 사용을 위해 모든 수칙들을 숙지하고 이에 유의하여 작업하시기 바랍니다. 측정공구를 해당 지침에 따라 사용하지 않으면, 측정공구에 내장되어 있는 안전장치에 안 좋은 영향을 미칠 수 있습니다. 측정공구의 경고판을 절대로 가려서는 안 됩니다. 안전 수칙을 잘 보관하고 공구 양도 시 측정공구와 함께 전달하십시오.

- ▶ 주의 - 여기에 제시된 조작 장치 또는 조정 장치 외의 용도로 사용하거나 다른 방식으로 작업을 진행하는 경우, 광선으로 인해 폭발될 위험이 있습니다.
- ▶ 본 측정공구는 경고판과 함께 공급됩니다(측정공구 도면에 표시되어 있음).
- ▶ 처음 사용하기 전에 함께 공급되는 한국어로 된 스티커를 독문 경고판 위에 붙이십시오.



사람이나 동물에게 레이저 광선을 비추거나, 광선을 직접 또는 반사시켜 보지 마십시오. 이로 인해 눈이 부시게 만들어 사고를 유발하거나 눈에 손상을 입을 수 있습니다.

- ▶ 눈으로 레이저 광선을 쳐다본 경우, 의식적으로 눈을 감고 곧바로 고개를 돌려 광선을 피하십시오.
- ▶ 레이저 장치를 개조하지 마십시오.
- ▶ 레이저 보안경을 일반 보안경으로 사용하지 마십시오. 레이저 보안경은 레이저 광선을 보다 잘 감지하지만, 그렇다고 해서 레이저 광선으로부터 보호해주는 것은 아닙니다.
- ▶ 레이저 보안경을 선글라스 용도 또는 도로에서 사용하지 마십시오. 레이저 보안경은 자외선을 완벽하게 차단하지 못하며, 색상 분별력을 떨어뜨립니다.
- ▶ 측정공구의 수리는 해당 자격을 갖춘 전문 인력에게 맡기고, 수리 정비 시 순정 부품만 사용하십시오. 이 경우에만 측정공구의 안전성을 오래 유지할 수 있습니다.
- ▶ 어린이가 무감독 상태로 레이저 측정공구를 사용하는 일이 없도록 하십시오. 의도치 않게 사람의 눈이 부시게 할 수 있습니다.
- ▶ 가연성 유체나 가스 혹은 분진 등 폭발 위험이 있는 곳에서 측정공구를 사용하지 마십시오. 측정공구에 분진이나 증기를 접화하는 스파크가 생길 수 있습니다.
- ▶ 주의! 측정공구의 Bluetooth® 사용은 다른 기기나 설비, 비행기 및 의료기기(예: 심박 조절기,보

청기) 등에 장애를 가져올 수 있습니다. 마찬가지로 근처에 있는 동물이나 사람에게도 좋지 않은 영향을 미칠 수 있습니다. 측정공구의 Bluetooth® 사용은 의료 기기, 주유소, 화학설비 및 폭발 위험이 있는 주변에서는 삼가하십시오. 비행기에서 측정공구의 Bluetooth® 사용은 삼가하십시오. 오랜 시간 신체에 직접 접촉하여 작동하는 것을 삼가하십시오.

Bluetooth® 글자와 그림(로고)은 Bluetooth SIG, Inc.의 등록상표입니다. Robert Bosch Power Tools GmbH는 허가를 받아 이를 사용하고 있습니다.

제품 및 성능 설명

사용 설명서 앞 부분에 제시된 그림을 확인하십시오.

규정에 따른 사용

본 측정공구는 거리, 길이, 높이, 간격, 경사도를 측정하고 면적 및 체적을 계산하는 데 사용됩니다. 측정 결과는 Bluetooth®를 통해 다른 장치로 전송할 수 있습니다. 측정공구는 실내 및 실외에서 모두 사용할 수 있습니다.

제품의 주요 명칭

제품의 주요 명칭에 표기되어 있는 번호는 측정공구의 그림이 나와있는 면을 참고하십시오.

- (1) 디스플레이
- (2) 측정 버튼 [▲] (앞쪽 또는 측면에서 사용 가능)
- (3) 소프트 버튼 [■]
- (4) 플러스 버튼 [+]/우측으로 이동 선택
- (5) 줌 버튼
- (6) 운반 고리 삽입부
- (7) 측정 핀 작동 버튼
- (8) 측정 핀
- (9) 전원-삭제 버튼 [⊘]
- (10) 뷰파인더 버튼
- (11) 마이너스 버튼 [-]/좌측으로 이동 선택
- (12) 소프트 버튼 [■]
- (13) 기능 버튼 [Func]
- (14) 레이저 경고판
- (15) 일련 번호
- (16) 배터리 케이스 덮개
- (17) 1/4" 삼각대 소켓
- (18) 수신 렌즈
- (19) 레이저빔 발사구
- (20) 카메라
- (21) 스크류 캡
- (22) 배터리

- (23) 안전 케이스
- (24) 운반 고리
- (25) 레이저 표적판^{A)}
- (26) 레이저 보안경^{A)}
- (27) 삼각대^{A)}

A) 도면이나 설명서에 나와있는 액세서리는 표준 공급부품에 속하지 않습니다. 전체 액세서리는 저희 액세서리 프로그램을 참고하십시오.

디스플레이 내용

- (a) 결과 표시열
- (b) 뷰파인더(십자선)
- (c) 경사각도 표시
- (d) 날짜/시간
- (e) 측정 기준 레벨
- (f) 연결 상태



Bluetooth® 활성화되지 않음



Bluetooth® 작동, 연결됨

- (g) 배터리 충전상태 표시기
- (h) 측정치 표시열
- (i) 설정 (소프트 버튼)
- (j) 선택된 측정 기능
- (k) 내부 메모리 (소프트 버튼)
- (l) 도움말 기능 (소프트 버튼)
- (m) 뒤로 (소프트 버튼)
- (n) 시작 화면 (소프트 버튼)
- (o) 장치 설정

제품 사양

디지털 레이저 거리 측정기	GLM 150 C
제품 번호	3 601 K72 F..
측정 영역(표준)	0.08-150 m ^{A)}
측정 영역(표준, 부적절한 조건)	0.08-60 m ^{B)}
측정 정확도(표준)	±1.5 mm ^{A)}
측정 정확도(표준, 부적절한 조건)	±3.0 mm ^{B)}
최소 표시 단위	0.5 mm
간접 거리 측정 및 수준기	
측정 영역	0°-360° (4x90°)
경사 측정	
측정 영역	0°-360° (4x90°)
측정 정확도(표준)	±0.2 ^{C)D)E)}
최소 표시 단위	0,1°
일반 사항	
작동 온도	-10 °C...+45 °C ^{F)}
보관 온도	-20 °C...+70 °C

디지털 레이저 거리 측정기		GLM 150 C
허용 충전 온도 범위		+5 °C... +40 °C
상대 습도 최대		90 %
기준 높이를 초과한 최대 사용 높이		2,000 m
IEC 61010-1에 따른 오염도		2 ^{CI}
레이저 등급		2
레이저 유형		650 nm, <1 mW
레이저빔 직경(25 °C일 때) 약		
- 10 m 떨어진 거리		9 mm
- 100 m 떨어진 거리		90 mm
자동 꺼짐 기능이 활성화되는 시간, 약		
- 레이저		20 초 후
- 측정공구(측정 미포함)		5 분 ^{H)}
배터리		3 × 1.5 VLR6 (AA)
EPTA-Procedure 01:2014에 따른 중량		0.23 kg
치수		142 (176) x 64 x 28 mm
보호 등급		IP 54 (먼지 및 분무수 침투 방지)

데이터 전송	
Bluetooth®	Bluetooth® (4.2 Low Energy) ^{I)}
작동 주파수 대역	2402 - 2480 MHz
최대 송신 출력	8 mW

- A) 측정공구의 앞 모서리부터 측정할 경우, 표적물(예: 흰색으로 칠한 벽)의 반사율을 높게, 배경 조명을 약하게 조정해야 합니다. 작동 온도는 25 °C입니다. 그 외에도 ± 0.05 mm/m 정도 차이가 있을 수 있음을 고려해야 합니다.
- B) 측정공구의 앞 모서리부터 측정할 경우, 표적물(예: 흰색으로 칠한 벽)의 반사율을 높게, 배경 조명을 강하게 조정해야 합니다. 그 외에도 ± 0.15 mm/m 정도 차이가 있을 수 있음을 고려해야 합니다.
- C) 0° 및 90°에서 보정 후, 최대 ±0.01°/도 ~ 45°의 추가 경사 오류. 측정 정밀도는 경사 측정 보정의 세 가지 방향에 해당됩니다(그림 H 참조).
- D) 작동 온도 25 °C
- E) 측정공구의 좌측은 경사 측정을 위한 기준점 역할을 합니다.
- F) 연속 측정 기능의 경우 최고 작동 온도는 +40 °C입니다.
- G) 비전도성 오염의 경우만, 가끔씩 일시적으로 이슬로 인해 전도성이 유발될 수 있음
- H) 자동 꺼짐 시간은 설정할 수 있습니다(2분, 5분, 10분 또는 꺼짐 설정하지 않음).
- I) Bluetooth® 저 에너지 기기의 경우, 모델과 작동 시스템에 따라 연결 구성이 불가능할 수 있습니다. Bluetooth® 기기가 GATT 프로토콜을 지원해야 합니다.
- 형식판에 적힌 일련 번호 (15)를 통해 측정공구를 식별할 수 있습니다.

조립

배터리 삽입하기/교환하기

측정공구 작동에는 알칼리 망간 배터리를 사용할 것을 권장합니다.

- 작동 버튼 (7) 을 누르고 측정 핀 (8) 을 180° 젖히십시오.
- 배터리 케이스 덮개 (16) 를 열려면 스크류 캡 (21) 을 위쪽으로 젖히고, 시계 반대 방향으로 1/4 정도 돌리십시오. 스크류 캡에서 배터리 케이스 덮개를 여십시오. 배터리를 끼웁니다. 이때 배터리 케이스 안에 표시된 전극의 방향에 유의하십시오.

▶ 오랜 기간 사용하지 않을 경우 측정공구의 배터리를 빼두십시오. 배터리는 오래 두면 부식되고 방전될 수 있습니다.

▶ 지침: TrackMyTools 기능은 배터리가 끼워져 있는 경우에만 사용 가능합니다.

작동

기계 시동

- ▶ 측정공구가 켜져 있는 상태에서 자리를 비우지 말고, 사용 후에는 측정공구의 스위치를 끄십시오. 레이저빔으로 인해 다른 사람의 눈을 일시적으로 안 보이게 할 수 있습니다.
- ▶ 측정공구가 물에 젖거나 직사광선에 노출되지 않도록 하십시오.
- ▶ 극한의 온도 또는 온도 변화가 심한 환경에 측정공구를 노출시키지 마십시오. 예를 들어 장시간 차량 안에 측정공구를 두지 마십시오. 온도 변화가 심한 경우 측정공구를 작동시키기 전에 먼저 온도에 적응할 수 있게 하십시오. 극심한 온도에서나 온도 변화가 심한 환경에서 사용하면 측정공구의 정확도가 떨어질 수 있습니다.
- ▶ 측정공구가 외부와 세계 부딪히거나 떨어지지 않도록 주의하십시오. 측정공구에 외부 영향이 심하게 가해진 후에는 계속 작업하기 전에 항상 정확도를 점검해야 합니다 (참조 „거리 측정 정확도 점검“, 페이지 38).
- ▶ 측정공구에는 무선 인터페이스가 장착되어 있습니다. 비행기나 병원 등 장소에 따른 제약에 주의 하십시오.

전원 켜기/끄기

작업하는 동안 수신 렌즈 (18), 레이저빔 발사구 (19) 및 카메라 (20) 가 닫히거나 막히지 않도록 유의 하십시오. 정확한 측정이 이루어지지 않을 수 있습니다.

- 측정공구와 레이저를 켜려면 측정 버튼 (2) [▲] 을 짧게 누릅니다.
- 레이저 없는 측정공구를 켜려면 전원 버튼 (9) [⊖] 을 짧게 누릅니다.

▶ 레이저빔이 사람이나 동물에 향하지 않도록 하고, 먼 거리에서라도 레이저빔 안을 들여다 보지 마십시오.

레이저를 끄려면 전원-삭제 버튼 (9) [⏻]을 짧게 누릅니다.

카메라를 끄려면 뷰파인더 버튼 (10) 을 누르십시오.

측정공구의 전원을 끄려면 전원-삭제 버튼 (9) [⏻]을 누르고 계십시오.

측정공구의 스위치를 끌 경우 메모리에 저장된 값들과 장치 설정은 그대로 유지됩니다.

카메라

처음 측정공구의 전원을 켜면 카메라 (20) 가 자동으로 켜집니다. 전원을 끄려면 뷰파인더 버튼 (10) 을 누르십시오.

측정공구의 전원을 끌 때 카메라 설정 (ON/OFF)이 저장됩니다.

레이저 포인트의 가시성 최적화

특히 야외에서 측정공구를 사용하는 경우, 직사광선이 들어오는 곳 및 내부 공간의 긴 구간에서 사용하는 경우, 레이저 포인트가 눈에 보이지 않을 수 있습니다. 카메라를 켜는 방법 외에도 다음과 같은 설정을 통해 레이저 포인트/측정 대상의 가시성을 높일 수 있습니다.

- 디스플레이 밝기의 설정 (장치 설정)
- 버튼 (5) 을 눌러 줌 기능 사용.

측정 과정

스위치를 켜면 측정공구는 길이 측정 기능에 위치합니다. 다른 측정 기능을 사용하려면 버튼 (13) [Func]을 누르십시오. 버튼 (4) [+] 또는 버튼 (11) [-] 을 눌러 원하는 을 선택하십시오. 버튼 (13) [Func] 또는 측정 버튼 (2) [▲]을 눌러 측정 기능을 활성화시키십시오.

스위치를 켜면 측정용 기준 레벨로 측정공구의 후방 모서리가 사전 설정되어 있습니다. 기준 레벨을 변경하려면 (참조 „기준 레벨 선택하기(그림 A 참조)“, 페이지 33). 측정공구를 원하는 측정 시작 점(예: 벽)에 두십시오.

지침: 전원-삭제 버튼 (9) [⏻]을 눌러 측정공구를 켜면 측정 버튼 (2) [▲]을 짧게 눌러 레이저를 켭니다.

측정을 위해 측정 버튼 (2) [▲]을 짧게 누릅니다. 그러면 레이저빔이 꺼집니다. 다시 측정하려면 상기 과정을 반복하십시오.

연속 레이저빔이 켜져 있는 상태에서 연속 측정 기능이 작동되면 측정 버튼 (2) [▲]을 한번만 눌러도 측정이 시작됩니다.

▶ 레이저빔이 사람이나 동물에 향하지 않도록 하고, 먼 거리에서라도 레이저빔 안을 들여다 보지 마십시오.

지침: 측정값은 타입별로 0.5 초 내에, 늦어도 대략 4 초 후에 디스플레이됩니다. 측정 시간은 거리, 조명 조건 및 대상물의 반사 정도에 따라 달라질 수 있습니다. 측정을 끝낸 뒤 레이저빔은 자동으로 꺼집니다.

니다. 연속 레이저빔이 켜져 있으면 측정 후에도 전원이 꺼지지 않습니다.

기준 레벨 선택하기(그림 A 참조)

측정할 경우 네가지의 다양한 기준 레벨 중에 선택할 수 있습니다:

- 측정공구의 뒷 모서리(예: 벽면에 설치할 경우),
- 180° 접힌 측정 핀 (8) 의 팁(예: 코너에서 측정하는 경우),
- 측정공구의 앞 모서리(예: 책상 가장자리에서부터 측정할 경우),
- 나사부 (17) 의 중간(예: 삼각대를 이용하여 측정할 경우)

측정 핀 (8) 을 180°로 젖히거나 접으면 자동으로 감지하여 해당 기준 레벨을 제안합니다. 측정 버튼 (2) [▲]을 눌러 설정 내역을 승인합니다.

소프트 버튼 (3) [■]을 눌러 측정공구 설정 내역을 선택합니다. 버튼 (4) [+] 또는 버튼 (11) [-]을 눌러 기준 레벨을 선택한 후 버튼 (13) Func을 눌러 이를 승인합니다.

측정공구 켤 때마다 자동으로 측정공구의 뒤쪽 모서리가 기준면으로 사전 설정되어 있습니다.

연속 레이저빔

필요에 따라 측정공구를 연속 레이저빔 상태로 전환할 수 있습니다. 이를 위해 소프트 버튼 (3) [■]을 눌러 측정공구 설정 내역을 선택합니다. 버튼 (4) [+] 또는 버튼 (11) [-]을 눌러 연속 레이저빔을 선택한 후 버튼 (13) Func을 눌러 승인하십시오.

▶ 레이저빔이 사람이나 동물에 향하지 않도록 하고, 먼 거리에서라도 레이저빔 안을 들여다 보지 마십시오.

이 설정에서 레이저빔은 측정 중간에도 켜진 상태로 유지되며, 측정하려면 측정 버튼 (2) [▲]을 짧게 한번 눌러줘야 합니다.

연속 레이저빔은 설정에서 다시 끄거나 또는 측정공구의 전원을 끄면 꺼집니다.

“설정” 메뉴

메뉴 “설정” (i) 에 들어가려면, 소프트 버튼 (3) [■] 또는 버튼 (13) Func을 짧게 누릅니다.

버튼 (4) [+] 또는 버튼 (11) [-]을 눌러 원하는 설정 내역을 선택한 후 버튼 (13) Func을 눌러 승인하십시오. 원하는 설정을 선택하십시오.

메뉴 “설정” 에서 벗어나려면, 전원-삭제 버튼 (9) [⏻] 또는 소프트 버튼 (12) [■]을 누르십시오.

설정



	Bluetooth®
	기준면
	타이머 기능
	연속 레이저빔
	경사 측정 보정

설정

 부파인더 보정

 장치 설정

타이머 기능

타이머 기능은 예를 들어 접근하기 힘든 곳에서 측정을 하는 경우 또는 측정하는 동안 측정공구가 움직이지 않도록 해야 할 경우에 도움을 줍니다.

설정에서 타이머 기능을 선택하십시오. 측정이 이루어지기 원하는 작동 시간 간격을 선택한 후 측정 버튼 (2) [▲] 또는 버튼 (13) Func을 누르십시오.

그리고 나서 측정 버튼 (2) [▲] 을 누르면, 레이저 빔이 켜지고 목표 지점을 조준합니다. 측정 버튼 (2) [▲] 를 다시 한 번 누르면, 측정이 이루어집니다. 설정한 시간이 지나면 측정이 됩니다. 결과 표시 열 (a) 에 측정치가 표시됩니다.

상태 표시줄 상단에 측정이 이루어지는 작동 시간 간격이 표시됩니다.

타이머 기능이 설정된 경우 지속 측정 및 최소/최대 측정은 불가능합니다.

타이머는 측정공구의 전원이 꺼지기 전까지 또는 “설정” 메뉴에서 타이머가 꺼지기 전까지 설정된 상태로 유지됩니다.

“장치 설정” 메뉴

“설정” 메뉴에서 “장치 설정” 메뉴를 선택하십시오.

버튼 (4) [+] 또는 버튼 (11) [-]을 눌러 원하는 장치 설정을 선택한 후 버튼 (13) Func을 눌러 승인하십시오. 원하는 장치 설정을 선택하십시오.

메뉴 “장치 설정” (o) 에서 벗어나려면, 전원-삭제 버튼 (9) [0] 또는 소프트 버튼 (12) [■]을 누르십시오.

장치 설정



 언어

 시간 & 날짜

 측정 단위

 각도 단위

 TrackMyTools

 장치 정보

 음향 신호

 스위치 오프 시간

 감광 스위치

 디스플레이 밝기

 디스플레이 정렬

언어 설정

장치 설정에서 “언어” 를 선택하십시오. 원하는 언어를 설정한 후 버튼 (13) Func 또는 측정 버튼 (2) [▲]을 눌러 승인하십시오.

날짜 및 시간 설정

장치 설정에서 “시간 & 날짜” 를 선택하십시오. 디스플레이에 제시된 지침에 맞춰 날짜 및 시간을 설정한 후 소프트 버튼 (12) [■]을 누르십시오.

지침: 배터리 교환 후에는 날짜 및 시간을 다시 설정해야 합니다.

단위 변경하기

장치 설정에서 “측정 단위” 를 선택하십시오. 기본 설정의 측정 단위는 “m” (미터)입니다.

원하는 측정 단위를 설정한 후 버튼 (13) Func을 누르십시오.

메뉴 항목을 벗어나려면 전원-삭제 버튼 (9) [0] 또는 소프트 버튼 (3) [■]을 누르십시오. 측정공구를 끈 후에도 선택한 설정은 그대로 저장됩니다.

각도 단위 변경하기

장치 설정에서 “각도 단위” 를 선택하십시오. 기본 설정의 각도 단위는 “°” (도)입니다.

원하는 각도 단위를 설정한 후 버튼 (13) Func을 누르십시오.

메뉴 항목을 벗어나려면 전원-삭제 버튼 (9) [0] 또는 소프트 버튼 (3) [■]을 누르십시오. 측정공구를 끈 후에도 선택한 설정은 그대로 저장됩니다.

TrackMyTools

장치 설정에서 “TrackMyTools” 를 선택하십시오. 버튼 (13) [Func]을 눌러 설정 내역을 승인합니다.

첫 사용 시에는 활성화해야 합니다. 데이터는 해당 앱 또는 해당 PC 프로그램을 통해서만 전송할 수 있습니다.

TrackMyTools는 언제든지 다시 비활성화할 수 있습니다.

측정공구의 전원을 끌 때 TrackMyTools 설정(활성화/비활성화)이 저장됩니다.

지침: TrackMyTools 기능은 배터리가 끼워져 있는 경우에만 사용 가능합니다. 배터리 교환 후

TrackMyTools를 활성화하려면 잠깐 측정공구의 전원을 켜야 합니다.

디스플레이 조명

장치 설정에서 “감광 스위치” 를 선택하십시오.

디스플레이 조명은 계속 켜져 있습니다. 버튼을 누르지 않으면, 디스플레이 조명은 약 30초 후 배터리 절약을 위해 어두워집니다.

감광이 시작되는 시간을 설정할 수 있습니다(장치 설정).

디스플레이 밝기는 주변 조건에 맞춰 여러 단계로 조정할 수 있습니다(장치 설정).

측정 기능

지침: 도움말 기능 통합

측정공구에서 모든 측정 기능에 도움말이 애니메이션 형태로 저장되어 있습니다. 이를 위해 버튼 **(13) [Func]**, 버튼 **(4) [+]** 또는 **(11) [-]**을 누른 후 소프트 버튼 **(3) []**을 선택합니다. 선택한 측정 기능에 대해 애니메이션을 통해 세부 작업 절차를 보여줍니다.

애니메이션은 언제든지 **(3) []**을 눌러 정지했다가 다시 시작할 수 있습니다. 버튼 **(4) [+]** 또는 **(11) [-]**을 눌러 이동하며 스크롤할 수 있습니다.

길이 측정

길이 측정 을 선택하십시오.

레이저빔을 켜려면 측정 버튼 **(2) [▲]**을 짧게 누르십시오.

측정을 위해 측정 버튼 **(2) [▲]**을 짧게 누릅니다. 디스플레이 하단에 측정값이 표시됩니다.

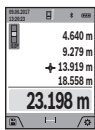

다시 측정할 때마다 상기 제시된 과정을 반복하십시오. 마지막 측정값이 디스플레이 하단에, 마지막에서 두번째 측정값이 그 위에 차례로 표시됩니다.

연속 측정

연속 측정 시 측정공구가 상대적으로 대상을 향해 움직일 수 있으며, 측정치는 0.5초마다 업데이트됩니다. 예를 들어 벽면에서 원하는 간격까지 움직일 수 있으며, 현재 거리는 항상 판독 가능합니다.

연속 측정 을 선택하십시오.

레이저빔을 켜려면 측정 버튼 **(2) [▲]**을 짧게 누르십시오.

디스플레이 하단에 원하는 거리값이 보일 때까지 측정공구를 계속 움직입니다.

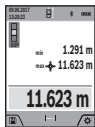

측정 버튼 **(2) [▲]**을 짧게 누르면 연속 측정이 중단됩니다. 디스플레이 하단에 현재 측정값이 표시됩니다. 최대 측정값 및 최소 측정값이 그 위에 표시됩니다. 측정 버튼 **(2) [▲]**을 다시 누르면 연속 측정이 새로 시작됩니다.

5분이 지나면 자동으로 연속 측정이 꺼집니다.

면적 측정

면적 측정 을 선택하십시오.

이어서 길이 측정 시와 같이 폭 및 깊이를 연속으로 측정하십시오. 두 측정을 하는 동안 레이저빔이 계속 켜져 있습니다. 측정해야 할 구간이 면적 측정용 표시기 에서 깜박입니다(표시 요소 **(j)** 참조).

첫 번째 측정값이 디스플레이 상단에 표시됩니다.

두 번째 측정이 끝난 후에 면적이 자동으로 계산되어 표시됩니다. 최종 결과가 디스플레이 하단에, 개별 측정값이 그 위에 표시됩니다.

체적 측정

체적 측정 을 선택하십시오.

이어서 길이 측정 시와 같이 폭, 길이 그리고 깊이를 연속으로 측정하십시오. 세 가지 측정이 이루어지는 사이에 레이저빔은 켜진 상태로 유지됩니다. 측정해

야 할 구간이 체적 측정용 표시기 에서 깜박입니다(표시 요소 **(j)** 참조).

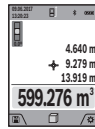

첫 번째 측정값이 디스플레이 상단에 표시됩니다.

두 번째 측정이 끝난 후에 체적이 자동으로 계산되어 표시됩니다. 최종 결과가 디스플레이 하단에, 개별 측정값이 그 위에 표시됩니다.

간접 거리 측정

간접 거리 측정 을 선택하십시오. 간접 거리 측정의 경우 네 가지 측정 기능이 제공되어 상황에 맞춰 다양한 구간을 측정할 수 있습니다.

간접 거리 측정 기능은 장애물이 있어 레이저빔 측정이 불가능하거나 표적면을 반사체로 이용할 수 없어 거리를 직접 측정할 수 없을 경우 사용할 수 있습니다. 이 측정방법은 수직 방향으로만 사용할 수 있습니다. 수평 방향으로 사용하면 측정 오류가 발생할 수 있습니다.

지침: 간접적인 거리 측정은 항상 직접적인 거리 측정보다 정확도가 떨어집니다. 측정 오류는 사용에 따라 직접적인 거리 측정 시보다 점점 더 커집니다. 측정 정확도를 높이기 위해 삼각대(부속품)를 사용하면 좋습니다. 개별 측정을 하는 동안 레이저빔은 켜져 있습니다.

a) 간접 높이 측정(그림 B 참조)

간접 높이 측정 을 선택하십시오.

이때 측정공구가 아래 측정점과 동일한 위치에 있도록 해야 합니다. 그리고 나서 측정공구를 기준면 둘레에 기울이고 거리 측정할 때와 같이 구간

"1" (디스플레이에 붉은색 라인으로 표시됨)을 측정하십시오.

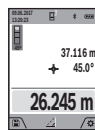

측정을 마치고 나면 구하려는 구간 **"X"**가 결과 표시열 **(a)**에 표시됩니다. 구간 **"1"**에 대한 측정치 및 각도 **"α"**는 측정치 표시열 **(h)**에 표시됩니다.

b) 이중 간접 높이 측정(그림 C 참조)

측정공구를 통해 측정공구의 수직면에 놓인 모든 구간을 간접적으로 측정할 수 있습니다. 이중 간접 높이 측정 을 선택하십시오. 길이 측정할 때와 같이 구간 **"1"** 및 **"2"**를 순서대로 측정하십시오.

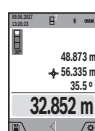

측정을 마치고 나면 구하려는 구간 **"X"**가 결과 표시열 **(a)**에 표시됩니다. 구간 **"1"**, **"2"**에 대한 측정치 및 각도 **"α"**는 측정치 표시열 **(h)**에 표시됩니다.

이때 측정 기준점(측정공구의 뒷 모서리 등)이 측정 과정 중 모든 개별 측정 시에 정확히 동일한 위치에 있어야 합니다.

c) 간접 길이 측정(그림 D 참조)

간접 길이 측정 을 선택하십시오.

이때 측정공구가 구하려는 측정점과 동일한 높이에 있도록 해야 합니다. 그리고 나서 측정공구를 기준면 둘레에 기울이고 길이 측정할 때와 같이 구간 **"1"**을 측정하십시오.

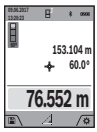

측정을 마치고 나면 구하려는 구간 "X"가 결과 표시열 (a)에 표시됩니다. 구간 "1"에 대한 측정치 및 각도 "α"는 측정치 표시열 (h)에 표시됩니다.

d) 사다리꼴 측정(그림 E 참조)

예를 들어 지붕의 경사 길이를 측정할 경우에는 사다리꼴 측정을 사용할 수 있습니다.

사다리꼴 측정 을 선택하십시오.

길이 측정할 때와 같이 구간 "1" "2" 및 "3"를 순서대로 측정하십시오. 구간 "3" 측정은 정확하게 구간 "1"의 최종 지점에서 시작하고 구간 "1"과 "2"사이 및 "1"과 "3"사이에서 직각을 이뤄야 함에 유의하십시오.

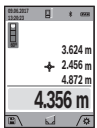

마지막 측정을 마치고 나면 구하려는 구간 "X"가 결과 표시열 (a)에 표시됩니다. 측정치 표시열 (h)에 개별 측정치가 적혀 있습니다.

벽 면적 측정(그림 F 참조)

벽 면적 측정은 높이가 동일한 여러 단면적의 합한 값을 구하는데 사용할 수 있습니다. 제시된 예시에서는 공간의 높이 H는 같지만, 길이 L이 서로 다른 여러 벽의 전체 면적을 산출해야 합니다.

벽 면적 측정 을 선택하십시오.

길이 측정할 때와 같이 공간 높이 H를 측정하십시오. 상단 측정값행에 해당 측정값이 표시됩니다. 레이저는 켜진 상태입니다.

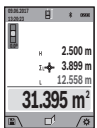

그리고 나서 첫 번째 벽의 길이 L₁을 측정하십시오. 면적이 자동으로 계산되어 결과 표시열 (a)에 표시됩니다. 마지막 길이 측정값은 하단 측정치 표시열 (h)에 표시됩니다. 레이저는 켜진 상태입니다.

이제 두 번째 벽의 길이 L₂를 측정하십시오. 측정치 표시열 (h)에 표시된 개별 측정값은 길이 L₁에 합산됩니다. 두 길이를 합한 값(중간 측정치 표시열 (h)에 표시)에 저장된 높이 H가 곱해집니다. 결과 표시열 (a)에 전체 면적 측정값이 표시됩니다.

입의로 여러 개의 다른 길이 L_x를 측정할 수 있으며, 측정된 값은 자동으로 합산되고 높이 H와 곱하여 계산됩니다. 정확하게 면적을 산출하려면 첫 번째로 측정된 길이(예시에서는 공간 높이 H)가 모든 측정 부분에서 동일해야 합니다.

분리 기능(그림 G 참조)

분리 기능을 통해 반복하여 정해진 길이(구간)를 측정합니다. 한 표면에서 정해진 길이 전송이 가능하며, 작업 소재를 동일한 길이로 절단하거나 건축 벽에 스타드 월을 설치할 때 등에 활용할 수 있습니다. 설정 가능한 최소 길이는 0.1 m이며, 최대 길이는 50 m입니다.

지침: 분리 기능에서 표시된 부분까지의 간격이 디스플레이에 표시됩니다. 측정공구의 모서리는 기준점이 아닙니다.

분리 기능 을 선택하십시오.

버튼 (4) [+] 또는 버튼 (11) [-]을 눌러 원하는 길이를 설정하십시오.

측정 버튼 (2) [▲]을 눌러 시작한 후, 시작 지점에서 서서히 벗어나십시오.

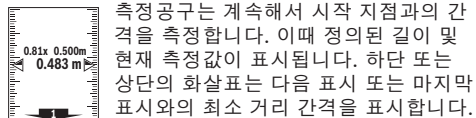

측정공구는 계속해서 시작 지점과의 간격을 측정합니다. 이때 정의된 길이 및 현재 측정값이 표시됩니다. 하단 또는 상단의 화살표는 다음 표시 또는 마지막 표시와의 최소 거리 간격을 표시합니다.

지침: 계속해서 측정을 진행할 경우 측정 버튼 (2) [▲]을 눌러 측정된 값을 정의된 길이로 설정할 수도 있습니다.

좌측의 계수는 정의된 길이에 얼마나 도달했는지 알려줍니다. 디스플레이 측면의 녹색 화살표는 길이에 도달했음을 표시하기 위한 목적으로 나타냅니다.

기준값이 디스플레이 영역을 벗어난 경우, 적색 화살표 또는 적색 문자 표시가 실제값을 나타냅니다.

경사 측정/디지털 수준기

경사도 측정/디지털 수준기 를 선택하십시오. 측정공구는 두 가지 상태 사이에서 자동으로 전환됩니다.

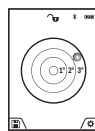

디지털 수준기는 (예를 들어 세탁기, 냉장고 등) 물체의 수평 또는 수직 방향을 점검하는 데 사용됩니다.

경사가 3°를 초과하면, 디스플레이의 구가 적색으로 점등됩니다.

측정공구의 아랫면은 디지털 수준기의 기준 레벨 역할을 합니다.

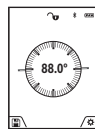

경사 측정은 (예를 들어 계단, 난간, 가구를 들어올 때, 파이프를 배선할 때 등) 경사 또는 기울기를 측정하는 데 사용됩니다.

측정공구의 좌측은 경사 측정을 위한 기준점 역할을 합니다. 측정 과정 중에 표시기가 깜박이면 측정공구가 지나치게 옆으로 기울어졌기 때문입니다.

메모리 기능

측정이 종료될 때마다 해당 값 또는 최종 결과는 자동으로 저장됩니다.

메모리값 표시기

최대 50개의 값(측정값 또는 측정값이 포함된 사진)을 불러올 수 있습니다.

소프트 버튼 (12) 을 눌러 저장 기능을 선택하십시오.

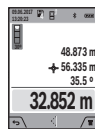

디스플레이 상단에 메모리 값의 번호가 표시되고, 하단에는 해당 메모리 값과 해당 측정 기능이 표시됩니다.

저장된 값들을 앞으로 넘기려면 버튼 (4) +를 누릅니다.

저장된 값들을 뒤로 넘기려면 버튼 (11) -을 누릅니다.

메모리에 저장된 값이 없으면, 디스플레이 하단에 "0.000" 및 상단에 "0"이 표시됩니다.

(제공되는 50개의 메모리 값 중에서) 가장 오래된 값은 메모리의 위치 1에, 마지막 값은 위치 50에 위치합니다. 다른 값을 저장하면 항상 메모리에서 가장 오래된 값이 삭제됩니다.

메모리 삭제하기

메모리를 열려면 소프트 버튼 (12) []을 누르십시오. 측정값을 삭제하려면 원하는 만큼 지금까지와 반대 순서로 소프트 버튼 (3) []을 누르십시오. 메모리 내용 전체를 삭제하려면 소프트 버튼 (3) [] 및 줌 버튼 (5) 을 누르십시오.

값 더하기/빼기

측정값 또는 최종 결과는 더하거나 뺄 수 있습니다.

값 더하기

다음과 같은 예시는 면적 더하는 방식을 설명합니다: “면적 측정” 단락에 따라 면적을 산출하십시오 (참조 „면적 측정“, 페이지 35).

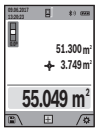

버튼 (4) [+] 을 누르십시오. 산출된 면적 및 기호 “+” 가 표시됩니다. 다른 면적 측정을 시작하려면 다시 측정 버튼 (2) [▲]을 누르십시오. “면적 측정” 단락에 따라 면적을 산출하십시오 (참조 “면적 측정“, 페이지 35). 두 번째 측정이 완료되면, 두 번째 면적 측정의 결과가 디스플레이 하단에 표시됩니다. 최종 결과를 나타내려면 다시 측정 버튼 (2) [▲]을 누르십시오.

지침: 길이 측정 시에는 결과가 즉시 표시됩니다.

값 빼기

값을 빼려면 버튼 (11) [-] 을 누르십시오. 다른 작업 절차는 “값 더하기”와 동일하게 진행됩니다.

측정치 삭제하기

모든 측정 기능에서 전원-삭제 버튼 (9) []을 짧게 눌러서 마지막으로 측정된 값을 삭제할 수 있습니다.

Bluetooth® 인터페이스

다른 기기로의 데이터 전송

본 측정공구에는 Bluetooth® 모듈이 장착되어 있으며, 이 모듈은 무선 기술을 이용하여 Bluetooth® 인터페이스가 있는 특정한 모바일 단말기에 데이터를 전송합니다(예: 스마트폰, 태블릿).

블루투스® 연결에 필요한 시스템 전제조건에 관한 정보는 보쉬 인터넷 사이트 www.bosch-pt.com에서 확인할 수 있습니다.

▶ 보다 상세한 정보는 보쉬 제품 사이트에서 확인할 수 있습니다.

Bluetooth® 를 이용하여 데이터를 전송할 경우 모바일 단말기와 측정공구 간에 시간 지연이 있을 수 있습니다. 이는 두 기기 간의 거리 때문일 수도 있고, 측정 대상 자체에 원인이 있을 수도 있습니다.

모바일 단말기로 데이터를 전송하기 위해

Bluetooth® 인터페이스 활성화

Bluetooth® 인터페이스 활성화는 설정에서 이루어 집니다. Bluetooth® 신호를 활성화하려면 버튼 (4) [+] 을 누르십시오. 모바일 단말기에 있는 Bluetooth® 인터페이스가 활성화되었는지 확인하십시오.

모바일 단말기의 기능 범위를 넓히고 데이터 처리를 간소화하기 위해 전용 보쉬 애플리케이션(앱)

“Measuring Master” 를 사용할 수 있습니다. 단말기에 따라 해당 스토어에서 다운받으실 수 있습니다.

보쉬 애플리케이션을 시작하면 모바일 단말기와 측정공구 사이에 연결이 생성됩니다. 활성화된 여러 개의 측정공구 중에 일련 번호에 따라 적합한 것을 고르십시오. 일련 번호 (15) 는 측정공구의 타입 표시판에 적혀 있습니다.

연결 상태 및 활성화된 연결 (f) 은 측정공구의 디스플레이 (1) 에 표시됩니다.

Bluetooth® 인터페이스 비활성화

Bluetooth® 연결 비활성화는 설정에서 이루어 집니다. Bluetooth® 신호를 비활성화하려면 버튼 (11) [-] 을 누르거나 측정공구의 전원을 끄십시오.

사용 방법

- ▶ 보다 상세한 정보는 보쉬 제품 사이트에서 확인할 수 있습니다.
- ▶ 측정공구에는 무선 인터페이스가 장착되어 있습니다. 비행기나 병원 등 장소에 따른 제약에 주의하십시오.

일반 사항

측정 시 수신 렌즈 (18), 레이저범 발사구 (19) 및 카메라 (20) 가 가려지지 않도록 하십시오.

측정공구는 측정 중 움직임이 있어서는 안 되므로 최대한 접촉면에 단단히 고정되도록 하십시오.

측정 범위에 미치는 영향

측정 범위는 조명 조건 및 표적면의 반사 정도에 따라 달라질 수 있습니다. 외부 광선이 강한 경우 레이저범을 더 잘 알아볼 수 있도록 내장된 카메라 (20), 레이저 보안경 (26) (액세서리) 및 레이저 표적판 (25) (액세서리)을 사용하거나, 대상면을 어둡게 하십시오.

측정 결과에 미치는 영향

다양한 표면에 측정할 경우 물리적인 이유로 인해 측정 오류가 생길 수 있습니다. 예:

- 투명한 표면(예: 유리, 물)
- 반사 표면(예: 광택 처리된 금속, 유리)
- 기공 표면(예: 단열재)
- 구조화된 표면(예: 초박철, 천원 석재)

이러한 표면에는 필요에 따라 레이저 표적판 (25) (액세서리)을 사용하십시오.

표적면에 비스듬히 조준한 경우 측정 오류가 생길 수 있습니다.
또한 공기층의 온도가 상이하거나 혹은 간접적인 반사가 이루어진 경우에도 측정 결과에 지장이 있을 수 있습니다.

정확도 점검 및 경사 측정 보정(그림 H 참조)

경사 측정의 정확도를 정기적으로 검사하십시오. 이는 역측정으로 이루어집니다. 우선 측정공구를 책상 위에 놓고 그 경사를 측정합니다. 측정공구를 180° 돌린 후 다시 경사를 측정합니다. 표시된 숫자의 편차가 최대 0.3° 이하여야 합니다.
편차가 클 경우 측정공구를 새로 재보정해야 합니다. 이를 위해 설정에서 **꺾** 을 선택하십시오. 디스플레이에 나온 지시대로 따르십시오.
심한 온도 변화를 겪었거나 충격을 받은 경우, 측정공구의 정확도를 점검해 본 후 필요에 따라 보정하기를 권장합니다. 온도 변화 후 측정공구를 보정하기 전에, 일정 시간동안 측정공구가 온도에 적응할 수 있도록 해야 합니다.

거리 측정 정확도 점검

측정공구의 정확도는 다음과 같이 점검할 수 있습니다.

- 길이가 정확히 알려져 있는 약 3 m에서 10 m 사이의 장기간 변화하지 않는 측정 구간을 선택하십시오(예: 공간 폭이나 문 크기 등). 측정은 적절한 조건 하에서 이루어져야 합니다. 즉, 측정 구간이 배경 조명이 약한 상태에서 실내 공간 내에 위치해야 하며 측정 표적면은 매끄럽고 잘 반사되어야 합니다(예: 흰색으로 칠한 벽).
- 해당 구간을 10회 연속으로 측정하십시오.
적절한 조건 하의 전체 측정 구간에서 평균값과 개별 측정에서 나타나는 편차는 최대 ±2 mm 정도 되어야 합니다. 추후에 정확도를 비교할 수 있도록 측정치를 기록해 놓으십시오.

뷰파인더(십자선)의 정확도 점검 및 보정

레이저 및 뷰파인더의 정렬 상태의 정확도를 주기적으로 점검하십시오.

- 타겟으로 최소 5 m 이상 떨어진 곳에서 조명이 최소화된 밝은 면(예: 흰색으로 칠한 벽)을 선택하십시오.
- 레이저 포인트가 디스플레이의 뷰파인더 내에 위치하는지 점검하십시오.

레이저 포인트가 뷰파인더 내에 위치하지 않는 경우, 뷰파인더를 새로 보정해야 합니다.

이를 위해 설정에서 **꺾** 을 선택하십시오. 디스플레이에 나온 지시대로 따르십시오.

(5 m가 넘는) 긴 거리에서는 측정 지점 표시를 위해 대상을 표시도 화면에 나타냅니다.

삼각대(액세서리)를 이용해 작업하기

특히 먼거리를 측정할 때 삼각대를 사용하는 것이 필요합니다. 1/4" 나사부 (17) 와 함께 측정공구를

삼각대 (27) 의 순간 교환 플레이트 혹은 일반 카메라 삼각대 위에 놓습니다. 그리고 나서 이를 순간 교환 플레이트의 고정 나사를 사용하여 고정하십시오. 설정에서 측정을 위한 기준 레벨을 설정하십시오 (삼각대 기준 레벨).

고장 - 원인 및 대책

원인	해결 방법
온도 경고가 깜박이고, 측정이 불가능한 경우	
측정공구가 작동 온도 - 10 °C ~ +45 °C를 벗어 나 있습니다(연속 측정 기능 사용 시 최대 +40 °C까지).	측정공구가 작동 온도에 도달할 때까지 기다리십시오.
디스플레이에 "Error" 표시	
측정 단위가 서로 다른 측정치를 더하거나 빼 우입니다.	동일한 측정 단위의 측정치를 더하거나 빼십시오.
레이저빔과 표적 간의 각도가 좁습니다.	레이저빔과 표적 간의 각도를 넓힙니다.
표적면 반사가 너무 심하거나(예: 거울) 너무 약하거나(예: 검은색 소재) 또는 주변 조명이 너무 강합니다.	레이저 표적판 (25) (액세서리) 사용하십시오.
레이저빔 발사구 (19), 수신 렌즈 (18) 또는 카메라 (20) 에 김이 서렸 습니다(예: 급속한 온도 변경).	부드러운 천으로 레이저 빔 발사구 (19), 수신 렌즈 (18) 또는 카메라 (20) 를 닦아주십시오.
산출된 값은 1 999 999 보다 크거나 -999 999 m ² /m ³ 보다 작 습니다.	측정을 나누어서 하십시오.
디스플레이에 "CAL" 또는 "Error" 표시	
경사 측정의 재보정이 정 확한 순서대로 이루어 지 않았거나 올바른 위치 에서 실시되지 않았 습니다.	디스플레이와 사용 설명서에 나온 대로 재보정을 반복하십시오.
재보정에 사용된 표면이 정확히 수직이나 수평으 로 맞추어지지 않았 습니다.	수직이나 수평의 표면에 다시 재보정하고, 경우에 따라 수준기를 사용하여 먼저 표면을 확인해 보십시오.
버튼을 누를 때 측정공구 가 움직이거나 기울어졌 습니다.	재보정을 반복하고 버튼 을 누를 때 측정공구를 표면 위에서 가만히 잡은 채 유지하십시오.
측정결과가 타당하지 않음	
표적면이 명확하게 반사 되지 않습니다(예: 물, 유리).	표적면을 가려주십시오.



อย่าส่องลำแสงเลเซอร์ไปยังคนหรือสัตว์ และ
ตัวท่านเองอย่างจงมองเข้าไปในลำแสงเลเซอร์
โดยตรงหรือลำแสงเลเซอร์สะท้อน การกระ
ทำดังกล่าวอาจทำให้คนตาพร่า ทำให้เกิด
อุบัติเหตุ หรือทำให้ดวงตาเสียหายได้

- ▶ ถ้าแสงเลเซอร์เข้าตา ต้องปิดตาและหันศีรษะออกจาก
ลำแสงในทันที
 - ▶ อย่าทำการเปลี่ยนแปลงใดๆ ที่อุปกรณ์เลเซอร์
 - ▶ อย่าใช้แว่นสำหรับมองแสงเลเซอร์เป็นแว่นนิรภัย แว่น
สำหรับมองแสงเลเซอร์ใช้สำหรับมองลำแสงเลเซอร์ให้
เห็นชัดเจนยิ่งขึ้น แต่ไม่ได้ช่วยป้องกันรังสีเลเซอร์
 - ▶ อย่าใช้แว่นสำหรับมองแสงเลเซอร์เป็นแว่นกันแดดหรือ
ใส่ขั้วรถยนต์ แว่นสำหรับมองแสงเลเซอร์ไม่สามารถ
ป้องกันรังสีอัลตราไวโอเล็ต (UV) ได้อย่างสมบูรณ์ และ
ยังลดความสามารถในการมองเห็นสี
 - ▶ ส่งเครื่องมือวัดให้ช่างผู้เชี่ยวชาญตรวจ
ซ่อมและ ไขอะไหล่เปลี่ยนของแทนนั้น
ทั้งนี้เพื่อให้อุ่นใจได้ว่าจะสามารถใช้งานเครื่องมือ
วัดได้อย่างปลอดภัยเสมอ
 - ▶ อย่าให้เด็กใช้เครื่องมือวัดด้วยเลเซอร์โดยไม่ควบคุม
ดูแล เด็กๆ อาจทำให้คนตาพร่าโดยไม่ตั้งใจ
 - ▶ อย่าใช้เครื่องมือวัดในสภาพแวดล้อมที่เสี่ยงต่อการ
ระเบิด ซึ่งเป็นที่ที่มีของเหลว แก๊ส หรือฝุ่นที่ติดไฟได้
ในเครื่องมือวัดสามารถเกิดประกายไฟซึ่งอาจจุดฝุ่นละออง
หรือไอระเหยให้ติดไฟได้
 - ▶ ระวัง! การใช้เครื่องมือวัดกับ Bluetooth® อาจ
รบกวนอุปกรณ์และระบบอื่นๆ เครื่องบิน และอุปกรณ์
ทางการแพทย์ (ต. ย. เช่น เครื่องกระตุ้นหัวใจ เครื่อง
ช่วยฟัง) นอกจากนี้ยังอาจเกิดความเสียหายต่อคนและ
สัตว์ในบริเวณใกล้เคียงด้วย อย่าใช้เครื่องมือวัดกับ
Bluetooth® ใกล้เคียงทางการแพทย์ สถานี
บริการน้ำมัน โรงงานเคมี พื้นที่ที่เสี่ยงต่อการระเบิด
และในพื้นที่ทำการระเบิด อย่าใช้เครื่องมือวัดกับ
Bluetooth® ในเครื่องบิน หลีกเลี่ยงการทำงานเป็น
ระยะเวลานานตรงบริเวณใกล้ร่างกายโดยตรง
- เครื่องหมายข้อความ Bluetooth® และโลโก้เป็น
เครื่องหมายการค้าจดทะเบียนและเป็นกรรมสิทธิ์ของ
Bluetooth SIG, Inc. บริษัท Robert Bosch Power
Tools GmbH ได้รับใบอนุญาตใช้งานเครื่องหมาย
ข้อความ/โลโก้ดังกล่าวแล้ว

รายละเอียดผลิตภัณฑ์และข้อมูล

จำเพาะ

กรุณาดูภาพประกอบในส่วนหน้าของคู่มือการใช้งาน

ประโยชน์การใช้งาน

เครื่องมือวัดนี้ใช้สำหรับวัดระยะทาง ความยาว ความสูง ช่อง
ว่าง ความลาดชัน และสำหรับคำนวณพื้นที่และปริมาตร
ผลจากการวัดสามารถถ่ายโอนไปยังอุปกรณ์อื่นๆ ผ่าน
Bluetooth®

เครื่องมือวัดนี้เหมาะสำหรับใช้งานทั้งภายในและภายนอก
อาคาร

ส่วนประกอบผลิตภัณฑ์

ลำดับเลขของส่วนประกอบอ้างอิงถึงส่วนประกอบของเครื่องมือ
วัดที่แสดงในหน้าภาพประกอบ

- (1) จอแสดงผล
- (2) ปุ่มวัด [▲] (ใช้ได้ด้านหน้าหรือด้านหลัง)
- (3) ซอฟต์แวร์ [■]
- (4) ปุ่มบวก [+] / เลือกไปทางขวา
- (5) ปุ่มชม
- (6) ที่เกี่ยวสายหิ้ว
- (7) ปุ่มปลดล๊อค หมุดวัด
- (8) หมุดวัด
- (9) ปุ่มเปิด-ปิด-ลบ [○]
- (10) ปุ่มช่องมองภาพ
- (11) ปุ่มลบ [-] / เลือกไปทางซ้าย
- (12) ซอฟต์แวร์ [■]
- (13) ปุ่มฟังก์ชัน [Func]
- (14) ป้ายเตือนแสงเลเซอร์
- (15) หมายเลขเครื่อง
- (16) ฝาช่องใส่แบตเตอรี่
- (17) เกลียขาตั้งแบบสามขา 1/4"
- (18) เลนส์รับแสง
- (19) ทางออกลำแสงเลเซอร์
- (20) กล้องถ่ายรูป
- (21) สลักหมุน
- (22) แบตเตอรี่
- (23) กระเป๋าสีใส่เครื่องมือวัด
- (24) สายหิ้ว
- (25) แผ่นเป้าหมายเลเซอร์^{A)}
- (26) แวนตาสำหรับมองแสงเลเซอร์^{A)}

(27) ขาดังแบบสามขา^{A)}

- A) อุปกรณ์ประกอบที่แสดงภาพหรืออธิบายไม่รวมอยู่ในการจัดส่งมาตรฐาน
กรุณาดูอุปกรณ์ประกอบทั้งหมดในรายการแสดงอุปกรณ์ประกอบของเรา

ชิ้นส่วนแสดงผล

- (a) บรรทัดผลลัพธ์
(b) ช่องมองภาพ (กากบาท)
(c) สัญลักษณ์ มุมเอียง
(d) วันที่/เวลา
(e) ระนาบอ้างอิงของการวัด
(f) สถานะการเชื่อมต่อ
✳ Bluetooth® ไม่ถูกเรียกใช้งาน
✳))) Bluetooth® ถูกเรียกใช้งาน มีการเชื่อมต่อ
(g) ไฟแสดงสถานะการชาร์จแบตเตอรี่
(h) บรรทัดแสดงค่าจากการวัด
(i) การตั้งค่า (ซอฟต์แวร์)
(j) ฟังก์ชันการวัดที่เลือก
(k) หน่วยความจำภายใน (ซอฟต์แวร์)
(l) ฟังก์ชันความช่วยเหลือเบ็ดเสร็จ (ซอฟต์แวร์)
(m) ย้อนกลับ (ซอฟต์แวร์)
(n) หน้าจอเริ่มต้น (ซอฟต์แวร์)
(o) การตั้งค่าอุปกรณ์

ข้อมูลทางเทคนิค

เครื่องวัดระยะด้วยเลเซอร์แบบดิจิทัล	GLM 150 C
หมายเลขสินค้า	3 601 K72 F..
ช่วงการวัด (ปกติ)	0.08–150 ม. ^{A)}
ช่วงการวัด (ปกติ สภาวะที่ไม่เหมาะสม)	0.08–60 ม. ^{B)}
ความแม่นยำการวัด (ปกติ)	±1.5 มม. ^{A)}
ความแม่นยำการวัด (ปกติ สภาวะที่ไม่เหมาะสม)	±3.0 มม. ^{B)}
หน่วยแสดงการวัดต่ำสุด	0.5 มม.
การวัดระยะทางทางอ้อมและระดับน้ำ	
ช่วงการวัด	0°–360° (4x90°)
การวัดความลาดชัน	

เครื่องวัดระยะด้วยเลเซอร์แบบดิจิทัล	GLM 150 C
ช่วงการวัด	0°–360° (4x90°)
ความแม่นยำการวัด (ปกติ)	±0.2 ^{oC/D/E)}
หน่วยแสดงการวัดต่ำสุด	0.1°
ทั่วไป	
อุณหภูมิใช้งาน	-10 °C ... +45 °C ^{F)}
อุณหภูมิเก็บรักษา	-20 °C ... +70 °C
ช่วงอุณหภูมิที่อนุญาตให้ชาร์จ	+5 °C ... +40 °C
ความชื้นสัมพัทธ์ สูงสุด	90 %
ความสูงใช้งานเหนือระดับอ้างอิง สูงสุด	2000 ม.
ระดับมลพิษตาม IEC 61010-1	2 ^{G)}
ระดับเลเซอร์	2
ชนิดเลเซอร์	650 นาโนเมตร, < 1 มิลลิวัตต์
เส้นผ่านศูนย์กลางลำแสงเลเซอร์ (ที่ 25 °C) โดยประมาณ	
- ที่ระยะ 10 ม.	9 มม.
- ที่ระยะ 100 ม.	90 มม.
ระบบปิดสนิทข้อดีโนมิติ ภายในประมาณ	
- เลเซอร์	20 วินาที
- เครื่องมือวัด (เมื่อไม่มี การวัด)	5 นาที ^{H)}
แบตเตอรี่	3 x 1.5 V LR6 (AA)
น้ำหนักตามระเบียบการ-EPTA-Procedure 01:2014	0.23 กก.
ขนาด	142 (176) x 64 x 28 มม.
ระดับการคุ้มกัน	IP 54 (ป้องกันฝุ่นและน้ำกระเด็นเป็ยิก)
การถ่ายทอดข้อมูล	
Bluetooth®	Bluetooth® (4.2 low energy) ^{I)}
ย่านความถี่ใช้งาน	2402 – 2480 เมกะเฮิรตซ์

เครื่องวัดระยะด้วยเลเซอร์ GLM 150 C แบบดิจิทัล

กำลังส่ง สูงสุด 8 มิลลิวัตต์

- A) สำหรับการวัดจากขอบหน้าของเครื่องมือวัด ไซ้ได้กับเป้าหมายที่มีการสะท้อนแสงมาก (ต. ย. เช่น ผนังทาสีขาว) แสงไฟพื้นหลังอ่อน และอุณหภูมิใช้งาน 25 °C นอกจากนี้ต้องนำส่วนเบี่ยงเบน ± 0.05 มม./ม. มาพิจารณาด้วย
- B) สำหรับการวัดจากขอบหน้าของเครื่องมือวัด ไซ้ได้กับเป้าหมายที่มีการสะท้อนแสงมาก (ต. ย. เช่น ผนังทาสีขาว) และแสงไฟพื้นหลังแรง นอกจากนี้ต้องนำส่วนเบี่ยงเบน ± 0.15 มม./ม. มาพิจารณาด้วย
- C) หลังการสอบเทียบที่ 0° และ 90° ข้อผิดพลาดความลาดเอียงเพิ่มเติมสูงสุด $\pm 0.01^\circ$ /องศา ถึง 45° ความแม่นยำการวัดหมายถึงการสอบเทียบการวัดความลาดชันโดยจัดวางสามมิติทาง ภาพประกอบ H
- D) ที่อุณหภูมิใช้งาน 25 °C
- E) สำหรับการวัดความลาดชัน ให้ใช้ด้านซ้ายของเครื่องมือวัดเป็นระนาบอ้างอิง
- F) ในฟังก์ชันการวัดต่อเนื่องอุณหภูมิใช้งานสูงสุดคือ +40 °C
- G) มลพิษที่ไม่นำไฟฟ้าเท่านั้น ซึ่งในบางครั้งจะกลายเป็นนำไฟฟ้าได้ชั่วคราวเนื่องจากการกัณต์ตัวที่ไดคาดว่าจะเป็นเกิดขึ้น
- H) เวลาเปิดเครื่องอัตโนมัติสามารถปรับได้ (2, 5, 10 นาที หรือไม่มีเปิด)
- I) สำหรับอุปกรณ์ Bluetooth® Low Energy อาจไม่มีการเชื่อมต่อ ทั้งนี้ขึ้นอยู่กับรุ่นและระบบปฏิบัติการ อุปกรณ์ Bluetooth® ต้องสนับสนุน GATT-Profile

หมายเลขเครื่อง (15) บนแผ่นป้ายรุ่นมีไว้เพื่อระบุเครื่องมือวัดของท่าน

การติดตั้ง

การใส่/การเปลี่ยนแบตเตอรี่

สำหรับการใช้งานเครื่องมือวัด ขอแนะนำให้ใช้แบตเตอรี่อัลคาไลน์แมงกานีส

- กดปุ่มปลดล็อก (7) และกางหมุดวัด (8) ออก 180°
- หากต้องการเปิดฝาช่องใส่แบตเตอรี่ (16) ให้พลิกสลักหมุน (21) ขึ้นและหมุนทวนเข็มนาฬิกาไปหนึ่งในสี่ของรอบ เปิดฝาช่องใส่แบตเตอรี่โดยดึงสลักหมุนขึ้น ใส่แบตเตอรี่เข้าไป ขณะใส่แบตเตอรี่ต้องดูให้ขั้วแบตเตอรี่อยู่ในตำแหน่งที่ถูกต้องตามที่กำหนดไว้ที่ด้านในช่องใส่แบตเตอรี่

▶ **เมื่อไม่ใช้งานเครื่องมือวัดเป็นเวลานาน ต้องถอดแบตเตอรี่ออก** แบตเตอรี่สามารถกักครอนในระหว่างเก็บรักษาเป็นเวลานาน และปล่อยประจุออกเองได้

▶ **ข้อสังเกต:** TrackMyTools ทำงานเฉพาะเมื่อมีแบตเตอรี่ใส่อยู่เท่านั้น

การปฏิบัติงาน

การเริ่มต้นปฏิบัติงาน

- ▶ **อย่าวางเครื่องมือวัดที่เปิดสวิตช์ทิ้งไว้โดยไม่มีผู้ดูแล และปิดสวิตช์เครื่องมือวัดเมื่อเลิกใช้งาน** คนอื่นอาจตาพร่าจากแสงเลเซอร์ได้
- ▶ **ป้องกันไม่ให้เครื่องมือวัดได้รับความชื้นและโดนแสงแดดส่องโดยตรง**
- ▶ **อย่าให้เครื่องมือวัดได้รับอุณหภูมิที่สูงมาก หรือรับอุณหภูมิที่เปลี่ยนแปลงมาก** ต. ย. เช่น อายาปล่อยเครื่องมือไว้ในรถยนต์เป็นเวลานาน ในกรณีที่อุณหภูมิมีการเปลี่ยนแปลงมาก ต้องปล่อยให้เครื่องมือวัดปรับตัวเข้ากับอุณหภูมิรอบด้านก่อนใช้งาน ในกรณีที่ได้รับอุณหภูมิที่สูงมากหรือรับอุณหภูมิที่เปลี่ยนแปลงมาก เครื่องมือวัดอาจมีความแม่นยำน้อยลง
- ▶ **หลีกเลี่ยงอย่าให้เครื่องมือวัดตกหล่นหรือถูกกระทบอย่างรุนแรง** เมื่อเครื่องมือวัดถูกกระทบจากภายนอกอย่างรุนแรง ขอแนะนำให้ทำการตรวจสอบความแม่นยำทุกครั้งก่อนนำมาใช้งานต่อ (ดู "การตรวจสอบความแม่นยำของการวัดระยะทาง", หน้า 49)
- ▶ **เครื่องมือวัดมีอินเตอร์เฟซคลื่นวิทยุสำหรับเชื่อมโยงสื่อสารแบบไร้สาย ต้องปฏิบัติตามข้อกำหนดการทำงานในพื้นที่ ต. ย. เช่น ในเครื่องมืออื่น หรือโรงพยาบาล**

การเปิด-ปิดเครื่อง

ขณะทำงาน ต้องตรวจสอบให้แน่ใจว่าเลนส์รับแสง (18) ทางออกลำแสงเลเซอร์ (19) และกล้องถ่ายรูป (20) ไม่ถูกปิดหรือบดบัง มิฉะนั้นจะไม่สามารถวัดค่าได้อย่างถูกต้อง

- **เปิดสวิตช์** เครื่องมือวัดและเลเซอร์โดยกดปุ่มวัด (2) [▲] ที่อยู่ด้านบนหรือด้านข้างสั้นๆ
- **เปิดสวิตช์** เครื่องมือวัดแต่ไม่เปิดเลเซอร์โดยกดปุ่มเปิด-ปิด-ลบ (9) [0] สั้นๆ
- ▶ **อย่าส่องลำแสงเลเซอร์ไปยังคนหรือสัตว์ และอย่าจ้องมองลำแสงเลเซอร์แม้จะอยู่ในระยะไกล**

ปิดสวิตช์ เลเซอร์โดยกดปุ่มเปิด-ปิด-ลบ (9) [0] สั้นๆ

ปิดสวิตช์ กล้องถ่ายรูปโดยกดปุ่มช่อมองภาพ (10)

ปิดสวิตช์ เครื่องมือวัดโดยกดปุ่มเปิด-ปิด-ลบ (9) [0] ค้างไว้ เมื่อปิดสวิตช์เครื่องมือวัด ค่าที่เก็บไว้ในหน่วยความจำและค่าที่ตั้งไว้ในเครื่องจะยังคงอยู่

กล้องถ่ายรูป

เมื่อเปิดสวิตช์เครื่องมือวัดเป็นครั้งแรก กล้องถ่ายรูป (20) จะเปิดโดยอัตโนมัติ หากต้องการปิด โทคกดปุ่มช่อมองภาพ (10)

การตั้งค่าของกล้องถ่ายรูป (เปิด-ปิด) จะถูกเก็บไว้เมื่อปิดสวิทช์เครื่องมือวัด

การเพิ่มประสิทธิภาพการมองเห็นจุดเลเซอร์

เมื่อใช้เครื่องมือวัดโดยเฉพาะอย่างยิ่งในที่กลางแจ้ง ในที่มีแสงแดดจ้า และการวัดระยะทางไกลภายในอาคาร ท่านอาจมองไม่เห็นจุดเลเซอร์ นอกเหนือจากการเปิดกล้องถ่ายรูป ท่านยังสามารถปรับปรุงการมองเห็นจุดเลเซอร์/เป้าหมายวัดให้ดียิ่งขึ้นได้โดย:

- การตั้งค่าความสว่างของจอแสดงผล (การตั้งค่าอุปกรณ์)
- การซูมด้วยปุ่ม (5)

กระบวนการวัด

เมื่อเปิดสวิทช์ เครื่องมือวัดจะอยู่ในฟังก์ชันการวัดความยาวสำหรับฟังก์ชันการวัดอื่นๆ ใ้กดปุ่ม (13) [Func] เลือกฟังก์ชันการวัดที่ต้องการด้วยปุ่ม (4) [+] หรือปุ่ม (11) [-] จาก เรียกใช้งานฟังก์ชันการวัดด้วยปุ่ม (13) [Func] หรือปุ่มวัด (2) [▲]

เมื่อเปิดสวิทช์ ขอบหลังของเครื่องมือวัดจะถูกเลือกเป็นระนาบอ้างอิงสำหรับการวัด เมื่อต้องการเปลี่ยนระนาบอ้างอิง (ดู "การเลือกระนาบอ้างอิง (ดูภาพประกอบ A)", หน้า 43) วางเครื่องมือวัดที่จุดเริ่มต้นที่ต้องการวัด (ต. ย. เช่น ผนั่งห้อง)

หมายเหตุ: หากเปิดสวิทช์เครื่องมือวัดด้วยปุ่มเปิด-ปิด-ลบ (9) [0] ใ้กดปุ่มวัด (2) [▲] สั้นๆ เพื่อเปิดแสงเลเซอร์ กดปุ่มวัด (2) [▲] สั้นๆ เพื่อเริ่มต้นการวัด จากนั้นลำแสงเลเซอร์จะปิดลง สำหรับการวัดต่อไป ให้ทำซ้ำขั้นตอนนี้

เมื่อลำแสงเลเซอร์ต่อเนื่องเปิดสวิทช์และอยู่ในฟังก์ชันการวัดต่อเนื่อง การวัดจะเริ่มต้นทันทีเมื่อกดปุ่มวัด (2) [▲] ครั้งแรก

- ▶ **อย่าส่องลำแสงเลเซอร์ไปยังคนหรือสัตว์ และอย่าจ้องมองลำแสงเลเซอร์แม้จะอยู่ในระยะไกล**

หมายเหตุ: โดยทั่วไปค่าจากการวัดจะปรากฏภายใน 0.5 วินาที และ 4 วินาทีเป็นอย่างช้าที่สุด ระยะเวลาที่ใช้ในการวัดขึ้นอยู่กับระยะทาง สภาพแสง และคุณสมบัติการสะท้อนของพื้นผิวเป้าหมาย เมื่อเสร็จสิ้นการวัด ลำแสงเลเซอร์จะปิดโดยอัตโนมัติ ลำแสงเลเซอร์ต่อเนื่องที่เปิดสวิทช์อยู่จะไม่ปิดสวิทช์หลังการวัด

การเลือกระนาบอ้างอิง (ดูภาพประกอบ A)

สำหรับการวัด ท่านสามารถเลือกระนาบอ้างอิงได้สี่ลักษณะ:

- ขอบหลังของเครื่องมือวัด (ต. ย. เช่น เมื่อวางบนผนังห้อง)
- ตรงปลายที่กางออก 180° ของหมุดวัด (8) (ต. ย. เช่น สำหรับการวัดจากมุม)

- ขอบหน้าของเครื่องมือวัด (ต. ย. เช่น เมื่อวัดจากขอบโต๊ะ เป็นต้นไป)

- จุดศูนย์กลางเกลียว (17) (ต. ย. เช่น สำหรับการวัดด้วยขาตั้งแบบสามขา)

การเปิดและปิดหมุดวัด (8) ไป 180° จะถูกตรวจพบโดยอัตโนมัติ และจะแนะนำระนาบอ้างอิงที่เหมาะสม ยืนยันการตั้งค่าด้วยปุ่มวัด (2) [▲]

เลือกการตั้งค่าของเครื่องมือวัดด้วยซอฟต์แวร์ (3) [■] เลือกระนาบอ้างอิงด้วยปุ่ม (4) [+] หรือปุ่ม (11) [-] และยืนยันด้วยปุ่ม (13) [Func]

ทุกครั้งเมื่อเปิดสวิทช์เครื่องมือวัด ขอบหลังของเครื่องมือวัดจะถูกตั้งเป็นระนาบอ้างอิงโดยอัตโนมัติ

ลำแสงเลเซอร์ต่อเนื่อง

ท่านสามารถเปลี่ยนเครื่องมือวัดมาเป็นแบบลำแสงเลเซอร์ต่อเนื่องได้หากจำเป็น สำหรับการเปลี่ยน เลือกการตั้งค่าของเครื่องมือวัดด้วยซอฟต์แวร์ (3) [■] เลือกลำแสงเลเซอร์ต่อเนื่องด้วยปุ่ม (4) [+] หรือปุ่ม (11) [-] และยืนยันด้วยปุ่ม (13) [Func]

- ▶ **อย่าส่องลำแสงเลเซอร์ไปยังคนหรือสัตว์ และอย่าจ้องมองลำแสงเลเซอร์แม้จะอยู่ในระยะไกล**

ในการตั้งค่านี้ลำแสงเลเซอร์จะยังคงเปิดอยู่ในระหว่างการวัด เมื่อต้องการวัด ใ้กดปุ่มวัด (2) [▲] สั้นๆ เพียงครั้งเดียว ปิดสวิทช์ลำแสงเลเซอร์ต่อเนื่องในการตั้งค่านี้เช่นกัน หรือโดยอัตโนมัติเมื่อปิดสวิทช์เครื่องมือวัดในการตั้งค่านี้เช่นกัน หรือโดยอัตโนมัติเมื่อปิดสวิทช์เครื่องมือวัด

เมนู "การตั้งค่า"

เมื่อต้องการเข้าสู่เมนู "การตั้งค่า" (i) ใ้กดซอฟต์แวร์ (3) [■] สั้นๆ หรือกดปุ่ม (13) [Func] ค้างไว้

เลือกการตั้งค่าที่ต้องการด้วยปุ่ม (4) [+] หรือปุ่ม (11) [-] และยืนยันด้วยปุ่ม (13) [Func] เลือกการตั้งค่าที่ต้องการเมื่อต้องการออกจากเมนู "การตั้งค่า" ใ้กดปุ่มเปิด-ปิด-ลบ (9) [0] หรือซอฟต์แวร์ (12) [■]

การตั้งค่า

✱	Bluetooth®
☰	ระนาบอ้างอิง
⌚	ฟังก์ชันจับเวลา
☀	ลำแสงเลเซอร์ต่อเนื่อง
☐ CAL	การสอบเทียบ การวัดความลาดชัน
☐ CAL	การสอบเทียบ ช่องมองภาพ

การตั้งค่า



การตั้งค่าอุปกรณ์

ฟังก์ชันจับเวลา

ฟังก์ชันจับเวลามีประโยชน์ ต. ย. เช่น เมื่อวัดตรงตำแหน่งที่ยากจะเข้าถึง หรือเมื่อไม่สามารถเคลื่อนที่เครื่องมือวัดระหว่างการวัด

เลือกฟังก์ชันจับเวลาในการตั้งค่า เลือกช่วงเวลาจากการกระตุ้นจนกระทั่งเกิดการวัดที่ต้องการ และยืนยันด้วยปุ่มวัด (2) [▲] หรือปุ่ม (13) [Func]

จากนั้นจึงกดปุ่มวัด (2) [▲] เพื่อเปิดลำแสงเลเซอร์ และเล็งไปที่จุดเป้าหมาย กดปุ่มวัด (2) [▲] อีกครั้งเพื่อเริ่มต้นการวัด การวัดเกิดขึ้นหลังจากช่วงเวลาที่คุณเลือกไว้ ค่าจากการวัดจะแสดงในบรรทัดผลลัพธ์ (a)

ในแถบสถานะด้านบนจะแสดงช่วงเวลาจากการกระตุ้นจนกระทั่งเกิดการวัด

การวัดอย่างต่อเนื่อง รวมทั้งการวัดค่าต่ำสุด/สูงสุด ไม่สามารถทำได้เมื่อตั้งฟังก์ชันจับเวลาไว้

ตัวจับเวลาจะยังคงถูกตั้งไว้จนกว่าจะปิดสวิตช์เครื่องมือวัด หรือนกว่าจะปิดสวิตช์ตัวจับเวลาในเมนู “การตั้งค่า”

เมนู “การตั้งค่าอุปกรณ์”

เลือกเมนู “การตั้งค่าอุปกรณ์” ในเมนู “การตั้งค่า”

เลือกการตั้งค่าอุปกรณ์ที่ต้องการด้วยปุ่ม (4) [+] หรือปุ่ม (11) [-] และยืนยันด้วยปุ่ม (13) [Func] เลือกการตั้งค่าอุปกรณ์ที่ต้องการ

เมื่อต้องการออกจากเมนู “การตั้งค่าอุปกรณ์” (o) ให้กดปุ่มเปิด-ปิด-ลบ (9) [0] หรือชอฟต์คีย์ (12) [▼]

การตั้งค่าอุปกรณ์



	ภาษา
	เวลา & วันที่
	หน่วยของการวัด
	หน่วยของมุม
	TrackMyTools
	ข้อมูลอุปกรณ์
	สัญญาณเสียง
	เวลาปิดสวิตช์
	ติ่มเมอร์
	จอแสดงผล-ความสว่าง
	จอแสดงผล-การจัดให้ถูกตำแหน่ง

การกำหนดภาษา

เลือก “ภาษา” ในการตั้งค่าอุปกรณ์ กำหนดภาษาที่ต้องการและยืนยันด้วยปุ่ม (13) [Func] หรือปุ่มวัด (2) [▲]

การตั้งค่าวันที่และเวลา

เลือก “เวลา & วันที่” ในการตั้งค่าอุปกรณ์ ตั้งค่าวันที่และเวลาตามคำแนะนำบนหน้าจอ และยืนยันด้วยชอฟต์คีย์ (12) [▼]

หมายเหตุ: ต้องตั้งวันที่และเวลาอีกครั้งหลังจากเปลี่ยนแบตเตอรี่

การเปลี่ยนหน่วยของการวัด

เลือก “หน่วยของการวัด” ในการตั้งค่าอุปกรณ์ ค่าเริ่มต้นคือหน่วยของการวัด “ม.” (เมตร)

ตั้งค่าหน่วยของการวัดที่ต้องการ และยืนยันด้วยปุ่ม (13) [Func]

เมื่อต้องการออกจากรายการเมนู ให้กดปุ่มเปิด-ปิด-ลบ (9) [0] หรือชอฟต์คีย์ (3) [▶] การตั้งค่าอุปกรณ์ที่เลือกจะถูกเก็บไว้เมื่อปิดสวิตช์เครื่องมือวัด

การเปลี่ยนหน่วยของมุม

เลือก “หน่วยของมุม” ในการตั้งค่าอุปกรณ์ ค่าเริ่มต้นคือหน่วยของมุมคือ “o” (องศา)

ตั้งค่าหน่วยของมุมที่ต้องการ และยืนยันด้วยปุ่ม (13) [Func]

เมื่อต้องการออกจากรายการเมนู ให้กดปุ่มเปิด-ปิด-ลบ (9) [0] หรือชอฟต์คีย์ (3) [▶] การตั้งค่าอุปกรณ์ที่เลือกจะถูกเก็บไว้เมื่อปิดสวิตช์เครื่องมือวัด

TrackMyTools

เลือก “TrackMyTools” ในการตั้งค่าอุปกรณ์ ยืนยันการตั้งค่าด้วยปุ่ม (13) [Func]

จำเป็นต้องทำการเรียกใช้งานครั้งแรก การถ่ายโอนข้อมูลทำได้เฉพาะเมื่อใช้ App ที่เกี่ยวข้องหรือโปรแกรมคอมพิวเตอร์ที่เกี่ยวข้องเท่านั้น

สามารถปิดการใช้งาน TrackMyTools ได้ตลอดเวลา การตั้งค่าของ TrackMyTools (เรียกใช้งาน/ปิดใช้งาน) จะถูกเก็บไว้เมื่อปิดสวิตช์เครื่องมือวัด

หมายเหตุ: TrackMyTools ทำงานเฉพาะเมื่อมีแบตเตอรี่ใส่อยู่เท่านั้น หากต้องการเรียกใช้งาน TrackMyTools หลังจากเปลี่ยนแบตเตอรี่ ต้องเปิดสวิตช์เครื่องมือวัดสั้นๆ

การส่องสว่างหน้าจอแสดงผล

เลือก “ติ่มเมอร์” ในการตั้งค่าอุปกรณ์

แสงสว่างหน้าจอแสดงผลจะติดขึ้นอย่างต่อเนื่อง หากไม่มีการกดปุ่มใดๆ ภายในเวลาประมาณ 30 วินาที แสงสว่างหน้าจอแสดงผลจะหรี่ลงเพื่อประหยัดแบตเตอรี่

สามารถปรับช่วงเวลาถึงการเริ่มต้นการหรือความสว่างได้ (การตั้งค่าอุปกรณ์)

ท่านสามารถปรับความสว่างของจอแสดงผลตามสภาพแวดล้อมได้หลายขั้น (การตั้งค่าอุปกรณ์)

ฟังก์ชันการวัด

หมายเหตุ: ฟังก์ชันความช่วยเหลือนัดเสร็จ

ความช่วยเหลือนัดเป็นภาพเคลื่อนไหวจะอยู่ในทุกๆ ฟังก์ชันการวัดในเครื่องมือวัด เมื่อต้องการเรียกใช้ ให้เลือกปุ่ม (13) [Func] ปุ่ม (4) [+] หรือ (11) [-] และจากนั้นซอฟต์แวร์จะ (3) [] ภาพเคลื่อนไหวแสดงขั้นตอนโดยละเอียดเกี่ยวกับฟังก์ชันการวัดที่เลือก

สามารถหยุดภาพเคลื่อนไหวและเริ่มต้นใหม่ได้ตลอดเวลาด้วย (3) [] ท่านสามารถเลื่อนไปข้างหน้าและย้อนกลับได้ด้วยปุ่ม (4) [+] หรือ (11) [-]

การวัดความยาว

เลือกการวัดความยาว \rightarrow

เมื่อต้องการเปิดลำแสงเลเซอร์ ให้กดปุ่มวัด (2) [▲] สั้นๆ กดปุ่มวัด (2) [▲] สั้นๆ เพื่อทำการวัด ค่าจากการวัดแสดงอยู่ที่ด้านล่างของจอแสดงผล

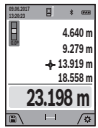

สำหรับการวัดเพิ่มเติมแต่ละครั้ง ให้ทำซ้ำขั้นตอนข้างต้น ค่าจากการวัดครั้งล่าสุดแสดงที่ด้านล่างของจอแสดงผล ค่าจากการวัดก่อนครั้งล่าสุดแสดงที่ด้านบน ฯลฯ

การวัดต่อเนื่อง

สำหรับการวัดต่อเนื่อง ท่านสามารถเคลื่อนย้ายเครื่องมือวัดเทียบกับเป้าหมายโดยที่ค่าจากการวัดจะได้รับการปรับปรุงทุกๆ 0.5 วินาที ต. ย. เช่น ท่านสามารถเดินออกจากผนังไปยังระยะห่างที่ต้องการในขณะที่สามารถอ่านระยะทางจริงได้เสมอ

เลือกการวัดต่อเนื่อง \rightarrow

เมื่อต้องการเปิดลำแสงเลเซอร์ ให้กดปุ่มวัด (2) [▲] สั้นๆ เลื่อนเครื่องมือวัดจนกระทั่งค่าระยะที่ต้องการแสดงที่ด้านล่างของจอแสดงผล

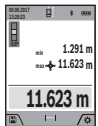

กดปุ่มวัด (2) [▲] สั้นๆ เพื่อหยุดการวัดต่อเนื่อง ค่าจากการวัดปัจจุบันแสดงที่ด้านล่างของจอแสดงผล ค่าจากการวัดสูงสุดและต่ำสุดแสดงที่ด้านบน กดปุ่มวัด (2) [▲] อีกครั้ง เพื่อเริ่มต้นการวัดต่อเนื่องใหม่

การวัดต่อเนื่องจะปิดสวิตช์โดยอัตโนมัติหลังจากผ่านไป 5 นาที

การวัดพื้นที่

เลือกการวัดพื้นที่

หลังจากนั้นให้วัดความยาวและความกว้างตามลำดับในลักษณะเดียวกับการวัดความยาว ลำแสงเลเซอร์ยังคงเปิดอยู่ระหว่างการวัดทั้งสองครั้ง ระยะทางที่จะวัดจะกะพริบในจอแสดงผลสำหรับการวัดพื้นที่ (ดู ส่วนประกอบจอแสดงผล (j))

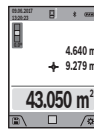

ค่าจากการวัดค่าแรกแสดงที่ด้านบนของจอแสดงผล

เมื่อการวัดค่าที่สองเสร็จสมบูรณ์ พื้นที่ผิว

จะถูกคำนวณโดยอัตโนมัติและแสดงผล

ผลลัพธ์สุดท้ายแสดงที่ด้านล่างของจอแสดงผล

ค่าจากการวัดแต่ละค่าแสดงที่ด้านบน

การวัดปริมาตร

เลือกการวัดปริมาตร

หลังจากนั้นให้วัดความกว้าง ความยาว และความลึกตามลำดับในลักษณะเดียวกับการวัดความยาว ลำแสงเลเซอร์ยังคงเปิดอยู่ระหว่างการวัดทั้งสามครั้ง ระยะทางที่จะวัดจะกะพริบในจอแสดงผลสำหรับการวัดปริมาตร (ดู ส่วนประกอบจอแสดงผล (j))

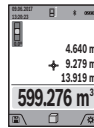

ค่าจากการวัดค่าแรกแสดงที่ด้านบนของจอแสดงผล

เมื่อการวัดค่าที่สามเสร็จสมบูรณ์

ปริมาตรจะถูกคำนวณโดยอัตโนมัติและแสดงผล

ผลลัพธ์สุดท้ายแสดงที่ด้านล่างของจอแสดงผล

ค่าจากการวัดแต่ละค่าแสดงที่ด้านบน

การวัดระยะทางทางอ้อม

เลือกการวัดระยะทางทางอ้อม \rightarrow สำหรับการวัดระยะทางทางอ้อม มีฟังก์ชันการวัดสี่รูปแบบ และสามารถใช้แต่ละฟังก์ชันการวัดสำหรับกำหนดระยะทางที่แตกต่างกันได้

การวัดระยะทางทางอ้อมใช้วัดระยะทางที่ไม่สามารถวัดได้โดยตรง เพราะมีสิ่งกีดขวางที่อาจขวางลำแสงเลเซอร์หรือไม่มีความหมายที่เป็นตัวสะท้อนแสง กระบวนการวัดนี้สามารถใช้ได้เฉพาะในทิศทางแนวตั้งเท่านั้น การเบี่ยงเบนใดๆ ในแนวนอนนำไปสู่ความผิดพลาดในการวัด

หมายเหตุ: การวัดระยะทางทางอ้อมจะแม่นยำน้อยกว่าการวัดระยะทางตรงเสมอ ข้อผิดพลาดในการวัดอาจมีมากกว่าการวัดระยะทางตรงทั้งนี้ขึ้นอยู่กับการใช้งาน เพื่อปรับปรุงความแม่นยำการวัด เราขอแนะนำให้เลือกใช้ขาตั้งแบบสามขา (อุปกรณ์ประกอบ) ระหว่างการวัดแต่ละครั้ง ลำแสงเลเซอร์ยังคงเปิดอยู่

ก) การวัดความสูงทางอ้อม (ดูภาพประกอบ B)

เลือกการวัดความสูงทางอ้อม \rightarrow

ตรวจสอบให้แน่ใจว่าเครื่องมือวัดวางอยู่บนแนวเดียวกับจุดวัดด้านล่าง จากนั้นให้เอียงเครื่องมือวัดรอบระนาบอ้างอิงและวัดระยะทาง "1" ในลักษณะเดียวกับการวัดความยาว (บนจอแสดงผลปรากฏเป็นเส้นสีแดง)

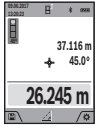

เมื่อการวัดเสร็จสมบูรณ์ ผลลัพธ์สำหรับระยะทางที่ต้องการหา "X" จะแสดงในบรรทัดผลลัพธ์ (a) ค่าจากการวัดสำหรับระยะทาง "1" และมุม "α" จะแสดงในบรรทัดแสดงค่าจากการวัด (h)

ข) การวัดความสูงทางอ้อมแบบสองครั้ง (รูปภาพประกอบ C)

เครื่องมือวัดสามารถวัดระยะทางที่อยู่ในระนาบแนวตั้งของเครื่องมือวัดโดยทางอ้อมได้ทั้งหมด เลือกการวัดความสูงทางอ้อมแบบสองครั้ง < วัตรระยะทาง "1" และ "2" ตามลำดับในลักษณะเดียวกับการวัดความยาว

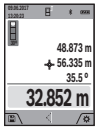

เมื่อการวัดค่าเสร็จสมบูรณ์ ผลลัพธ์สำหรับระยะทางที่ต้องการหา "X" จะแสดงในบรรทัดผลลัพธ์ (a) ค่าจากการวัดสำหรับระยะทาง "1", "2" และมุม "α" จะแสดงในบรรทัดแสดงค่าจากการวัด (h)

ตรวจสอบให้แน่ใจว่าระนาบอ้างอิงของการวัด (ต. ย. เช่น ขอบหลังของเครื่องมือวัด) ยังคงอยู่ที่ตำแหน่งเดียวกันอย่างพอดีพอดีสำหรับการวัดแต่ละครั้งทั้งหมดในกระบวนการวัด

ค) การวัดความยาวทางอ้อม (รูปภาพประกอบ D)

การวัดความยาวทางอ้อม

ตรวจสอบให้แน่ใจว่าเครื่องมือวัดวางอยู่ที่ความสูงเดียวกับจุดวัดที่ต้องการหา จากนั้นให้เอียงเครื่องมือวัดรอบระนาบอ้างอิงและวัดระยะทาง "1" ในลักษณะเดียวกับการวัดความยาว

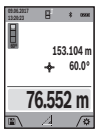

เมื่อการวัดค่าเสร็จสมบูรณ์ ผลลัพธ์สำหรับระยะทางที่ต้องการหา "X" จะแสดงในบรรทัดผลลัพธ์ (a) ค่าจากการวัดสำหรับระยะทาง "1" และมุม "α" จะแสดงในบรรทัดแสดงค่าจากการวัด (h)

ง) การวัดรูปสี่เหลี่ยมคางหมู (รูปภาพประกอบ E)

ท่านสามารถใช้การวัดรูปสี่เหลี่ยมคางหมูเพื่อกำหนดความยาวของความลาดชันของหลังคา เป็นต้น

เลือกการวัดรูปสี่เหลี่ยมคางหมู

วัตรระยะทาง "1", "2" และ "3" ตามลำดับในลักษณะเดียวกับการวัดความยาว ตรวจสอบให้แน่ใจว่าการวัดระยะทาง "3" เริ่มต้นที่จุดปลายของระยะทาง "1" อย่างพอดีพอดี

และให้มุมระหว่างระยะ "1" และ "2" และระหว่าง "1" และ "3" เป็นมุมฉาก

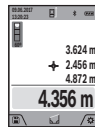

เมื่อการวัดค่าครั้งสุดท้ายเสร็จสมบูรณ์ ผลลัพธ์ของระยะทางที่ต้องการหา "X" จะแสดงในบรรทัดผลลัพธ์ (a) ค่าจากการวัดแต่ละครั้งจะแสดงในบรรทัดแสดงค่าจากการวัด (h)

การวัดพื้นผิวผนัง (รูปภาพประกอบ F)

การวัดพื้นผิวผนังใช้สำหรับคำนวณผลรวมของพื้นผิวแต่ละด้านหลายๆ พื้นผิวที่มีความสูงเท่ากัน ในตัวอย่างที่แสดงเราต้องการหาพื้นผิวทั้งหมดของผนังหลายด้านที่มีความสูงของ H เท่ากัน แต่ความยาว L ต่างกัน

เลือกการวัดพื้นผิวผนัง

วัดความสูงของ H ในลักษณะเดียวกับการวัดความยาว ค่าจากการวัดแสดงในบรรทัดบนของบรรทัดแสดงค่าจากการวัด เลเซอร์ยังคงเปิดอยู่

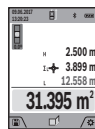

จากนั้นให้วัดความยาว L₁ ของผนังแรก พื้นผิวจะถูกคำนวณโดยอัตโนมัติและแสดงในบรรทัดผลลัพธ์ (a) ค่าความยาวจากการวัดครั้งล่าสุดแสดงในบรรทัดล่างของบรรทัดแสดงค่าจากการวัด (h) เลเซอร์ยังคงเปิดอยู่

ต่อไปให้วัดความยาว L₂ ของผนังที่สอง ค่าการวัดแต่ละครั้งก็แสดงในบรรทัดแสดงค่าจากการวัด (h) จะรวมกับความยาว L₁ ผลรวมของความยาวทั้งสอง (แสดงในบรรทัดกลางของบรรทัดแสดงค่าจากการวัด (h)) จะคูณกับความสูงที่เก็บไว้ H ค่าพื้นผิวทั้งหมดจะแสดงในบรรทัดผลลัพธ์ (a)

ท่านสามารถวัดความยาว L_x อื่นๆ อีกมากมาย ซึ่งความยาวจะถูกนำมารวมกันโดยอัตโนมัติ แล้วนำมาคูณกับความสูง H เงื่อนไขเบื้องต้นสำหรับการคำนวณพื้นที่อย่างถูกต้องคือความยาวที่วัดครั้งแรก (ในตัวอย่างคือความสูงของ H) ต้องเท่ากันในทุกๆ ด้าน

ฟังก์ชันการกำหนดเขต (รูปภาพประกอบ G)

ฟังก์ชันการกำหนดเขตจะวัดซ้ำความยาวที่กำหนดไว้แล้ว (ระยะทาง) ความยาวนี้สามารถถอยทอดลงบนพื้นผิว ต. ย. เช่น เพื่อจะได้ติดตั้งคู่มือใหม่มีความยาวเท่าๆ กัน หรือติดตั้งผนังระบบโครงคร่าวในดราวยอลล์ ความยาวต่ำสุดที่สามารถปรับได้คือ 0.1 ม. ความยาวสูงสุดคือ 50 ม.

หมายเหตุ: ในฟังก์ชันการกำหนดเขต ระยะห่างจากเครื่องหมายจะแสดงในจอแสดงผล จุดอ้างอิงไม่ใช่ขอบของเครื่องมือวัด

เลือกฟังก์ชันการกำหนดเขต

กำหนดความยาวที่ต้องการด้วยปุ่ม (4) [+] หรือปุ่ม (11) [-]

เริ่มต้นฟังก์ชันการกำหนดเขตโดยกดปุ่ม (2) [▲] แล้วลอยออกจากจุดเริ่มต้นอย่างช้าๆ



เครื่องมือวัดจะวัดระยะทางจากจุดเริ่มต้นอย่างต่อเนื่อง ความยาวที่กำหนดไว้รวมทั้งค่าจากการวัดปัจจุบันจะปรากฏขึ้น ลูกศรบนและล่างแสดงให้เห็นระยะทางที่สั้นที่สุดไปยัง

เครื่องหมายถัดไปหรือก่อนหน้า

หมายเหตุ: เมื่อวัดอย่างต่อเนื่อง ท่านสามารถตั้งค่าที่วัดได้เป็นความยาวที่กำหนดโดยกดปุ่มวัด (2) [▲] และกดค้างไว้



ตัวคูณทางด้านซ้ายระบุจำนวนครั้งที่ถึงความยาวที่กำหนดแล้ว ลูกศรสีเขียวที่ด้านข้างของจอแสดงผลจะปรากฏมาถึงความยาวเพื่อให้ท่านทำเครื่องหมาย

ลูกศรสีแดงหรือป้ายสีแดงบ่งบอกค่าที่แท้จริง หากค่าอ้างอิงอยู่บนจอแสดงผล

การวัดความลาดชัน/ระดับน้ำดิจิทัล

เลือกการวัดความลาดชัน/ระดับน้ำดิจิทัล

เครื่องมือวัดสลับไปมาระหว่างสองสถานะโดยอัตโนมัติ

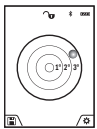

ระดับน้ำดิจิทัลใช้สำหรับตรวจสอบการปรับระนาบแนวนอนหรือแนวตั้งของสิ่งของ (ต. ย. เช่น เครื่องซักรีด ตู้เย็น ฯลฯ)

ถ้ามีความลาดชันเกินกว่า 3° ลูกกลมบนจอแสดงผลจะส่องสว่างสีแดง

ระนาบอ้างอิงสำหรับระดับน้ำดิจิทัลคือด้านล่างของเครื่องมือวัด

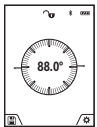

การวัดความลาดชันใช้สำหรับวัดความเอียงหรือความชัน (ต. ย. เช่น ของบันได ราวบันได สำหรับปรับเฟอร์นิเจอร์ให้เหมาะสม สำหรับติดตั้งท่อ ฯลฯ)

ระนาบอ้างอิงสำหรับสำหรับการวัดความลาดชันคือด้านซ้ายของเครื่องมือวัด หากสัญลักษณ์กะพริบในระหว่างกระบวนการวัด แสดงว่าเครื่องมือวัดเอียงไปทางด้านข้างมากเกินไป

ฟังก์ชันหน่วยความจำ

ค่าและผลลัพธ์สุดท้ายของการวัดแต่ละครั้งที่เสร็จสมบูรณ์จะถูกเก็บไว้โดยอัตโนมัติ

การแสดงค่าในหน่วยความจำ

สามารถเรียกดูได้สูงสุด 50 ค่า (ค่าจากการวัดหรือภาพถ่ายที่มีค่าจากการวัด)

เลือกฟังก์ชันหน่วยความจำด้วยซอฟต์แวร์ (12) [■]

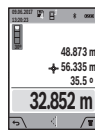

จำนวนของค่าในหน่วยความจำจะปรากฏที่ด้านบนของจอแสดงผล ค่าในหน่วยความจำที่สอดคล้องกันและฟังก์ชันการวัดที่สอดคล้องกันจะปรากฏที่ด้านล่าง

กดปุ่ม (4) [+] เพื่อเลื่อนดูค่าที่เก็บไว้ไปยัง

หน้า

กดปุ่ม (11) [-] เพื่อเลื่อนดูค่าที่เก็บไว้ย้อนหลัง

หากไม่มีค่าในหน่วยความจำ "0.000" จะแสดงในบรรทัดล่างของจอแสดงผล "0" ในบรรทัดบน

ค่าเก่าที่สุดจะอยู่ที่ตำแหน่งที่ 1 ในหน่วยความจำ ค่าล่าสุดอยู่ในตำแหน่งที่ 50 (สำหรับค่าในหน่วยความจำ 50 ค่าที่มีอยู่) เมื่อมีการเก็บค่าต่อไป ค่าเก่าที่สุดจะถูกลบออกจากหน่วยความจำเสมอ

การลบหน่วยความจำ

เมื่อต้องการเปิดหน่วยความจำ ให้กดซอฟต์แวร์ (12) [■] เมื่อต้องการลบค่าจากการวัดตามลำดับย้อนกลับให้กดซอฟต์แวร์ (3) [■] หลายๆ ครั้งตามต้องการเมื่อต้องการลบเนื้อหาหน่วยความจำทั้งหมด ให้กดซอฟต์แวร์ (3) [■] และปุ่มซุ่ม (5) พร้อมกัน

การเพิ่ม/การลดค่า

ท่านสามารถเพิ่มหรือลดค่าจากการวัดหรือผลลัพธ์สุดท้ายได้

การเพิ่มค่า

ตัวอย่างต่อไปนี้อธิบายการเพิ่มค่าของพื้นที่: วัดพื้นที่ตามที่อธิบายไว้ในบท "การวัดพื้นที่" (ดู "การวัดพื้นที่", หน้า 45)

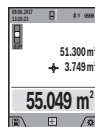

กดปุ่ม (4) [+] พื้นที่ที่คำนวณได้และสัญลักษณ์ "+" จะปรากฏขึ้น กดปุ่มวัด (2) [▲] เพื่อเริ่มต้นวัดพื้นที่อื่นๆ ต่อไป วัดพื้นที่ตามที่อธิบายไว้ในบท "การวัดพื้นที่" (ดู "การวัดพื้นที่", หน้า 45) พื้นที่ที่การวัดที่สองเสร็จสมบูรณ์

ผลลัพธ์ของการวัดพื้นที่ที่สองแสดงที่ด้านล่างของจอแสดงผล เมื่อต้องการดูผลลัพธ์สุดท้าย ให้กดปุ่มวัด (2) [▲] อีกครั้ง

หมายเหตุ: สำหรับการวัดความยาว ผลลัพธ์สุดท้ายจะปรากฏทันที

การลดค่า

เมื่อต้องการลดค่า ให้กดปุ่ม (11) [-] ซ้ำตอนต่อไปจะเหมือนกับ "การเพิ่มค่า"

การลบทิ้งค่าจากการวัด

เมื่อกดปุ่มเปิด-ปิด-ลบ (9) [0] ล้วนๆ ท่านสามารถลบค่าจากการวัดครั้งล่าสุดในทุกฟังก์ชันการวัด

Bluetooth®-อินเตอร์เฟส

การถ่ายทอดข้อมูลไปยังอุปกรณ์อื่น

เครื่องมือวัดนี้ติดตั้งโมดูล Bluetooth® ที่ช่วยถ่ายทอดข้อมูลด้วยเทคโนโลยีคลื่นวิทยุสำหรับเชื่อมโยงสื่อสารแบบไร้สายไปยังอุปกรณ์เคลื่อนที่ปลายทางบางอย่างที่มี Bluetooth®-อินเตอร์เฟส (ต. ย. เช่น สมาร์ทโฟน แท็บเล็ต) กรุณาค้นหาข้อมูลเกี่ยวกับความต้องการของระบบที่จำเป็นสำหรับการเชื่อมต่อ Bluetooth® ได้ที่เว็บไซต์ของ บอช www.bosch-pt.com

► สำหรับข้อมูลเพิ่มเติม กรุณาดูหน้าผลิตภัณฑ์ของ บอช ในระหว่างการถ่ายทอดข้อมูลผ่านทาง Bluetooth® อาจเกิดความล่าช้าในการแปรสัญญาณระหว่างอุปกรณ์เคลื่อนที่ปลายทางและเครื่องมือวัด ทั้งนี้ขึ้นอยู่กับระยะห่างระหว่างอุปกรณ์ที่สื่อสารข้อมูลกันหรือวัตถุที่จะวัด

การเรียกใช้งาน Bluetooth®-อินเตอร์เฟสเพื่อถ่ายทอดข้อมูลไปยังอุปกรณ์เคลื่อนที่ปลายทาง

เรียกใช้งาน Bluetooth®-อินเตอร์เฟสในการตั้งค่า เมื่อต้องการเรียกใช้งานสัญญาณ Bluetooth® ให้กดปุ่ม (4) [+] ตรวจสอบให้แน่ใจว่า Bluetooth®-อินเตอร์เฟสที่อุปกรณ์เคลื่อนที่ปลายทางของท่านถูกเรียกใช้งาน เพื่อขยายขอบเขตการทำงานของอุปกรณ์เคลื่อนที่ปลายทางและเพื่อประมวลผลข้อมูลให้สูงขึ้น เรามี Bosch แอปพลิเคชัน (App) พิเศษ "Measuring Master" สำหรับใช้งานท่านสามารถดาวน์โหลดแอปพลิเคชันเหล่านี้ตามประเภทอุปกรณ์ปลายทางได้จากแหล่งรวมแอปพลิเคชันที่เกี่ยวข้อง เมื่อเริ่มต้น Bosch แอปพลิเคชัน การเชื่อมต่อระหว่างอุปกรณ์เคลื่อนที่ปลายทางและเครื่องมือวัดจะเกิดขึ้น ถ้าพบเครื่องมือวัดที่ทำงานอยู่หลายเครื่อง ให้เลือกเครื่องมือวัดที่เหมาะสมโดยดูจากหมายเลขเครื่อง ท่านสามารถค้นหาหมายเลขเครื่อง (15) จากแผ่นป้ายรุ่นของเครื่องมือวัดของท่าน

สถานะการเชื่อมต่อและการเชื่อมต่อที่ใช้งานอยู่ (f) จะปรากฏบนจอแสดงผล (1) ของเครื่องมือวัด

การปิดการเรียกใช้งาน Bluetooth®-อินเตอร์เฟส

ปิดการใช้งานการเชื่อมต่อ Bluetooth® ในการตั้งค่า เมื่อต้องการปิดการใช้งานสัญญาณ Bluetooth® ให้กดปุ่ม (11) [-] หรือปิดสวิตช์เครื่องมือวัด

ข้อแนะนำในการทำงาน

► สำหรับข้อมูลเพิ่มเติม กรุณาดูหน้าผลิตภัณฑ์ของ บอช

► เครื่องมือวัดมีอินเตอร์เฟสคลื่นวิทยุสำหรับเชื่อมโยงสื่อสารแบบไร้สาย ต้องปฏิบัติตามข้อจำกัดการทำงานในพื้นที่ ต. ย. เช่น ในเครื่องมือบิน หรือโรงพยาบาล

ข้อแนะนำทั่วไป

เลนส์รับแสง (18) ช่องทางออกลำแสงเลเซอร์ (19) และกล้องถ่ายรูป (20) ต้องไม่ถูกปิดคลุมขณะทำการวัด ต้องไม่เคลื่อนย้ายเครื่องมือวัดในระหว่างทำการวัด ดังนั้นให้วางเครื่องมือวัดลงบนพื้นผิวรองรับหรือทาบกับผนังหยุดที่แข็งแรงเท่าที่เป็นไปได้

ปัจจัยที่ส่งผลกระทบต่อช่วงการวัด

ช่วงการวัดขึ้นอยู่กับสภาพแสงและคุณสมบัติการสะท้อนของพื้นผิวเป้าหมาย ใช้กล้องถ่ายรูปเม็ดเสร็จ (20) แวนตาสำหรับมองแสงเลเซอร์ (26) (อุปกรณ์ประกอบ) และแผ่นเป้าหมายเลเซอร์ (25) (อุปกรณ์ประกอบ) หรือให้ร่มเงาพื้นผิวเป้าหมายเพื่อจะดูมองเห็นลำแสงเลเซอร์ได้ดียิ่งขึ้นเมื่อแสงลอมรอบจามาก

ปัจจัยที่ส่งผลกระทบต่อผลลัพธ์การวัด

เนื่องจากผลทางกายภาพ การวัดอาจมีความผิดพลาดได้เมื่อวัดบนพื้นผิวที่แตกต่างกัน สิ่งเหล่านี้รวมถึง:

- พื้นผิวที่โปร่งแสง (ต. ย. เช่น แก้ว น้ำ)
- พื้นผิวที่สะท้อนแสง (ต. ย. เช่น โลหะขัดมัน กระดาษ)
- พื้นผิวที่มีรูพรุน (ต. ย. เช่น วัสดุฉนวน)
- พื้นผิวโครงสร้าง (ต. ย. เช่น ปูนฉาบ หินธรรมชาติ)

ให้ใช้แผ่นเป้าหมายเลเซอร์ (25) (อุปกรณ์ประกอบ) บนพื้นผิวเหล่านี้ หากจำเป็น

นอกจากนี้ความผิดพลาดจากการวัดอาจเกิดขึ้นได้เมื่อส่องพื้นผิวเป้าหมายที่อยู่ใต้อา่งเงา

ชั้นของอากาศที่มีอุณหภูมิแตกต่างกัน หรือแสงสะท้อนที่ได้รับทางอ้อม อาจส่งผลกระทบต่อค่าการวัดด้วยเช่นกัน

การตรวจสอบความแม่นยำและการสอบเทียบของ การวัดความลาดชัน (ดูภาพประกอบ H)

ตรวจสอบความแม่นยำของการวัดความลาดชันเป็นประจำ ซึ่งจะกระทำได้โดยการวัดกลับด้าน สำหรับการตรวจสอบ ให้วางเครื่องมือวัดบนโต๊ะและวัดความลาดชัน หมุนเครื่องมือวัดไป 180° และวัดความลาดชันอีกครั้งหนึ่ง ความแตกต่างของจำนวนเลขที่แสดงต้องไม่มากกว่า 0.3° (สูงสุด)

ในกรณีที่มีส่วนเบี่ยงเบนมากกว่า จะต้องสอบเทียบเครื่องมือวัดใหม่ เลือก $\frac{1}{10}$ ในการตั้งค่า ทำตามคำแนะนำบนจอแสดงผล

เมื่ออุณหภูมิมีการเปลี่ยนแปลงมากและเครื่องมือวัดถูกกระแทก เราขอแนะนำให้ตรวจสอบความแม่นยำ และหาก

จำเป็นให้สอบเทียบเครื่องมือวัด เมื่อ
อุณหภูมิมีการเปลี่ยนแปลงมาก ต้องปล่อยให้เครื่อง
มือวัดปรับเข้ากับอุณหภูมิรอบด้านสักชั่วครู่ก่อนสอบเทียบ

การตรวจสอบความแม่นยำของการวัดระยะทาง

ความแม่นยำของเครื่องมือวัดสามารถตรวจสอบได้ดังนี้:

- เลือกระยะวัดถาวรที่สามารถเปลี่ยนแปลงที่มีความยาว
ประมาณ 3 ถึง 10 ม. โดยที่ทานทราบความยาวนี้แล้ว
อย่างแม่นยำ (ต. ย. เช่น ความกว้างห้อง หรือ ช่องประตู)
ควรทำการวัดภายใต้สภาวะที่เอื้ออำนวยนั้นคือระยะวัดควร
อยู่ภายในอาคารโดยมีแสงพื้นหลังอ่อน และพื้นผิวเป้า
หมายของการวัดควรราบเรียบและสะท้อนแสงได้ดี (ต. ย.
เช่น ผนังทาสีขาว)
- วัดระยะทาง 10 ครั้งต่อเนื่องกัน

ในระยะเวลาวัดทั้งหมดและภายใต้เงื่อนไขที่ตี ส่วนเบี่ยงเบน
สูงสุดของการวัดแต่ละครั้งจากค่าเฉลี่ยต้องไม่เกิน ±2 มม.
บันทึกข้อมูลจากการวัดไว้เพื่อให้สามารถเปรียบเทียบความ
แม่นยำได้ในภายหลัง

**การตรวจสอบความแม่นยำและการสอบเทียบของ
ช่องมองภาพ (กากบาท)**

ตรวจสอบความแม่นยำของการวางแนวเลเซอร์และช่องมอง
ภาพอย่างสม่ำเสมอ

- เลือกพื้นที่ที่สว่าง มีแสงส่องน้อยที่สุด (ต. ย. เช่น ผนังสี
ขาว) ในระยะห่างอย่างน้อย 5 ม. เป็นเป้าหมาย
- ตรวจสอบว่าจุดเลเซอร์อยู่ภายในช่องมองภาพในจอแสดงผล
หรือไม่

หากจุดเลเซอร์ไม่อยู่ในช่องมองภาพ ท่านต้องสอบเทียบช่อง
มองภาพใหม่

เลือก **CL** ในการตั้งค่า ทำตามคำแนะนำบนจอแสดงผล
สำหรับระยะทางไกลกว่า (มากกว่าห้าเมตร) เครื่องหมายเป้า
หมายเพื่อทำเครื่องหมายจุดวัดจะปรากฏขึ้น

**การทำงานกับขาตั้งแบบสามขา (อุปกรณ์
ประกอบ)**

การใช้ขาตั้งแบบสามขาจำเป็นอย่างยิ่งสำหรับการวัดระยะ
ทางไกลๆ วางเครื่องมือวัดที่มีเกลียวขนาด 1/4" (17) เข้า
บนเพดยึดแบบเปลี่ยนเร็วของขาตั้งแบบสามขา (27) หรือ
ขาตั้งกล้องแบบสามขาทั่วไป ยึดเครื่องมือวัดโดยขันสลูว์ล็อก
ของเพดยึดแบบเปลี่ยนเร็วเข้าให้แน่น
ตั้งระนาบอ้างอิงสำหรับการวัดด้วยขาตั้งแบบสามขาในการ
ตั้งค่า (ระนาบอ้างอิงขาตั้งแบบสามขา)

**ข้อผิดพลาด - สาเหตุและมาตรการ
แก้ไข**

สาเหตุ	มาตรการแก้ไข
การเตือนอุณหภูมิเกิน ท้าการวัดไม่ได้	
อุณหภูมิเครื่องมือวัดอยู่นอก ช่วงอุณหภูมิใช้งาน -10 °C ถึง +45 °C (ในฟังก์ชันการวัดต่อเนื่องถึง +40 °C)	รอกกว่าอุณหภูมิเครื่องมือวัดอยู่ในช่วงอุณหภูมิใช้งาน
"ERROR" ปรากฏบนจอแสดงผล	
การเพิ่ม/การลดค่าจากการวัดด้วยค่าที่มีหน่วยวัดต่างกัน	เพิ่ม/ลดค่าจากการวัดที่มีหน่วยวัดเดียวกันเท่านั้น
มุมระหว่างลำแสงเลเซอร์กับเป้าหมายแคบเกินไป	ขยายมุมระหว่างลำแสงเลเซอร์กับเป้าหมาย
พื้นผิวเป้าหมายสะท้อนมาก (ต. ย. เช่น กระจก) หรือ สะท้อนไม่พอ (ต. ย. เช่น วัตถุสีดำ) หรือแสงรบกวนสว่างมากเกินไป	ใช้แผ่นเป้าหมายเลเซอร์ (25) (อุปกรณ์ประกอบ)
ทางออกลำแสงเลเซอร์ เลนส์รับแสง กล้องถ่ายรูป (ต. ย. เช่น เนื่องจากอุณหภูมิเปลี่ยนแปลงอย่างรวดเร็ว)	(19) ใช้ผ้านุ่มเช็ดทางออกลำแสงเลเซอร์ (19) เลนส์รับแสง (18) หรือกล้องถ่ายรูป (20) ให้แห้ง
ค่าที่คำนวณได้มากกว่า 999 999 หรือน้อยกว่า -999 999 ม./ม. ² /ม. ³	แบ่งการคำนวณเป็นตอนๆ
"CAL" และ "ERROR" ปรากฏบนจอแสดงผล	
การสอบเทียบของการวัดความลาดชันไม่ได้ดำเนินการในลำดับที่ถูกต้องหรือในตำแหน่งที่ถูกต้อง	สอบเทียบซ้ำตามคำแนะนำบนจอแสดงผลและในคู่มือการใช้งาน
พื้นผิวที่ใช้ในการสอบเทียบไม่ได้อยู่ในแนวนอนหรือแนวตั้งอย่างถูกต้อง	สอบเทียบซ้ำบนพื้นผิวในแนวนอนหรือแนวตั้ง และตรวจสอบพื้นผิววัดระดับนำก่อนหากจำเป็น
เครื่องมือวัดเคลื่อนที่หรือเอียงขณะกดปุ่ม	สอบเทียบซ้ำและจับเครื่องมือวัดให้นิ่งขณะกดปุ่ม
ผลลัพธ์จากการวัดไม่น่าจะเป็นจริง	

สาเหตุ	มาตรการแก้ไข
พื้นผิวเปียกหยาบสะท้อนแสง อย่างไม่ถูกต้อง (ต. ย. เช่น น้ำ กระຈก)	ปิดพื้นผิวเปียกหยาบ
ทางออกลำแสงเลเซอร์ (19) หรือเลนส์รับแสง (18) หรือ กล้องถ่ายรูป (20) ถูกบดบัง	ขจัดสิ่งกีดขวางออกจาก ทางออกลำแสงเลเซอร์ (19) เลนส์รับแสง (18) หรือ กล้องถ่ายรูป (20)
ตั้งระนาบอ้างอิงไม่ถูกต้อง	เลือกระดับอ้างอิงที่สอดคล้อง กับการวัด
มีสิ่งกีดขวางลำแสงเลเซอร์	จุดของลำแสงเลเซอร์ต้องอยู่ บนพื้นผิวเปียก หมายอย่างสมบูรณ์
ไม่สามารถเรียกใช้งาน Bluetooth®	
แบตเตอรี่อ่อนเกินไป	เปลี่ยนแบตเตอรี่
ไม่มี การเชื่อมต่อ Bluetooth®	
ข้อผิดพลาดในการเชื่อมต่อ Bluetooth®	ปิดสวิตช์ Bluetooth® ที่ เครื่องมือวัดและที่อุปกรณ์ เคลื่อนที่ปลายทาง และเปิดส วิตช์อีกครั้ง
	ตรวจสอบแอปพลิเคชันบนอ ุปกรณ์เคลื่อนที่ปลายทางของ ท่าน
	ตรวจสอบว่า Bluetooth® ที่เครื่องมือวัดของท่านและ อุปกรณ์เคลื่อนที่ปลายทางถูก เรียกใช้งานหรือไม่
	ตรวจหาการรบกวนก้างที่ อุปกรณ์เคลื่อนที่ปลายทาง ของท่าน
	ร่นระยะห่างระหว่างเครื่องมือ วัดและอุปกรณ์เคลื่อนที่ปลาย ทางของท่าน
	หลีกเลี่ยงอย่าให้มีสิ่งกีดขวาง (ต. ย. เช่น คอนกรีตเสริมเหล็ก ประตู โลหะ) ระหว่างเครื่องมือวัด และอุปกรณ์เคลื่อนที่ปลาย ทางของท่าน อยู่ให้ห่างจาก สนามแม่เหล็กไฟฟ้าที่เข้ามา รบกวน (ต. ย. เช่น อุปกรณ์ส่ง ระบบเครือข่ายไร้สาย WLAN)



เครื่องมือวัดจะตรวจสอบการทำงานที่ถูกต้อง
ของแต่ละการวัด หากตรวจพบข้อบกพร่อง
จอแสดงผลจะแสดงเฉพาะสัญลักษณ์ที่อยู่ด้าน
ข้างนี้เท่านั้น ในกรณีเช่นนี้ หรือเมื่อมาตรการ
แก้ไขดังกล่าวข้างต้นไม่สามารถตรวจแก้ความบกพร่องได้
ให้ส่งเครื่องมือวัดเข้ารับการตรวจสอบที่ศูนย์บริการหลังการ
ขายสำหรับเครื่องมือไฟฟ้า บอช

การบำรุงรักษาและการบริการ

การบำรุงรักษาและการทำความสะอาด

รักษาเครื่องมือวัดให้สะอาดตลอดเวลา
อย่าจุ่มเครื่องมือวัดลงในน้ำหรือของเหลวอื่นๆ
เช็ดสิ่งสกปรกออกด้วยผ้าแห้งที่เปียกหมาดๆอย่าใช้สารซักฟอก
หรือตัวทำละลาย

ทำความสะอาดโดยเฉพาะเลนส์รับแสง (18) ทางออก
ลำแสงเลเซอร์ (19) และกล้องถ่ายรูป (20) ด้วยความ
ระมัดระวังอย่างยิ่ง : ตรวจสอบให้แน่ใจว่าไม่มีสิ่งสกปรกติด
บนเลนส์รับแสง ทางออกลำแสงเลเซอร์ และกล้องถ่ายรูป
ทำความสะอาดเลนส์รับแสง ทางออกลำแสงเลเซอร์ และ
กล้องถ่ายรูป ด้วยสารที่เหมาะสมสำหรับเลนส์กล้องถ่ายรูป
เท่านั้น อย่าพยายามใช้วัตถุมีคมเช็ดสิ่งสกปรกออกจากเลนส์
รับแสง ทางออกลำแสงเลเซอร์ หรือกล้องถ่ายรูป และอย่า
เช็ดบนอุปกรณ์เหล่านี้ (เสี่ยงต่อการถูกขูดขีด)
ในกรณีซ่อมแซม ให้ส่งเครื่องมือวัดโดยบรรจุลงในกระเป๋าใส่
เครื่องมือวัด (23)

การบริการหลังการขายและการให้คำปรึกษาการ ใช้งาน

ศูนย์บริการหลังการขายของเรายินดีตอบคำถามของ
ท่านที่เกี่ยวกับการบำรุงรักษาและการซ่อมแซมผลิตภัณฑ์รวมทั้ง
เรื่องอะไหล่ ภาพเขียนแบบการประกอบและข้อมูลเกี่ยวกับ
อะไหล่ กรุณาดูใน: www.bosch-pt.com
ทีมงานที่ปรึกษาของ บอช ยินดีให้ข้อมูลเกี่ยวกับผลิตภัณฑ์
ของเราและอุปกรณ์ประกอบต่างๆ
เมื่อต้องการสอบถามและสั่งซื้ออะไหล่ กรุณาแจ้งหมายเลข
สินค้า 10 หลักบนแผนป้ายรุ่นของผลิตภัณฑ์ทุกครั้ง

ไทย

ไทย บริษัท โรเบิร์ต บอช จำกัด
เอฟวายไอ เซ็นเตอร์ อาคาร 1 ชั้น 5
เลขที่ 2525 ถนนพระราม 4
แขวงคลองเตย เขตคลองเตย กรุงเทพฯ 10110
โทร: +66 2012 8888
แฟกซ์: +66 2064 5800
www.bosch.co.th

ศูนย์บริการซ่อมและฝึกอบรม บ้อช
อาคาร ลานชาลาทาวเวอร์ ชั้น G ห้องเลขที่ 2
บ้านเลขที่ 10/11 หมู่ 16
ถนนศรีนครินทร์ ตำบลบางแก้ว อำเภอบางพลี
จังหวัดสมุทรปราการ 10540
ประเทศไทย
โทรศัพท์ 02 7587555
โทรสาร 02 7587525

การกำจัดขยะ

เครื่องมือวัด อุปกรณ์ประกอบ และหีบห่อ ต้องนำไปแยกประเภทวัสดุเพื่อส่งเข้าสู่กระบวนการรีไซเคิลที่เป็นมิตรต่อสิ่งแวดล้อม



อย่าทิ้งเครื่องมือวัดและแบตเตอรี่ลงในขยะบ้าน!

Bahasa Indonesia

Petunjuk Keselamatan



Petunjuk lengkap ini harus dibaca dan diperhatikan agar tidak terjadi bahaya dan Anda dapat bekerja dengan aman saat menggunakan alat ukur ini. Apabila alat ukur tidak digunakan sesuai dengan petunjuk yang disertakan, keamanan alat ukur dapat terganggu. Janganlah sekali-kali menutupi atau melepas label keselamatan kerja yang ada pada alat ukur ini. **SIMPAN PETUNJUK INI DENGAN BAIK DAN BERIKAN KEPADA PEMILIK ALAT UKUR BERIKUTNYA.**

- ▶ **Perhatian** – jika perangkat pengoperasian atau perangkat pengaturan atau prosedur lain selain yang dituliskan di sini digunakan, hal ini dapat menyebabkan terjadinya paparan radiasi yang berbahaya.
- ▶ Alat ukur dikirim dengan label peringatan (ditandai dengan gambar alat ukur di halaman grafis).
- ▶ Jika teks pada tanda peringatan tidak tertulis dalam bahasa negara Anda, tempelkan label yang tersedia dalam bahasa negara Anda di atas label berbahasa Inggris sebelum Anda menggunakan alat untuk pertama kalinya.



Jangan melihat sinar laser ataupun mengarahkannya kepada orang lain atau hewan baik secara langsung maupun dari pantulan. Sinar laser dapat membutakan seseorang, menyebabkan kecelakaan atau merusak mata.

- ▶ **Jika radiasi laser mengenai mata, tutup mata Anda dan segera gerakan kepala agar tidak terkena sorotan laser.**
- ▶ **Jangan mengubah peralatan laser.**
- ▶ **Jangan gunakan kacamata pelihat laser sebagai kacamata pelindung.** Kacamata pelihat laser disediakan agar dapat mendeteksi laser dengan lebih baik, namun tidak melindungi dari sinar laser.
- ▶ **Jangan gunakan kacamata pelihat laser sebagai sunglasses atau di jalan raya.** Kacamata pelihat laser tidak menawarkan perlindungan penuh terhadap sinar UV dan mengurangi persepsi warna.
- ▶ **Perbaiki alat ukur hanya di teknisi ahli resmi dan gunakan hanya suku cadang asli.** Dengan demikian, keselamatan kerja dengan alat ukur ini selalu terjamin.
- ▶ **Jangan biarkan anak-anak menggunakan alat ukur laser tanpa pengawasan.** Anda dapat secara tidak sengaja membuat orang menjadi buta.
- ▶ **Jangan mengoperasikan alat ukur di area yang berpotensi meledak yang di dalamnya terdapat cairan, gas, atau serbuk yang dapat terbakar.** Di dalam alat pengukur dapat terjadi bunga api, yang lalu menyulut debu atau uap.
- ▶ **Waspada! Ketika menggunakan alat pengukur dengan Bluetooth® dapat terjadi gangguan pada perangkat dan instalasi lain, pesawat terbang, dan perangkat medis (misalnya alat pacu jantung, alat bantu dengar).** Selain itu, cedera pada manusia dan binatang di area sekitar tidak dapat seluruhnya dihindari. **Jangan menggunakan alat pengukur dengan Bluetooth® di dekat perangkat medis, pusat pengisian bahan bakar, instalasi kimia, dan area dengan bahaya ledakan.** **Jangan menggunakan alat pengukur dengan Bluetooth® dalam pesawat terbang.** **Hindari pengoperasian di dekat kepala secara langsung dalam waktu yang lama.**

Penanda istilah *Bluetooth®* serta gambar simbol (logo) merupakan merek dagang terdaftar dan kepemilikan dari Bluetooth SIG, Inc. Setiap penggunaan penanda istilah/gambar simbol ini berada di bawah lisensi Robert Bosch Power Tools GmbH.

Spesifikasi produk dan performa

Perhatikan ilustrasi yang terdapat pada bagian depan panduan pengoperasian.

Tujuan penggunaan

Alat pengukur merupakan instrumen untuk mengukur jarak, panjang, tinggi, celah dan untuk menghitung luas bidang dan volume.

Hasil ukur dapat dikirim melalui *Bluetooth®* ke perangkat lainnya.

Alat ukur ditujukan untuk digunakan di dalam maupun di luar ruangan.

Ilustrasi komponen

Nomor-nomor pada ilustrasi komponen sesuai dengan gambar alat pengukur pada halaman gambar.

- (1) Display
- (2) Tombol ukur [] (dapat digunakan di depan atau samping)
- (3) Softkey []
- (4) Tombol plus [] /Pilih ke kanan
- (5) Tombol zoom
- (6) Tempat pemasangan tali pergelangan tangan
- (7) Tombol melepas pin pengukur
- (8) Pin pengukur
- (9) Tombol on/off []
- (10) Tombol display sasaran
- (11) Tombol minus [] /Pilih ke kiri
- (12) Softkey []
- (13) Tombol fungsi []
- (14) Label peringatan laser
- (15) Nomor seri
- (16) Tutup kompartemen baterai
- (17) Soket tripod 1/4"
- (18) Lensa penerima
- (19) Outlet sinar laser
- (20) Kamera
- (21) Kenop putar
- (22) Baterai
- (23) Kantong pelindung
- (24) Tali pergelangan tangan
- (25) Panel sasaran laser ^{A)}
- (26) Kacamata laser ^{A)}
- (27) Tripod ^{A)}

A) Aksesoris yang ada pada gambar atau yang dijelaskan tidak termasuk dalam lingkup pengiriman standar. Semua aksesoris yang ada dapat Anda lihat dalam program aksesoris kami.

Simbol pada display

- (a) Baris hasil pengukuran
- (b) Display sasaran (hair cross)
- (c) Tampilan sudut kemiringan
- (d) Tanggal/waktu
- (e) Bidang acuan pengukuran
- (f) Status koneksi
 - Bluetooth® tidak diaktifkan
 - Bluetooth® aktif, koneksi dihasilkan
- (g) Indikator level pengisian daya baterai
- (h) Garis nilai pengukuran
- (i) Pengaturan (softkey)

- (j) Fungsi pengukuran yang dipilih
- (k) Memori internal (softkey)
- (l) Fungsi bantuan yang terintegrasi (softkey)
- (m) Kembali (softkey)
- (n) Layar awal (softkey)
- (o) Pengaturan perangkat

Data teknis

Laser pengukur jarak digital		GLM 150 C
Nomor seri	3 601 K72 F..	
Rentang pengukuran (khusus)	0,08–150 m ^{A)}	
Rentang pengukuran (kondisi khusus dan tidak menguntungkan)	0,08–60 m ^{B)}	
Akurasi pengukuran (khusus)	±1,5 mm ^{A)}	
Akurasi pengukuran (kondisi khusus dan tidak menguntungkan)	±3,0 mm ^{B)}	
Unit display terkecil	0,5 mm	
Waterpas dan pengukuran jarak tidak langsung		
Rentang pengukuran	0°–360° (4x90°)	
Pengukuran kemiringan		
Rentang pengukuran	0°–360° (4x90°)	
Akurasi pengukuran (khusus)	±0,2° ^{C) D) E)}	
Unit display terkecil	0,1°	
Umum		
Suhu pengoperasian	–10°C ... +45°C ^{F)}	
Suhu penyimpanan	–20°C ... +70°C	
Rentang suhu yang diizinkan untuk pengisian daya	+5°C...+40°C	
Kelembapan relatif maks.	90%	
Ketinggian maksimal di atas tinggi acuan	2000 m	
Tingkat polusi sesuai dengan IEC 61010-1	2 ^{G)}	
Kelas laser	2	
Jenis laser	650 nm, < 1 mW	
Diameter sinar laser (pada suhu 25°C) sekitar		
– dalam jarak 10 m	9 mm	
– dalam jarak 100	90 mm	
Penonaktifan otomatis setelah sekitar		
– Laser	20 detik	
– Alat pengukur (tanpa pengukuran)	5 menit ^{H)}	

Lasер pengukur jarak digital **GLM 150 C**

Baterai	3 x 1,5 V LR6 (AA)
Berat sesuai dengan EPTA-Procedure 01:2014	0,23 kg
Ukuran	142 (176) x 64 x 28 mm
Jenis keamanan	IP 54 (terlindung dari debu dan percikan air)

Transmisi data

Bluetooth®	Bluetooth® (4.2 low energy) ¹⁾
Pita frekuensi pengoperasian	2402 – 2480 MHz
Daya transmisi maks.	8 mW

- A) Saat mengukur dari tepi depan alat pengukur, berlaku untuk daya pantul objek yang tinggi (misalnya dinding yang dicat putih), pencahayaan latar belakang yang lemah, dan suhu pengoperasian sebesar 25°C. Selain itu, penyimpangan sebesar ± 0,05 mm/m juga harus diperhitungkan.
- B) Pada saat mengukur dari tepi depan alat pengukur, berlaku kemampuan refleksi tujuan yang tinggi (misalnya dinding yang dicat putih), pencahayaan latar belakang lebih kuat. Selain itu, penyimpangan sebesar ± 0,15 mm/m juga harus diperhitungkan.
- C) Berdasarkan kalibrasi pada sudut 0° dan 90°. Dapat terjadi kesalahan gradien maks. ±0,01°/derajat hingga 45°. Akurasi pengukuran mengacu pada tiga orientasi kalibrasi pengukuran kemiringan, lihat ilustrasi H
- D) Pada suhu pengoperasian 25°C
- E) Sisi kiri alat pengukur digunakan sebagai bidang acuan untuk mengukur kemiringan.
- F) Suhu pengoperasian maksimal pada fungsi pengukuran kontinu yakni +40°C.
- G) Hanya polusi nonkonduktif, namun terkadang muncul konduktivitas sementara yang disebabkan oleh kondensasi
- H) Waktu penonaktifan otomatis dapat diatur (2, 5, 10 menit atau tidak sama sekali).
- I) Sambungan mungkin tidak dapat dibuat pada perangkat Bluetooth® Low Energy tergantung pada model dan sistem pengoperasian. Perangkat Bluetooth® harus mendukung profil GATT.

Nomor seri (15) pada label tipe berfungsi sebagai identifikasi alat pengukur Anda.

Cara memasang

Memasukkan/mengganti baterai

Untuk pengoperasian alat pengukur disarankan memakai baterai mangan alkali.

- Tekan tombol pelepas (7) dan keluarkan pin pengukur (8) sebesar 180°.
- Untuk membuka penutup kompartemen baterai (16) lipat kenop putar (21) ke atas dan putar seperempat putaran berlawanan dengan arah jarum jam. Buka penutup kompartemen baterai pada kenopnya. Masukkan baterai. Pastikan baterai terpasang pada posisi kutub yang benar sesuai gambar di dalam penutup baterai.

- ▶ **Keluarkan baterai dari alat pengukur jika tidak digunakan dalam waktu yang lama.** Jika baterai disimpan untuk waktu yang lama, baterai dapat berkarat dan dayanya akan habis dengan sendirinya.
- ▶ **Catatan:** TrackMyTools hanya dapat berfungsi jika terdapat baterai.

Penggunaan

Cara penggunaan

- ▶ **Jangan biarkan alat ukur yang aktif berada di luar pengawasan dan matikan alat ukur setelah digunakan.** Sinar laser dapat menyilaukan mata orang lain.
- ▶ **Lindungilah alat ukur dari cairan dan sinar matahari langsung.**
- ▶ **Jauhkan alat ukur dari suhu atau perubahan suhu yang ekstrem.** Jangan biarkan alat ukur berada terlalu lama di dalam kendaraan. Biarkan alat ukur menyesuaikan suhu lingkungan sebelum dioperasikan saat terjadi perubahan suhu yang drastis. Pada suhu yang ekstrem atau terjadi perubahan suhu yang drastis, ketepatan alat ukur dapat terganggu.
- ▶ **Hindari guncangan atau benturan yang keras pada alat ukur.** Apabila setelah terjadi pengaruh eksternal yang kuat pada alat ukur, disarankan untuk memeriksa akurasi alat ukur sebelum digunakan kembali (lihat „Pemeriksaan akurasi pada pengukuran jarak“, Halaman 59).
- ▶ **Alat pengukur dilengkapi dengan antarmuka nirkabel. Perhatikan batasan pengoperasian lokal, misalnya dalam pesawat terbang atau di rumah sakit.**

Mengaktifkan/menonaktifkan perkakas listrik

Selama bekerja, pastikan bahwa lensa penerima (18), outlet sinar laser (19) dan kamera (20) tidak tertutup atau terselubung, jika tidak, akan terjadi kesalahan pengukuran.

- Untuk **menyalakan** alat pengukur dan laser, tekan singkat tombol ukur di depan atau samping (2) [▲].
- Untuk **menyalakan** alat pengukur tanpa laser, tekan singkat tombol on/off (9) [⊕].
- ▶ **Jangan mengarahkan sinar laser pada orang lain atau binatang dan jangan melihat ke sinar laser, juga tidak dari jarak jauh.**

Untuk **mematikan** laser, tekan singkat tombol on/off (9) [⊕].

Untuk **mematikan** kamera, tekan tombol display sasaran (10).

Untuk **mematikan** alat pengukur, tekan dan tahan tombol on/off (9) [⊕].

Saat menonaktifkan alat pengukur, nilai yang disimpan pada memori dan pengaturan perangkat akan tetap tersimpan.

Kamera

Saat alat pengukur dinyalakan pertama kali, kamera (20) menyala secara otomatis. Untuk mematkannya, tekan tombol display sasaran (10).

Pengaturan kamera (on/off) disimpan saat alat pengukur dimatikan.

Pengoptimalan visibilitas titik laser

Saat alat pengukur digunakan terutama di tempat terbuka, terkena paparan sinar matahari atau juga saat pengukuran jarak jauh dalam interior, titik laser mungkin tidak terlihat. Visibilitas titik laser/sasaran pengukuran dapat ditingkatkan untuk menyalakan kamera:

- Pengaturan kecerahan display (pengaturan perangkat)
- Penggunaan zoom dengan tombol (5).

Prosedur pengukuran

Setelah diaktifkan, alat pengukur berada dalam fungsi pengukuran panjang. Tekan tombol (13) [Func] untuk fungsi ukur lainnya. Pilih fungsi pengukuran yang diinginkan menggunakan tombol (4) [+] atau tombol (11) [-] dari . Aktifkan fungsi pengukuran menggunakan tombol (13) [Func] atau tombol ukur (2) [▲].

Setelah diaktifkan, tepi belakang alat pengukur telah dipilih sebagai bidang acuan untuk pengukuran. Untuk mengubah bidang acuan (lihat „Memilih bidang acuan (lihat gambar A)“, Halaman 54). Letakkan alat pengukur pada titik awal pengukuran yang diinginkan (misalnya dinding).

Catatan: Jika alat pengukur diaktifkan menggunakan tombol on/off (9) [⊕] tekan singkat tombol ukur (2) [▲] untuk menyalakan laser.

Untuk memulai pengukuran, tekan singkat tombol ukur (2) [▲]. Lalu sinar laser akan dinonaktifkan. Ulangi prosedur ini untuk pengukuran selanjutnya.

Jika sinar laser permanen dinyalakan dan sedang berada pada fungsi pengukuran kontinu, pengukuran dimulai setelah tombol ukur (2) [▲] ditekan pertama kali.

- ▶ **Jangan mengarahkan sinar laser pada orang lain atau binatang dan jangan melihat ke sinar laser, juga tidak dari jarak jauh.**

Catatan: Nilai pengukuran biasanya muncul dalam waktu 0,5 detik dan paling lambat setelah 4 detik. Periode pengukuran tergantung pada jarak, rasio cahaya, dan karakter refleksi permukaan tujuan. Setelah pengukuran selesai, sinar laser akan secara otomatis dimatikan. Sinar laser permanen yang dihidupkan tidak dimatikan setelah pengukuran.

Memilih bidang acuan (lihat gambar A)

Untuk melakukan pengukuran, empat bidang acuan berikut dapat dipilih:

- tepi belakang alat pengukur (misalnya saat mengukur dari dinding),
- ujung pin pengukur yang terlipat sebesar 180° (8) (misalnya untuk mengukur dari sudut),

- tepi depan alat pengukur (misalnya saat mengukur dari tepi meja),
- bagian tengah ulir (17) (misalnya: untuk mengukur dengan tripod)

Pembukaan atau penutupan pin pengukur (8) sebesar 180° akan dideteksi secara otomatis dan bidang acuan yang bersangkutan akan direkomendasikan. Konfirmasi pengaturan dengan tombol ukur (2) [▲].

Pilih pengaturan alat pengukur menggunakan tombol softkey (3) [■]. Pilih bidang acuan dengan tombol (4) [+] atau tombol (11) [-] dan konfirmasi dengan tombol (13) [Func].

Setelah setiap pengaktifan alat pengukur, tepi belakang alat pengukur akan secara otomatis ditetapkan sebagai bidang acuan.

Sinar laser permanen

Jika perlu, alat pengukur juga dapat diatur menjadi sinar laser permanen. Pilih pengaturan alat pengukur menggunakan tombol softkey (3) [■]. Pilih sinar laser permanen dengan tombol (4) [+] atau tombol (11) [-] dan konfirmasi dengan tombol (13) [Func].

- ▶ **Jangan mengarahkan sinar laser pada orang lain atau binatang dan jangan melihat ke sinar laser, juga tidak dari jarak jauh.**

Pada pengaturan ini, sinar laser juga tetap menyala selama pengukuran, untuk mengukur hanya perlu dengan menekan singkat tombol ukur (2) [▲] satu kali.

Sinar laser permanen dimatikan kembali dalam pengaturan atau secara otomatis saat alat pengukur dimatikan.

Menu "Pengaturan"

Untuk masuk ke menu "Pengaturan" (i), tekan singkat softkey (3) [■] atau tekan dan tahan tombol (13) [Func]. Pilih pengaturan yang diinginkan dengan tombol (4) [+] atau tombol (11) [-] dan konfirmasi dengan tombol (13) [Func]. Pilih pengaturan yang diinginkan.

Untuk keluar dari menu "Pengaturan", tekan tombol on/off (9) [⊕] atau tombol softkey (12) [■].

Pengaturan	
	
	Bluetooth®
	Bidang acuan
	Fungsi pengatur waktu
	Sinar laser permanen
	Kalibrasi pengukuran kemiringan
	Kalibrasi display sasaran
	Pengaturan perangkat

Fungsi pengatur waktu

Fungsi pengatur waktu membantu misalnya saat mengukur lokasi yang sulit dijangkau atau saat pergerakan alat pengukur terhambat selama pengukuran.

Pilih fungsi pengatur waktu dalam pengaturan. Pilih jangka waktu yang diinginkan dari pelepasan pin pengukur hingga pengukuran dan konfirmasi dengan tombol ukur **(2)** [▲] atau tombol **(13)** [Func].

Kemudian, tekan tombol ukur **(2)** [▲] untuk menyalakan sinar laser dan menentukan titik sasaran. Tekan kembali tombol ukur **(2)** [▲] untuk melakukan pengukuran. Pengukuran dilakukan setelah jangka waktu yang ditentukan. Nilai pengukuran akan ditampilkan pada baris hasil **(a)**.

Jangka waktu mulai dari pelepasan pin pengukur hingga pengukuran ditampilkan pada status bar di atas.







Pengukuran kontinu (terus-menerus) maupun pengukuran minimum/maksimum tidak dapat dilakukan saat berada dalam fungsi pengatur waktu.

Pengatur waktu akan tetap aktif hingga alat pengukur dimatikan atau hingga dimatikan pada menu "Pengaturan".

Menu "Pengaturan perangkat"

Pilih menu "Pengaturan perangkat" dalam menu "Pengaturan".

Pilih pengaturan perangkat yang diinginkan dengan tombol **(4)** [+] atau tombol **(11)** [-] dan konfirmasi dengan tombol **(13)** [Func]. Pilih pengaturan perangkat yang diinginkan. Untuk keluar dari menu "Pengaturan perangkat" **(o)**, tekan tombol on/off **(9)** [⊕] atau tombol softkey **(12)** [■].

Pengaturan perangkat	
	
	Bahasa
	Waktu & tanggal
ft/m	Satuan ukur
	Satuan sudut
	TrackMyTools
i	Info perangkat
	Tanda bunyi
	Waktu penonaktifan
	Peredup cahaya
	Kecerahan display
	Orientasi display

Mengatur bahasa

Pilih "Bahasa" dalam pengaturan perangkat. Atur bahasa yang diinginkan dan konfirmasi dengan tombol **(13)** [Func] atau tombol ukur **(2)** [▲].

Mengatur tanggal dan waktu

Pilih "Waktu & tanggal" dalam pengaturan perangkat. Atur tanggal dan waktu sesuai petunjuk pada display dan konfirmasi dengan softkey **(12)** [■].

Catatan: Tanggal dan waktu harus diatur kembali setelah mengganti baterai.

Mengubah satuan ukur

Pilih "Satuan ukur" dalam pengaturan perangkat. Satuan ukur pengaturan standar adalah "m" (meter).

Atur satuan ukur yang diinginkan dan konfirmasi dengan tombol **(13)** [Func].

Untuk keluar dari item menu, tekan tombol on/off **(9)** [⊕] atau tombol softkey **(3)** [■]. Pengaturan perangkat yang telah dipilih akan tetap tersimpan setelah alat pengukur dimatikan.

Mengubah satuan sudut

Pilih "Satuan sudut" dalam pengaturan perangkat. Pengaturan dasarnya adalah satuan sudut „°“ (derajat).

Atur satuan sudut yang diinginkan dan konfirmasi dengan tombol **(13)** [Func].

Untuk keluar dari item menu, tekan tombol on/off **(9)** [⊕] atau tombol softkey **(3)** [■]. Pengaturan perangkat yang telah dipilih akan tetap tersimpan setelah alat pengukur dimatikan.

TrackMyTools

Pilih "TrackMyTools" dalam pengaturan perangkat. Konfirmasi pengaturan dengan tombol **(13)** [Func].

Aktivasi pertama kali harus dilakukan. Pengiriman data hanya dapat dilakukan dengan aplikasi atau program PC yang sesuai.

TrackMyTools dapat dinonaktifkan kembali setiap saat. Pengaturan TrackMyTools (aktif/nonaktif) disimpan setelah alat pengukur dimatikan.

Catatan: TrackMyTools hanya dapat berfungsi jika terdapat baterai. Untuk mengaktifkan TrackMyTools setelah penggantian baterai, alat pengukur harus dinyalakan sebentar.

Pencahayaan display

Pilih "Peredup cahaya" dalam pengaturan perangkat.

Pencahayaan display diaktifkan secara permanen. Jika tidak ada tombol yang ditekan, pencahayaan display akan meredup setelah sekitar 30 detik untuk menghemat baterai.

Waktu hingga mulainya pengaktifan peredup cahaya dapat diatur (pengaturan perangkat).

Kecerahan display dapat disesuaikan dengan kondisi lingkungan sekitar dalam beberapa tingkatan (pengaturan perangkat).

Fungsi pengukuran

Catatan: Fungsi bantuan yang terintegrasi

Pada alat pengukur terdapat bantuan berupa animasi untuk setiap fungsi pengukuran. Pilih tombol **(13)** [Func], tombol **(4)** [+] atau **(11)** [-] lalu tombol softkey **(3)** [■]. Animasi tersebut menunjukkan prosedur terperinci untuk fungsi pengukuran yang dipilih.

Animasi dapat dihentikan dan dimulai ulang setiap saat dengan tombol **(3)** [■]. Gunakan tombol **(4)** [+] atau **(11)** [-] untuk bergulir bolak-balik.

Pengukuran panjang

Pilih pengukuran panjang .

Untuk mengaktifkan sinar laser, tekan singkat tombol ukur (2) [▲].

Untuk pengukuran, tekan singkat tombol ukur (2) [▲]. Hasil pengukuran ditampilkan di display bagian bawah.

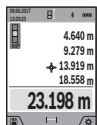

Ulangi langkah di atas saat setiap kali mengukur. Nilai ukur terakhir terletak pada display bagian bawah, nilai kedua terakhir berada di atasnya dan seterusnya.

Pengukuran kontinu

Saat melakukan pengukuran kontinu, alat pengukur dapat digerakkan tergantung target dengan nilai pengukuran yang diperbarui kira-kira setiap 0,5 detik. Pengguna dapat menjauh dari dinding hingga ke suatu jarak tertentu selama jarak saat ini selalu dapat terbaca.

Pilih pengukuran kontinu --- .

Untuk mengaktifkan sinar laser, tekan singkat tombol ukur (2) [▲].

Gerakkan alat pengukur sekian lama hingga jarak yang diinginkan muncul pada display di bagian bawah.

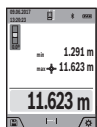

Dengan menekan sebentar tombol ukur (2) [▲] pengukuran kontinu dibatalkan. Nilai ukur saat ini akan ditampilkan pada display bagian bawah. Nilai ukur maksimal dan minimal terletak di atasnya. Pengukuran kontinu akan dimulai ulang dengan menekan kembali tombol ukur (2) [▲].

Pengukuran kontinu akan berhenti secara otomatis setelah 5 menit.

Pengukuran luas

Pilih pengukuran luas \square .

Kemudian ukur lebar dan panjang secara bergantian seperti dalam pengukuran panjang. Di antara dua pengukuran tersebut, sinar laser tetap menyala. Jarak yang diukur berkedip pada tampilan pengukuran luas \square (lihat elemen display (j)).

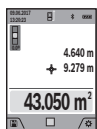

Nilai ukur pertama ditampilkan pada display bagian atas.

Setelah selesai pengukuran kedua, luas permukaan secara otomatis dihitung dan ditampilkan. Hasil akhir terletak di display bagian bawah, nilai ukur tunggal terletak di

atasnya.

Pengukuran volume

Pilih pengukuran volume \square .

Kemudian ukur lebar, panjang dan kedalaman secara bergantian seperti dalam pengukuran panjang. Di antara tiga pengukuran tersebut, sinar laser tetap menyala. Jarak yang diukur berkedip pada tampilan pengukuran volume \square (lihat elemen display (j)).



Nilai ukur pertama ditampilkan pada display bagian atas.

Setelah pengukuran ketiga selesai, volume dihitung secara otomatis dan ditampilkan.

Hasil akhir terletak di display bagian bawah, nilai ukur tunggal terletak di atasnya.

Pengukuran jarak tidak langsung

Pilih pengukuran jarak tidak langsung \triangle . Terdapat empat fungsi pengukuran jarak tidak langsung yang dapat digunakan untuk menentukan jarak yang berbeda-beda. Pengukuran jarak tidak langsung digunakan untuk menentukan jarak yang tidak dapat diukur secara langsung karena ada sesuatu yang menghalangi jalannya sinar atau tidak ada permukaan yang tersedia sebagai reflektor. Cara pengukuran ini hanya dapat dilakukan dalam arah vertikal. Segala deviasi dalam arah horizontal akan menyebabkan kesalahan dalam pengukuran.

Catatan: Pengukuran jarak tidak langsung selalu tidak akurat dibandingkan dengan pengukuran jarak langsung. Kesalahan pengukuran dapat lebih besar daripada pengukuran langsung tergantung pada pemakaiannya. Untuk ketepatan pengukuran yang lebih baik, kami menyarankan untuk menggunakan sebuah tripod (aksesori). Sinar laser akan tetap hidup di antara pengukuran tunggal

a) Pengukuran tinggi tidak langsung (lihat gambar B)

Pilih pengukuran tinggi tidak langsung \triangle .

Pastikan alat pengukur berada pada ketinggian yang sama dengan titik pengukuran bawah. Lalu miringkan alat pengukur pada bidang acuan dan ukur jarak "1" seperti saat mengukur panjang (pada display digambarkan dengan garis merah).

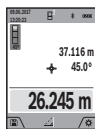

Setelah pengukuran selesai dilakukan, hasil untuk jarak yang dicari "X" ditampilkan pada baris hasil (a). Nilai pengukuran pada jarak "1" dan sudut "α" terletak pada baris nilai ukur (h).

b) Pengukuran tinggi ganda tidak langsung (lihat gambar C)

alat pengukur dapat mengukur secara tidak langsung semua jarak yang terletak pada bidang vertikal alat pengukur. Pilih pengukuran tinggi ganda tidak langsung \triangle . Ukur jarak "1" dan "2" seperti pada pengukuran panjang dalam urutan ini.

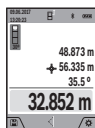

Setelah pengukuran selesai dilakukan, hasil untuk jarak "X" yang dicari ditampilkan pada baris hasil (a). Nilai pengukuran untuk jarak "1", "2" dan sudut "α" terletak pada baris nilai hasil (h).

Pastikan bidang acuan pengukuran (misalnya tepi belakang alat pengukur) tetap berada pada posisi yang sama saat semua pengukuran tunggal dalam prosedur pengukuran.

c) Pengukuran panjang tidak langsung (lihat gambar D)

Pilih pengukuran panjang tidak langsung \triangle .

Pastikan alat pengukur berada pada ketinggian yang sama dengan titik ukur yang dicari. Lalu miringkan alat pengukur pada bidang acuan dan ukur jarak "1" seperti saat mengukur panjang.

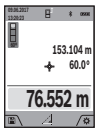

Setelah pengukuran selesai dilakukan, hasil untuk jarak "X" yang dicari ditampilkan pada baris hasil (a). Nilai pengukuran pada jarak "1" dan sudut "α" terletak pada baris nilai ukur (h).

d) Pengukuran trapesium (lihat gambar E)

Pengukuran trapesium, misalnya, dapat digunakan untuk menentukan panjang kemiringan atap.

Pilih pengukuran trapesium

Ukur jarak "1", "2" dan "3" seperti pada pengukuran panjang dalam urutan ini. Pastikan pengukuran jarak "3" dimulai tepat di titik akhir jarak "1" dan di antara jarak "1" dan "2" serta di antara jarak "1" dan "3" terdapat sudut kanan.

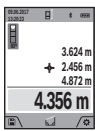

Setelah pengukuran terakhir selesai dilakukan, hasil untuk jarak "X" yang dicari ditampilkan pada baris hasil (a). Nilai pengukuran tunggal terletak pada garis nilai pengukuran (h).

Pengukuran luas dinding (lihat gambar F)

Pengukuran luas dinding digunakan untuk menentukan jumlah dari beberapa bidang tunggal dengan ketinggian yang sama. Pada contoh yang ditampilkan, luas keseluruhan beberapa dinding perlu ditentukan yang memiliki ketinggian ruang yang sama H namun panjang L yang berbeda.

Pilih pengukuran luas permukaan dinding

Ukur ketinggian ruang H seperti saat mengukur panjang. Nilai ukur akan ditampilkan di baris atas nilai ukur. Sinar laser tetap menyala.

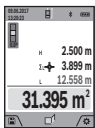

Kemudian ukur panjang L_1 dinding pertama. Luas akan dihitung secara otomatis dan ditampilkan pada baris hasil (a). Nilai ukur terakhir terletak di baris bawah nilai ukur (h). Sinar laser tetap menyala.

Selanjutnya, ukur panjang L_2 dinding kedua.

Nilai ukur satuan yang ditampilkan pada baris nilai ukur (h) akan ditambahkan ke panjang L_1 . Jumlah kedua panjang (ditampilkan di baris tengah nilai ukur (h)) akan dikalikan dengan tinggi yang telah tersimpan H. Nilai luas keseluruhan akan ditampilkan pada baris hasil (a).

Panjang L_x lainnya yang ditambahkan secara otomatis dan dikalikan dengan tinggi H dapat diukur secara opsional. Syarat penghitungan luas permukaan yang benar yakni panjang yang telah diukur pertama (sebagai contoh, tinggi ruang H) identik untuk semua luas permukaan parsial.

Fungsi peninjau (lihat gambar G)

Fungsi peninjau akan mengukur secara berulang-ulang panjang yang ditentukan (jarak). Panjang ini dapat ditransfer ke permukaan untuk memungkinkan pemotongan material dengan panjang potongan yang sama atau untuk mengatur dinding partisi pada konstruksi drywall. Panjang minimal yang dapat diatur sebesar 0,1 m, panjang maksimal sebesar 50 m.

Catatan: Pada stake out function (fungsi peninjau), jarak ke penanda akan ditampilkan pada display. Ujung alat pengukur bukan acuan.

Pilih fungsi peninjau

Atur panjang yang diinginkan dengan tombol (4) [+] atau tombol (11) [-].

Hidupkan fungsi peninjau dengan menekan tombol ukur (2) [▲], dan jauhkan secara perlahan dari titik awal.



alat pengukur terus mengukur jarak ke titik awal. Dengan itu panjang yang telah ditentukan serta nilai ukur saat ini akan ditampilkan. Panah atas atau bawah menunjukkan jarak terkecil untuk penandaan terakhir atau berikutnya.

Catatan: Saat mengukur secara berkelanjutan, nilai yang telah diukur sebagai panjang ditentukan dapat ditentukan dengan menekan dan menahan tombol ukur (2) [▲].



Koefisien kiri menunjukkan frekuensi panjang yang ditentukan yang telah tercapai. Panah hijau samping pada display menunjukkan panjang yang dicapai untuk tujuan penandaan.

Tanda panah merah atau tulisan merah menunjukkan nilai sebenarnya jika nilai acuan berada di luar display.

Pengukuran kemiringan/waterpas digital

Pilih pengukur kemiringan/waterpas digital

alat pengukur beralih secara otomatis di antara dua kondisi.

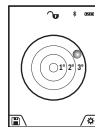

Waterpas digital digunakan untuk menguji arah vertikal atau horizontal suatu objek (contoh: mesin cuci, kulkas, dsb).

Jika sudut kemiringan 3° terlampaui, bola akan menyala merah pada display.

Sisi bawah alat pengukur berfungsi sebagai bidang acuan untuk waterpas digital.

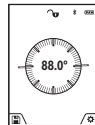

Pengukuran kemiringan digunakan untuk mengukur tanjakan atau turunan (contoh: pada tangga, selurus pagar, saat mengukur mebel, saat mengatur posisi pipa, dll.).

Sisi kiri alat pengukur digunakan sebagai bidang acuan untuk mengukur kemiringan. Jika display berkedip selama prosedur pengukuran berlangsung, berarti posisi alat pengukur terlalu miring ke samping.

Fungsi memori

Nilai atau hasil akhir dari tiap akhir pengukuran akan tersimpan secara otomatis.

Display nilai yang disimpan

Maksimum 50 nilai (nilai pengukuran atau foto dengan nilai pengukuran) dapat diakses.

Pilih fungsi memori dengan softkey (12)

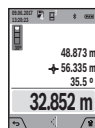

Nomor nilai memori ditampilkan di bagian atas display, sementara nilai memori dan fungsi pengukuran yang berkaitan ditampilkan di bawah

Tekan tombol (4) [+] untuk menggulir ke depan pada nilai yang tersimpan.

Tekan tombol **(11) [-]** untuk menggulir ke belakang pada nilai yang tersimpan.

Jika tidak terdapat nilai pada memori yang tersedia, maka di display akan ditampilkan pada bagian bawah **"0.000"** dan bagian atas **"0"**.

Nilai terlama berada pada posisi 1 di memori, nilai terbaru berada pada posisi 50 (pada 50 nilai memori yang tersedia). Saat menyimpan nilai selanjutnya, maka nilai terlama di memori akan selalu terhapus.

Menghapus memori

Untuk membuka memori, tekan softkey **(12) [■]**. Untuk menghapus nilai pengukuran dalam urutan terbalik, tekan softkey **(3) [■]** sebanyak yang diinginkan. Untuk menghapus seluruh isi memori, tekan softkey **(3) [■]** dan tombol zoom **(5)** secara bersamaan.

Menambah/mengurangi nilai

Nilai ukur atau hasil akhir dapat ditambah atau dikurangi.

Menambah nilai

Contoh berikut ini menggambarkan penambahan luas: Tentukan luas sesuai dengan bagian "Pengukuran luas" (lihat „Pengukuran luas“, Halaman 56).

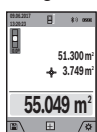

Tekan tombol **(4) [+]**. Simbol dan permukaan yang dihitung **"+"** ditampilkan. Tekan tombol ukur **(2) [▲]** untuk memulai pengukuran luas selanjutnya. Tentukan luas sesuai dengan bagian "Pengukuran luas" (lihat „Pengukuran luas“, Halaman 56). Begitu pengukuran kedua selesai, hasil pengukuran luas kedua akan ditampilkan pada display bagian bawah. Untuk menampilkan hasil akhir, tekan ulang tombol ukur **(2) [▲]**.

Catatan: Pada sebuah pengukuran panjang, hasil akhir akan segera ditampilkan.

Mengurangi nilai

Untuk pengurangan nilai, tekan tombol **(11) [-]**. Prosedur selanjutnya sama dengan "menambahkan nilai pengukuran".

Menghapus nilai atau hasil pengukuran

Dengan menekan sebentar tombol on/off **(9) [⊙]** nilai pengukuran terakhir pada semua fungsi pengukuran dapat dihapus.

Antarmuka *Bluetooth*[®]

Pengiriman data ke perangkat lain

Alat pengukur dilengkapi dengan modul *Bluetooth*[®] dengan teknologi radio yang memungkinkan transfer data ke perangkat seluler tertentu dengan antarmuka *Bluetooth*[®] (misalnya smartphone, tablet).

Informasi mengenai persyaratan sistem yang diperlukan untuk koneksi *Bluetooth*[®] dapat dilihat pada situs internet Bosch di www.bosch-pt.com.

► Informasi lebih lanjut dapat ditemukan di halaman produk Bosch.

Ketika mengirim data melalui *Bluetooth*[®] dapat terjadi penundaan waktu antara perangkat seluler yang terhubung

dan alat pengukur ini. Hal ini dapat disebabkan pada jarak kedua perangkat satu sama lain atau pada objek pengukuran itu sendiri.

Pengaktifan antarmuka *Bluetooth*[®] untuk pengiriman data pada perangkat seluler

Pengaktifan antarmuka *Bluetooth*[®] dilakukan dalam pengaturan. Untuk mengaktifkan sinyal *Bluetooth*[®], tekan tombol **(4) [+]**. Pastikan antarmuka *Bluetooth*[®] telah diaktifkan pada perangkat seluler.

Aplikasi khusus Bosch "Measuring Master" tersedia untuk memperluas cakupan fungsi ponsel dan untuk mempermudah pengelolaan data. Alat tersebut dapat diunduh tergantung perangkat yang ada di store terkait. Setelah mengaktifkan aplikasi Bosch, koneksi antara perangkat seluler dengan alat pengukur akan dibuat. Pilih alat pengukur yang tepat sesuai dengan nomor seri jika beberapa alat pengukur aktif telah ditemukan. Nomor seri **(15)** dapat ditemukan di pelat spesifikasi alat pengukur. Status koneksi serta koneksi yang aktif **(f)** ditampilkan pada display **(1)** alat pengukur.

Penonaktifan antarmuka *Bluetooth*[®]

Penonaktifan koneksi *Bluetooth*[®] dilakukan dalam pengaturan. Untuk menonaktifkan sinyal *Bluetooth*[®], tekan tombol **(11) [-]** atau matikan alat pengukur.

Petunjuk pengoperasian

- Informasi lebih lanjut dapat ditemukan di halaman produk Bosch.
- Alat pengukur dilengkapi dengan antarmuka nirkabel. Perhatikan batasan pengoperasian lokal, misalnya dalam pesawat terbang atau di rumah sakit.

Petunjuk umum

Lensa penerima **(18)**, outlet sinar laser **(19)** dan kamera **(20)** tidak boleh tertutup saat pengukuran.

Alat pengukur tidak boleh digerakkan selama pengukuran. Untuk itu, letakkan sebisa mungkin pada permukaan dudukan atau penopang yang stabil.

Pengaruh terhadap rentang pengukuran

Jangkauan pengukuran tergantung pada kondisi pencahayaan dan karakter pemantulan permukaan target. Untuk visibilitas sinar laser yang lebih baik pada pencahayaan sekitar yang kuat, gunakan kamera terintegrasi **(20)**, kacamata laser **(26)** (aksesori) dan panel target laser **(25)** (aksesori) atau bayangi permukaan target.

Pengaruh terhadap hasil pengukuran

Karena efek fisik, kesalahan pengukuran yang terjadi saat mengukur pada permukaan yang berbeda tidak dapat dihindari. Termasuk:

- permukaan transparan (misalnya kaca, air),
- permukaan yang memantulkan bayangan (misalnya logam yang mengkilap, kaca),

- permukaan berpori (misalnya bahan insulasi)
- permukaan berstruktur (misalnya permukaan plester kasar, batu alam).

Jika perlu, gunakan reflektor (alat pemantulan) sinar laser **(25)** (aksesori) pada permukaan tersebut.

Kesalahan pengukuran juga dapat terjadi jika melihat permukaan target yang miring.

Selain itu, lapisan udara dengan suhu yang berbeda atau pantulan yang diterima secara tidak langsung dapat memengaruhi nilai pengukuran.

Pemeriksaan akurasi dan kalibrasi pengukuran kemiringan (lihat gambar H)

Periksalah secara berkala ketepatan pengukuran kemiringan. Lakukan dengan melakukan pengukuran pembalikan. Untuk melakukannya, letakkan alat pengukur pada meja dan ukur kemiringannya. Putar alat pengukur sebesar 180° dan ukur kembali kemiringan. Perbedaan nilai yang ditampilkan tidak boleh melebihi 0,3°.

Apabila terdapat perbedaan besar, alat pengukur harus dikalibrasi ulang. Untuk itu, pilih  dalam pengaturan. Ikuti petunjuk pada display.

Setelah perubahan suhu yang besar dan setelah mengalami benturan, disarankan agar dilakukan pengujian presisi dan bila perlu kalibrasi alat pengukur. Setelah perubahan suhu, suhu alat pengukur harus disesuaikan beberapa saat sebelum dilakukan kalibrasi.

Pemeriksaan akurasi pada pengukuran jarak

Akurasi alat pengukur dapat diperiksa dengan cara sebagai berikut:

- Pilih satu jarak pengukuran yang tidak berubah-ubah sebesar kira-kira 3 sampai 10 m yang panjangnya diketahui dengan pasti (misalnya lebar ruangan, ukuran pintu). Pengukuran harus dilakukan dalam kondisi yang menguntungkan, yakni rute pengukuran harus berada di dalam ruangan dengan pencahayaan latar belakang yang redup dan permukaan sasaran harus halus serta dapat memantulkan cahaya dengan baik (misalnya dinding yang dicat putih).
- Ukur jarak 10 kali secara berurutan.

Penyimpangan pengukuran tunggal dari nilai rata-rata tidak boleh lebih dari ± 2 mm terhadap total bagian yang diukur pada kondisi yang baik. Catat pengukuran agar ketepatan dapat dibandingkan dengan waktu yang berikutnya.

Pemeriksaan akurasi dan kalibrasi display sasaran (hair cross)

Periksa akurasi orientasi laser dan display sasaran secara rutin.

- Pilih permukaan yang terang dengan pencahayaan seredup mungkin (misalnya dinding putih) pada jarak minimal 5 m sebagai sasaran.
- Periksa apakah titik laser berada di dalam display sasaran pada display.

Jika titik laser tidak berada dalam display sasaran, display sasaran harus dikalibrasi ulang.

Untuk itu, pilih  dalam pengaturan. Ikuti petunjuk pada display.

Pada jarak yang lebih panjang (lebih dari lima meter), penanda sasaran juga akan ditampilkan untuk memberi penanda titik ukur.

Bekerja dengan tripod (aksesori)

Tripod sangat perlu digunakan saat melakukan pengukuran jarak yang lebih jauh. Letakkan alat pengukur dengan ulir 1/4" **(17)** pada pelat tripod **(27)** atau tripod foto biasa. Kencangkan alat pengukur dengan baut pengunci dari pelat tripod.

Atur bidang acuan untuk pengukuran dengan tripod dalam pengaturan (bidang acuan tripod).

Gangguan – Penyebab dan Penyelesaiannya

Penyebab	Solusi
Peringatan suhu berkedip, pengukuran tidak dapat dilakukan	
Alat pengukur berada di luar suhu pengoperasian -10°C hingga $+45^{\circ}\text{C}$ (dalam fungsi pengukuran kontinu hingga $+40^{\circ}\text{C}$).	Tunggu hingga alat pengukur berada pada suhu pengoperasian.
Tampilan "ERROR" pada display	
Menambahkan/mengurangkan nilai pengukuran dengan satuan ukur yang berbeda	Hanya tambah/kurangi nilai pengukuran dengan satuan ukur yang sama.
Sudut antara sinar laser dan target terlalu lancip.	Perbesar sudut antara sinar laser dan target.
Pantulan pada permukaan target terlalu kuat (misalnya cermin) atau terlalu lemah (misalnya bahan berwarna hitam), atau cahaya sekitar terlalu terang.	Menggunakan reflektor sinar laser (25) (aksesori)
Outlet sinar laser (19) , lensa penerima (18) atau kamera (20) berembun (misalnya karena perubahan suhu yang drastis).	Seka outlet sinar laser (19) , lensa penerima (18) atau kamera (20) hingga kering dengan kain lembut
Nilai yang dihitung lebih besar dari 1 999 999 atau lebih kecil dari $-999\,999/\text{m}^2/\text{m}^3$.	Bagi penghitungan ke tahap menengah.
Tampilan "CAL" dan tampilan "ERROR" pada display	
Kalibrasi dari pengukuran kemiringan tidak dilakukan	Ulangi kalibrasi dan ikuti petunjuk pada display dan

Penyebab	Solusi
dalam urutan yang sesuai atau dalam posisi yang tepat.	petunjuk dalam panduan pengoperasian.
Area yang digunakan untuk kalibrasi tidak diarahkan dengan tepat secara mendatar atau tepat tegak lurus.	Ulangi kalibrasi pada permukaan yang mendatar atau tegak lurus dan jika perlu periksa permukaan sebelumnya dengan waterpas.
Saat menekan tombol, alat pengukur bergerak atau terbalik.	Ulangi kalibrasi dan selama menekan tombol, tahan alat pengukur agar tidak bergerak di atas permukaan.

Hasil pengukuran tidak logis

Pantulan pada permukaan target tidak jelas (misalnya air, kaca).	Tutupi permukaan target.
Outlet sinar laser (19) atau lensa penerima (18) atau kamera (20) tertutup.	Jangan menghalangi atau menutupi outlet sinar laser (19), lensa penerima (18) atau kamera (20).
Bidang acuan tidak diatur dengan benar.	Pilih bidang acuan yang sesuai untuk pengukuran.
Terhalangnya jalur sinar laser.	Titik laser harus sepenuhnya berada pada permukaan target.

Bluetooth® tidak dapat diaktifkan

Baterai terlalu lemah.	Mengganti baterai
------------------------	-------------------

Tidak terdapat koneksi Bluetooth®

Gangguan pada koneksi Bluetooth®	Nonaktifkan dan aktifkan kembali Bluetooth® pada alat pengukur dan ponsel dan nyalakan kembali.
	Periksa aplikasi pada perangkat seluler.
	Periksa apakah Bluetooth® pada alat pengukur dan perangkat seluler Anda telah aktif.
	Periksa apakah perangkat seluler mengalami kelebihan beban.
	Perpendek jarak antara alat pengukur dan perangkat seluler.
	Hindari hambatan (misalnya beton bertulang, pintu logam) antara alat pengukur dan perangkat seluler. Jaga jarak dengan sumber gangguan elektromagnetis (misalnya transmitter WLAN).



Alat pengukur menjaga fungsi yang tepat saat setiap kali pengukuran dilakukan. Jika ditemukan kerusakan, display hanya akan menampilkan simbol di sebelumnya. Dalam hal ini, atau jika tindakan penyelesaian telah dilakukan namun kesalahan tidak dapat diperbaiki, lakukan pemeriksaan alat pengukur di Customer Service Bosch dealer Anda.

Perawatan dan servis

Perawatan dan pembersihan

Jaga kebersihan alat.

Jangan memasukkan alat pengukur ke dalam air atau cairan lainnya.

Jika alat kotor, bersihkan dengan lap yang lembut dan lembap. Jangan gunakan bahan pembersih atau zat pelarut. Bersihkan lensa penerima (18), outlet sinar laser (19) dan kamera (20) dengan sangat hati-hati: Pastikan tidak ada kotoran pada lensa penerima, outlet sinar laser dan kamera. Bersihkan lensa penerima, outlet sinar laser dan kamera hanya dengan bahan-bahan yang sesuai untuk kamera. Jangan coba membersihkan kotoran dari lensa penerima, outlet sinar laser atau kamera dengan benda-benda berujung tajam, dan jangan pula diusap (risiko tergores). Saat alat akan dibawa untuk diperbaiki, simpan alat pengukur ke dalam kantong pelindung (23).

Layanan pelanggan dan konsultasi penggunaan

Layanan pelanggan Bosch menjawab semua pertanyaan Anda tentang reparasi dan perawatan serta tentang suku cadang produk ini. Gambaran teknis (exploded view) dan informasi mengenai suku cadang dapat ditemukan di:

www.bosch-pt.com

Tim konsultasi penggunaan Bosch akan membantu Anda menjawab pertanyaan seputar produk kami beserta aksesorinya.

Jika Anda hendak menanyakan sesuatu atau memesan suku cadang, selalu sebutkan nomor model yang terdiri dari 10 angka dan tercantum pada label tipe produk.

Indonesia

PT Robert Bosch
Palma Tower 10th Floor
Jalan RA Kartini II-S Kaveling 6
Pondok Pinang, Kebayoran Lama
Jakarta Selatan 12310
Tel.: (021) 3005 5800
Fax: (021) 3005 5801
E-Mail: boschpowertools@id.bosch.com
www.bosch-pt.co.id

Cara membuang

Alat ukur, aksesoris, dan kemasan harus didaur ulang dengan cara yang ramah lingkungan.



Jangan membuang alat ukur dan baterai bersama dengan sampah rumah tangga!

Tiếng Việt

Hướng dẫn an toàn



Phải đọc và chú ý mọi hướng dẫn để đảm bảo an toàn và không bị nguy hiểm khi làm việc với dụng cụ đo.

Khi sử dụng dụng cụ đo không phù hợp với các hướng dẫn ở trên, các thiết bị bảo vệ được tích hợp trong dụng cụ đo có thể bị suy giảm. Không bao giờ được làm cho các dấu hiệu cảnh báo trên dụng cụ đo không thể đọc được. **HÃY BẢO QUẢN CẨN THẬN CÁC HƯỚNG DẪN NÀY VÀ ĐƯA KÈM THEO KHI BẠN CHUYỂN GIAO DỤNG CỤ ĐO.**

- ▶ **Thận trọng** - nếu những thiết bị khác ngoài thiết bị hiệu chỉnh hoặc thiết bị điều khiển được nêu ở đây được sử dụng hoặc các phương pháp khác được tiến hành, có thể dẫn đến phơi nhiễm phóng xạ nguy hiểm.
- ▶ Máy đo được dán nhãn cảnh báo (được đánh dấu trong mô tả máy đo ở trang đồ thị).
- ▶ Nếu văn bản của nhãn cảnh báo không theo ngôn ngữ của bạn, hãy dán chống nhãn dính được cung cấp kèm theo bằng ngôn ngữ của nước bạn lên trên trước khi sử dụng lần đầu tiên.



Không được hướng tia laser vào người hoặc động vật và không được nhìn vào tia laser trực tiếp hoặc phản xạ. Bởi vì bạn có thể chiếu lóa mắt người, gây tai nạn hoặc gây hỏng mắt.

- ▶ Nếu tia laser hướng vào mắt, bạn phải nhắm mắt lại và ngay lập tức xoay đầu để tránh tia laser.
- ▶ Không thực hiện bất kỳ thay đổi nào ở thiết bị laser.
- ▶ Không sử dụng kính nhìn tia laser làm kính bảo vệ. Kính nhìn tia laser dùng để nhận biết tốt hơn tia laser; tuy nhiên nó không bảo vệ khỏi tia laser.
- ▶ Không sử dụng kính nhìn tia laser làm kính mát hoặc trong giao thông đường bộ. Kính nhìn tia laser không chống UV hoàn toàn và giảm thiểu thụ cảm màu sắc.
- ▶ Chỉ để người có chuyên môn được đào tạo sửa dụng cụ đo và chỉ dùng các phụ tùng gốc để sửa chữa. Điều này đảm bảo cho sự an toàn của dụng cụ đo được giữ nguyên.

- ▶ **Không để trẻ em sử dụng dụng cụ đo laser khi không có người lớn giám sát.** Bạn có thể vô tình làm lóa mắt người khác.
- ▶ **Không làm việc với dụng cụ đo trong môi trường dễ nổ, mà trong đó có chất lỏng, khí ga hoặc bụi dễ cháy.** Các tia lửa có thể hình thành trong dụng cụ đo và có khả năng làm rác cháy hay ngùn khói.
- ▶ **Cẩn thận!** Nếu sử dụng máy đo với cổng Bluetooth® có thể gây nhiễu các dụng cụ, thiết bị khác cũng như máy bay và dụng cụ y tế (ví dụ: máy tạo nhịp tim, máy trợ thính). Và cũng không thể loại trừ hoàn toàn những tổn hại cho người và động vật ở môi trường trực diện xung quanh. Không sử dụng máy đo có kết nối Bluetooth® ở gần những thiết bị y tế, trạm xăng, cơ sở hóa học, các khu vực có nguy cơ gây nổ và các khu vực cháy nổ. Không sử dụng máy đo có kết nối Bluetooth® trên máy bay. Tránh để máy hoạt động gần cơ thể trong thời gian dài.

Bluetooth® có biểu tượng chữ và biểu tượng ảnh (các logo) do công ty cổ phần Bluetooth SIG đăng ký thương hiệu và sở hữu. Công ty trách nhiệm hữu hạn Robert Bosch Power Tools GmbH đã được cấp phép để sử dụng những biểu tượng chữ/biểu tượng ảnh này với sản phẩm của mình.

Mô Tả Sản Phẩm và Đặc Tính Kỹ Thuật

Xin lưu ý các hình minh hoạt trong phần trước của hướng dẫn vận hành.

Sử dụng đúng cách

Dụng cụ đo lường được thiết kế để đo độ xa, độ dài, chiều cao, khoảng cách, độ nghiêng và để tính toán diện tích và thể tích.

Kết quả đo có thể được gửi qua Bluetooth® đến các thiết bị khác.

Dụng cụ đo phù hợp để sử dụng trong vùng bên ngoài và bên trong.

Các bộ phận được minh họa

Sự đánh số các biểu trưng của sản phẩm là để tham khảo hình minh họa dụng cụ đo trên trang hình ảnh.

- (1) Hiển thị
- (2) Nút đo [▲] (có thể sử dụng phía trước hoặc phía bên)
- (3) Nút bấm mềm [■]
- (4) Nút cộng [+]/Chọn sang bên phải
- (5) Nút thu phóng
- (6) Thiết bị lắp vòng treo
- (7) Núm nhà chốt đo

- (8) Chốt đo
- (9) Nút xóa Bật-Tắt [⏻]
- (10) Nút hiển thị đích
- (11) Nút trừ [-] / Chọn sang bên trái
- (12) Nút bấm mềm [■]
- (13) Nút chức năng [Func]
- (14) Nhấn cảnh báo laser
- (15) Mã seri sản xuất
- (16) Nắp đậy pin
- (17) 1/4"-Lỗ cắm giá ba chân
- (18) Thấu kính
- (19) Lỗ chiếu luồng laze
- (20) Camera
- (21) Nắp vặn
- (22) Các pin
- (23) Túi xách bảo vệ
- (24) Vòng treo
- (25) Bảng đối tượng của tia laser ^{A)}
- (26) Kính nhìn tia laser ^{A)}
- (27) Giá đỡ ba chân ^{A)}

A) Phụ tùng được trình bày hay mô tả không phải là một phần của tiêu chuẩn hàng hóa được giao kèm theo sản phẩm. Bạn có thể tham khảo tổng thể các loại phụ tùng, phụ kiện trong chương trình phụ tùng của chúng tôi.

Hiển thị các Phần tử

- (a) Hàng kết quả
- (b) Nút hiển thị đích (Đường chữ thập)
- (c) Hiển thị góc nghiêng
- (d) Ngày/Giờ
- (e) Điểm xuất phát đo chuẩn
- (f) Trạng thái kết nối
 -  Bluetooth® không được kích hoạt
 -  Kích hoạt, tạo kết nối Bluetooth®
- (g) Hiển thị mức sạc ắc quy
- (h) Các hàng giá trị đo được
- (i) Các cài đặt mạng (Nút bấm mềm)
- (j) Chức năng đo được chọn
- (k) Bộ nhớ bên trong (Nút bấm mềm)
- (l) Chức năng trợ giúp được tích hợp (Nút bấm mềm)
- (m) Trờ lại (Nút bấm mềm)
- (n) Màn hình khởi động (Nút bấm mềm)
- (o) Các cài đặt thiết bị

Thông số kỹ thuật

Máy định tâm laser kỹ thuật số	GLM 150 C
Mã số máy	3 601 K72 F..
Biên độ đo (chung)	0,08–150 m ^{A)}
Biên độ đo (chung, cho những điều kiện đo khó)	0,08–60 m ^{B)}
Độ đo chính xác (tiêu biểu)	±1,5 mm ^{A)}
Độ chính xác khi đo (chung, cho những điều kiện đo khó)	±3,0 mm ^{B)}
Đơn vị biểu thị thấp nhất	0,5 mm
Đo Gián Tiếp Khoảng Cách và bọt thủy	
Phạm vi đo	0°–360° (4x90°)
Đo độ dốc	
Phạm vi đo	0°–360° (4x90°)
Độ đo chính xác (tiêu biểu)	±0,2° ^{C) D) E)}
Đơn vị biểu thị thấp nhất	0,1°
Giới thiệu chung	
Nhiệt độ hoạt động	-10 °C ... +45 °C ^{F)}
Nhiệt độ lưu kho	-20 °C ... +70 °C
Giới hạn của nhiệt độ nạp điện cho phép	+5 °C ... +40 °C
Độ ẩm không khí tương đối tối đa.	90 %
Chiều cao ứng dụng tối đa qua chiều cao tham chiếu	2000 m
Mức độ bắn theo IEC 61010-1	2 ^{G)}
Cấp độ laser	2
Loại laser	650 nm, < 1 mW
Đường kính chùm tia laser (ở 25 °C) khoảng	
– khoảng cách 10 m	9 mm
– khoảng cách 100 m	90 mm
Tắt tự động sau khoảng.	
– Laser	20 s
– Dụng cụ đo (không đo)	5 phút ^{H)}
Các pin	3 x 1,5 V LR6 (AA)
Trọng lượng theo Qui trình EPTA-Procedure 01:2014	0,23 kg
Khối lượng	142 (176) x 64 x 28 mm

Máy định tâm laser kỹ thuật số GLM 150 C

Mức độ bảo vệ	IP 54 (được bảo vệ chống bụi và tia nước)
---------------	---

Truyền dữ liệu

Bluetooth®	Bluetooth® (4.2 low-energy) ¹⁾
Dải tần số hoạt động	2402 – 2480 MHz
Công suất phát tối đa	8 mW

- A) Đo từ mép phía trước của dụng cụ đo, áp dụng cho mục tiêu có khả năng phản xạ cao (ví dụ như một bức tường sơn trắng), ánh sáng nền yếu và nhiệt độ làm việc là 25 °C. Thêm vào đó cần tính tới một mức sai lệch khoảng ± 0,05 mm/m.
- B) Đo từ mép phía trước của dụng cụ đo, áp dụng cho mục tiêu có khả năng phản xạ cao (ví dụ như một bức tường sơn trắng) và ánh sáng nền mạnh. Thêm vào đó cần tính tới một mức sai lệch khoảng ± 0,15 mm/m.
- C) Sau khi hiệu chỉnh ở 0° và 90°. Lỗi độ nghiêng bổ sung từ tối đa ±0,01 °/độ đến 45°. Độ chính xác do có liên quan đến ba hướng hiệu chỉnh đo độ nghiêng, xem hình H.
- D) Ở nhiệt độ hoạt động 25 °C
- E) Cạnh trái của dụng cụ đo được dùng làm mặt phẳng tham chiếu để đo độ nghiêng.
- F) Trong chức năng Đo liên tục, nhiệt độ hoạt động tối đa là +40 °C.
- G) Chỉ có chất bẩn không dẫn xuất hiện, nhưng đôi khi độ dẫn điện tạm thời gây ra do ngưng tụ
- H) Thời gian tắt tự động có thể cài đặt (2, 5, 10 phút hoặc không bao giờ).
- I) Với các thiết bị Bluetooth® tiêu thụ năng lượng thấp, tùy thuộc vào model và hệ điều hành, có thể không cần các thiết lập kết nối. Các thiết bị Bluetooth® phải có tính năng hỗ trợ GATT profile.

Số xêri (15) đều được ghi trên nhãn mác, để dễ dàng nhận dạng loại máy đo.

Sự lắp vào

Lắp/thay ắc quy

Khuyến nghị sử dụng các pin kiểm mangan để vận hành dụng cụ đo.

- Nhấn núm nhà (7) và mở chốt đo (8) khoảng 180°.
- Để mở nắp đậy ngăn pin (16) hãy gấp nắp vận (21) hướng lên trên và vận nó một phần tư vòng ngược chiều kim đồng hồ. Hãy kéo nắp đậy ngăn pin lên ở nắp vận. Lắp pin vào. Xin hãy lưu ý lắp tương ứng đúng cực pin như được thể hiện mặt trong ngăn chứa pin.
- ▶ **Thảo ắc quy ra khỏi dụng cụ đo nếu bạn không muốn sử dụng thiết bị trong thời gian dài.** Pin có thể hư mòn sau thời gian bảo quản lâu và tự xả điện.
- ▶ **Hướng dẫn:** TrackMyTools chỉ khả thi với các pin được gắn.

Vận Hành

Bắt Đầu Vận Hành

- ▶ **Không cho phép dụng cụ đo đang bật một cách không kiểm soát và hãy tắt dụng cụ đo sau khi sử dụng.** Tia Laser có thể chiếu vào những người khác.
- ▶ **Bảo vệ dụng cụ đo tránh khỏi ẩm ướt và không để bức xạ mặt trời chiếu trực tiếp vào.**
- ▶ **Không cho dụng cụ đo tiếp xúc với nhiệt độ khắc nghiệt hoặc dao động nhiệt độ.** Không để nó trong chế độ tự động quá lâu. Điều chỉnh nhiệt độ cho dụng cụ đo khi có sự dao động nhiệt độ lớn, trước khi bạn đưa nó vào vận hành. Trong trường hợp ở trạng thái nhiệt độ cực độ hay nhiệt độ thay đổi thái quá, sự chính xác của dụng cụ đo có thể bị hư hỏng.
- ▶ **Tránh va chạm mạnh hoặc làm rơi dụng cụ đo.** Sau khi có tác động mạnh từ bên ngoài lên dụng cụ đo, cần tiến hành kiểm tra độ chính xác trước khi tiếp tục (xem „Kiểm tra độ chính xác của việc đo khoảng cách“, Trang 69).
- ▶ **Máy đo được trang bị một giao diện sóng vô tuyến. Hãy chú ý các giới hạn địa điểm hoạt động ví dụ như trên máy bay hoặc bệnh viện.**

Bật Mở và Tắt

Khi làm việc, hãy chú ý rằng ống kính thu (18), đầu ra tia laser (19) và camera (20) không bị khóa hoặc ẩn sẽ không thể cho các phép đo chính xác.

- Để **bật** dụng cụ đo và Laser hãy nhấn nút đo phía trước hoặc bên cạnh (2) [▲].
- Để **Bật** dụng cụ đo mà không bật Laser hãy nhấn nút Xóa Bật-Tắt (9) [○].

- ▶ **Không được chia luồng laser vào con người hay động vật và không được tự chính bạn nhìn vào luồng laser, ngay cả khi từ một khoảng cách lớn.**

Để **tắt** Laser hãy nhấn nhanh nút Xóa Bật-Tắt (9) [○].

Để **Tắt** camera, bạn hãy ấn nút hiển thị đích (10). Để **Tắt** dụng cụ đo hãy nhấn giữ nút Xóa Bật-Tắt (9) [○].

Khi tắt dụng cụ đo, các giá trị và các thiết lập thiết bị hiện có trong bộ nhớ sẽ được giữ lại.

Camera

Khi bật dụng cụ đo lần đầu, Camera (20) được bật tự động. Để tắt, bạn hãy ấn nút hiển thị đích (10). Cài đặt của camera (bật/tắt) sẽ được lưu khi tắt dụng cụ đo.

Tối ưu hóa độ rõ của điểm laser

Khi dùng dụng cụ đo, đặc biệt là ở ngoài trời, dưới ánh nắng mặt trời cũng như ở khoảng cách dài ở phía bên trong, điểm laser có thể không thấy rõ. Độ

rõ của điểm laser/dịch đo có thể được cải thiện ngoài việc bật bổ sung camera bằng:

- Cài đặt độ sáng hiển thị (Các cài đặt thiết bị)
- Sử dụng thu phóng bằng nút (5).

Quy trình đo

Sau khi bật lên, dụng cụ đo ở chế độ đo độ dài. Để dùng chức năng đo khác hãy nhấn nút (13) [Func]. Hãy chọn chức năng đo mong muốn bằng nút (4) [+] hoặc nút (11) [-] từ . Kích hoạt chức năng đo bằng nút (13) [Func] hoặc bằng nút do (2) [▲].

Mép phía sau của dụng cụ đo được chọn làm mức tham chiếu để đo sau khi bật. Để thay đổi mặt phẳng tham chiếu (xem „Chọn mặt phẳng tham chiếu (xem hình A)“, Trang 64). Đặt dụng cụ đo ở điểm đầu tiên muốn đo (ví dụ như bức tường).

Hướng dẫn: Nếu đã bật dụng cụ đo bằng nút Xóa Bật-Tắt (9) [⏻] bạn ấn nhanh nút do (2) [▲] để bật laze.

Ấn nhanh vào nút do để thực hiện phép đo (2) [▲]. Sau đó, chùm tia laser sẽ tắt. Đối với phép đo tiếp theo hãy lặp lại quy trình này.

Khi tia lasere cố định được bật và trong chức năng đo liên tục, phép đo bắt đầu sau lần nhấn đầu tiên lên nút do (2) [▲].

- ▶ **Không được chia luồng laze vào con người hay động vật và không được tự chính bạn nhìn vào luồng laze, ngay cả khi từ một khoảng cách lớn.**

Hướng dẫn: Giá trị đo thường xuất hiện trong vòng 0,5 giây và chậm nhất sau khoảng 4 giây. Thời gian đo phụ thuộc vào độ xa, tình trạng ánh sáng và đặc tính phản xạ ánh sáng của bề mặt đối tượng. Sau khi kết thúc phép đo, chùm tia laser sẽ tự động tắt. Tia laser cố định đã bật sẽ không được ngắt sau khi đo .

Chọn mặt phẳng tham chiếu (xem hình A)

Để đo, bạn có thể chọn lựa giữa bốn mặt phẳng qui chiếu:

- mép trước của dụng cụ đo (ví dụ ví dụ khi áp dụng ở tường),
- đỉnh của chốt đo được gập 180° (8) (ví dụ dành cho các phép đo góc),
- mép trước của dụng cụ đo (ví dụ khi đo từ một cạnh bàn),
- phần giữa của ren (17) (ví dụ đo bằng giá ba chân)

Gấp vào và gập ra chốt do (8) khoảng 180° sẽ được nhận diện tự động và mặt phẳng tham chiếu tương ứng sẽ được gọi ý. Hãy xác nhận điều chỉnh bằng nút do (2) [▲].

Bằng nút bấm mềm hãy chọn (3) [■] Các cài đặt của dụng cụ đo. Chọn mặt phẳng tham chiếu bằng

nút (4) [+] hoặc nút (11) [-] và xác nhận bằng nút (13) [Func].

Sau mỗi lần bật dụng cụ đo, mép sau của dụng cụ đo sẽ được thiết lập sẵn tự động làm mặt phẳng tham chiếu.

Tia laser cố định

Bạn có thể chuyển dụng cụ đo thành tia laser cố định nếu cần. Muốn vậy, bằng nút bấm mềm hãy chọn (3) [■] Các cài đặt của dụng cụ đo. Chọn tia laser cố định bằng nút (4) [+] hoặc nút (11) [-] và xác nhận bằng nút (13) [Func].

- ▶ **Không được chia luồng laze vào con người hay động vật và không được tự chính bạn nhìn vào luồng laze, ngay cả khi từ một khoảng cách lớn.**

Trong cài đặt này, tia laser vẫn được bật giữa các phép đo, để đo thì chỉ cần nhấn nhanh một lần nút do (2) [▲].

Việc ngắt tia laser cố định được thực hiện lại trong các cài đặt hoặc tự động khi tắt dụng cụ đo.

Menu „Các cài đặt“

Để đi đến Menu „Các thiết lập“ (i), hãy nhấn nhanh nút bấm mềm (3) [■] hoặc nhấn giữ nút (13) [Func].

Chọn cài đặt mong muốn bằng nút (4) [+] hoặc nút (11) [-] và xác nhận bằng nút (13) [Func]. Hãy chọn cài đặt mong muốn.

Để thoát khỏi Menu các cài đặt hãy nhấn nút Xóa Bật-Tắt (9) [⏻] hoặc nút bấm mềm (12) [■].

Sắp Đặt



	Bluetooth®
	Mặt phẳng tham chiếu
	Chức năng đồng hồ bấm giờ
	Tia laser cố định
	Hiệu chỉnh phép đo độ nghiêng
	Hiệu chỉnh hiển thị dịch
	Các cài đặt thiết bị

Chức năng đồng hồ bấm giờ

Chức năng đồng hồ bấm giờ sẽ hỗ trợ khi đo ở những vị trí khó tiếp cận hoặc khi các chuyển động của dụng cụ đo bị cản trở trong quá trình đo.

Lựa chọn chức năng đồng hồ bấm giờ trong các cài đặt. Chọn khoảng thời gian mong muốn từ lúc kích hoạt cho tới lúc đo và xác nhận bằng nút (2) [▲] hoặc nút (13) [Func].

Nhấn nút do (2) [▲], để bật tia laser và xem điểm đến. Nhấn lại nút do (2) [▲] để kích hoạt đo. Thực hiện đo sau khoảng thời gian mong muốn. Giá trị đo được hiển thị trong dòng kết quả (a).

Trong thanh trạng thái bên trên có hiển thị khoảng thời gian từ lúc kích hoạt đến lúc đo.

Không thể đo liên tục cũng như đo tối thiểu/đo tối đa ở chức năng đồng hồ bấm giờ đã cài.

Đồng hồ bấm giờ vẫn được cài đến khi tắt dụng cụ đo hoặc tới khi đồng hồ bấm giờ trong menu „Các cài đặt“ được tắt.

Menu „Các cài đặt thiết bị“

Lựa chọn menu „Các cài đặt thiết bị“ trong menu „Các cài đặt“.

Chọn cài đặt thiết bị mong muốn bằng nút (4) [+] hoặc nút (11) [-] và xác nhận bằng nút (13) [Func]. Hãy chọn cài đặt thiết bị mong muốn.

Để thoát khỏi Menu „Các cài đặt thiết bị“ (o) hãy nhấn nút Xóa Bật-tắt (9) [OFF] hoặc nút bấm mềm (12) [M].

Các cài đặt thiết bị

	Ngôn ngữ
	Thời gian & Ngày tháng
	Đơn vị đo lường
	Đơn vị góc
	TrackMyTools
	Thông tin thiết bị
	Tín hiệu âm thanh
	Thời gian tắt
	Dụng cụ chỉnh độ sáng
	Độ sáng màn hình thị
	Căn chỉnh màn hình thị

Cài đặt ngôn ngữ

Lựa chọn „Ngôn ngữ“ trong các cài đặt thiết bị. Hãy cài đặt ngôn ngữ mong muốn và xác nhận bằng nút (13) [Func] hoặc nút đo (2) [▲].

Cài đặt ngày và giờ

Lựa chọn „Ngày & giờ“ trong các cài đặt thiết bị. Hãy cài đặt ngày và giờ theo các chỉ dẫn trên màn hình thị và xác nhận bằng nút bấm mềm (12) [M].

Hướng dẫn: Ngày và giờ phải được cài đặt lại sau khi thay pin.

Thay Đổi Đơn Vị Đo Lường

Lựa chọn „Đơn vị đo“ trong các cài đặt thiết bị. Thiết lập ban đầu là đơn vị đo „m“ (Meter). Hãy cài đặt đơn vị đo mong muốn và xác nhận bằng nút (13) [Func].

Để thoát khỏi Menu hãy nhấn nút Xóa Bật-tắt (9) [OFF] hoặc nút bấm mềm (3) [M]. Sau khi tắt dụng cụ đo, cài đặt thiết bị đã chọn sẽ được lưu lại.

Thay đơn vị góc

Lựa chọn „Đơn vị góc“ trong các cài đặt thiết bị. Thiết lập cơ bản là đơn vị góc „°“ (độ).

Hãy cài đặt đơn vị góc mong muốn và xác nhận bằng nút (13) [Func].

Để thoát khỏi Menu hãy nhấn nút Xóa Bật-tắt (9) [OFF] hoặc nút bấm mềm (3) [M]. Sau khi tắt dụng cụ đo, cài đặt thiết bị đã chọn sẽ được lưu lại.

TrackMyTools

Lựa chọn „TrackMyTools“ trong các cài đặt thiết bị. Hãy xác nhận điều chỉnh bằng nút (13) [Func].

Kích hoạt lần đầu là cần thiết. Chỉ có thể truyền dữ liệu với ứng dụng tương ứng hoặc chương trình PC tương ứng.

TrackMyTools có thể bị bỏ kích hoạt bất cứ lúc nào.

Cài đặt của TrackMyTools (được kích hoạt/bỏ kích hoạt) sẽ được lưu khi tắt dụng cụ đo.

Hướng dẫn: TrackMyTools chỉ khả thi với các pin được gắn. Để kích hoạt TrackMyTools sau khi thay pin phải bật nhanh dụng cụ đo.

Hiển thị Ánh Sáng

Lựa chọn „Dụng cụ chỉnh độ sáng“ trong các cài đặt thiết bị.

Đèn chiếu sáng màn hình sẽ sáng liên tục. Nếu không có nút nào được ấn, đèn chiếu sáng màn hình sẽ mờ đi sau khoảng 30 giây để tiết kiệm pin. Thời gian cho lúc khởi động làm mờ có thể cài đặt được (Các cài đặt thiết bị).

Độ sáng của màn hình hiển thị được điều chỉnh theo nhiều cấp để phù hợp với các điều kiện xung quanh (Các cài đặt thiết bị).

Các chức năng đo

Hướng dẫn: Chức năng trợ giúp được tích hợp

Trong dụng cụ đo, một trợ giúp được lưu dưới dạng hoạt ảnh cho mỗi chức năng đo. Do đó hãy chọn nút (13) [Func], các nút (4) [+] hoặc (11) [-] và sau đó chọn nút bấm mềm (3) [M]. Hoạt ảnh cho bạn biết biện pháp chi tiết của chức năng đo được chọn.

Hoạt ảnh có thể được dừng bằng (3) [M] và được khởi động lại vào bất cứ lúc nào. Bạn có thể cuộn tiến và lùi bằng nút (4) [+] hoặc (11) [-].

Đo Chiều Dài

Hãy chọn phép đo độ dài —I—.

Ấn nhanh vào nút đo để bật chùm tia laser (2) [▲]. Bạn hãy ấn nhanh vào nút đo (2) [▲]. Trị số đo được trình hiện ở bên dưới màn hình thị.

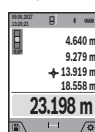

Lặp lại bước trên với mỗi phép đo tiếp theo. Giá trị đo cuối cùng sẽ hiện ở góc dưới trong màn hình hiển thị, giá trị đo áp chót như trên.

Đo liên tục

Khi đo liên tục, dụng cụ đo có thể chuyển động tương đối đến đích, khi đó giá trị đo được cập nhật cứ 0,5 s một lần. Ví dụ bạn có thể đứng cách tường tới khoảng cách mong muốn, khoảng cách hiện tại luôn dễ đọc.

Hãy chọn phép đo độ dài --- .

Ấn nhanh vào nút đo để bật chùm tia laser (2) \blacktriangle .

Di chuyển dụng cụ đo cho đến khi trị số của khoảng cách yêu cầu được trình hiện ở bên dưới màn hình thị.

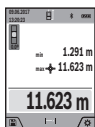

Bằng cách nhấn nút đo (2) \blacktriangle bạn sẽ ngừng phép đo liên tục. Giá trị đo hiện tại sẽ được hiển thị ở góc dưới trong màn hình hiển thị. Giá trị đo tối thiểu và tối đa như trên. Nhấn lại nút đo (2) \blacktriangle phép đo liên tục sẽ bắt đầu lại.

Phép đo liên tục được tự động tắt sau 5 phút.

Đo Diện Tích

Chọn phép đo diện tích \square .

Sau đó, bạn hãy đo chiều rộng và chiều dài liên tiếp như khi đo chiều dài. Giữa hai phép đo vẫn bật chùm tia laser. Khoảng cách đã đo nhấp nháy trong thiết bị hiển thị đo diện tích \square (Xem phần tử hiển thị (j)).



Giá trị đo đầu tiên được hiển thị ở góc trên trong màn hình hiển thị.

Sau khi kết thúc lần đo thứ hai phần diện tích sẽ được tính và hiển thị tự động. Kết quả sẽ hiển thị ở góc dưới trong màn hình hiển thị, đơn vị đo như

trên.

Đo khối lượng

Chọn đo thể tích \square .

Sau đó, bạn hãy đo chiều rộng, chiều dài và chiều sâu liên tiếp như khi đo chiều dài. Giữa ba phép đo vẫn bật chùm tia laser. Khoảng cách đã đo nhấp nháy trong thiết bị hiển thị đo thể tích \square (Xem phần tử hiển thị (j)).



Giá trị đo đầu tiên được hiển thị ở góc trên trong màn hình hiển thị.

Sau khi thực hiện việc đo lần thứ ba, khối lượng được tự động tính toán và hiển thị. Kết quả sẽ hiển thị ở góc dưới trong màn hình hiển thị, đơn vị đo như

trên.

Đo Góc Tiếp Khoảng Cách

Hãy chọn phép đo khoảng cách gián tiếp \sphericalangle . Để đo khoảng cách gián tiếp, phải có sẵn bốn chức năng đo, mà qua đó các khoảng cách khác nhau có thể được xác định trong mỗi trường hợp.

Đo gián tiếp khoảng cách được sử dụng để đo khoảng cách mà ta không thể đo trực tiếp được do có vật cản trở ngăn cản luồng laze, hoặc đo không có bề mặt mục tiêu sẵn có nào được sử dụng như

là vật phản chiếu. Qui trình đo này chỉ có thể sử dụng trong chiều thẳng đứng. Bất cứ sự lệch hướng nào ở chiều ngang cũng sẽ gây ra sự đo sai.

Hướng dẫn: Việc đo khoảng cách gián tiếp sẽ luôn đưa kết quả không chính xác bằng việc đo trực tiếp. Tùy các điều kiện áp dụng, xác suất lỗi đo có thể lớn hơn khi đo khoảng cách trực tiếp. Để cải thiện độ chính xác trong khi đo, nên sử dụng giá đỡ ba chân (phụ tùng). Luồng laze duy trì ở trạng thái mở giữa các lần đo riêng lẻ

a) Đo chiều cao gián tiếp (xem hình B)

Hãy chọn phép đo chiều cao gián tiếp \sphericalangle

Hãy lưu ý dụng cụ đo được định vị ở cùng một chiều cao như điểm đo đáy. Nghiêng dụng cụ đo quanh mặt phẳng tham chiếu và đo khoảng cách như khi đo chiều dài „1“ (được hiển thị trong màn hình hiển thị dạng vạch màu đỏ).

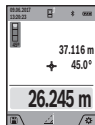

Sau khi kết thúc đo, kết quả của đoạn đường đã tìm kiếm „X“ được hiển thị trong dòng kết quả (a). Giá trị đo của đoạn đường „1“ và góc „ α “ ở trong các hàng giá trị đo được (h).

b) Đo chiều cao gián tiếp kép (xem hình C)

Dụng cụ đo có thể đo gián tiếp tất cả các khoảng cách, mà nằm trong mặt phẳng thẳng đứng của dụng cụ đo. Hãy chọn phép đo chiều cao kép gián tiếp \sphericalangle . Hãy đo khoảng cách „1“ và „2“ theo trình tự này như khi đo chiều dài.

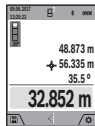

Sau khi kết thúc đo, kết quả của đoạn đường đã tìm kiếm „X“ được hiển thị trong dòng kết quả (a). Giá trị đo của đoạn đường „1“, „2“ và góc „ α “ ở trong các hàng giá trị đo được (h).

Hãy lưu ý rằng mặt phẳng tham chiếu của phép đo (ví dụ mép sau của dụng cụ đo) phải ở chính xác cùng một vị trí ở tất cả các lần đo riêng lẻ trong quá trình đo.

c) Đo chiều dài gián tiếp (xem hình D)

Chọn phép đo chiều dài gián tiếp \sphericalangle .

Hãy lưu ý dụng cụ đo được định vị ở cùng một chiều cao như cách tìm điểm đo. Nghiêng dụng cụ đo quanh mặt phẳng tham chiếu và đo khoảng cách „1“ như khi đo chiều dài.

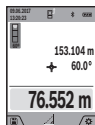

Sau khi kết thúc đo, kết quả của đoạn đường đã tìm kiếm „X“ được hiển thị trong dòng kết quả (a). Giá trị đo của đoạn đường „1“ và góc „ α “ ở trong các hàng giá trị đo được (h).

d) Phép đo hình thang (xem Hình E)

Phép đo hình thang có thể được sử dụng để xác định chiều dài của dốc mái.

Chọn đo hình thang \square .

Hãy đo khoảng cách „1“, „2“ và „3“ theo trình tự này như khi đo chiều dài. Hãy lưu ý rằng phép đo

đoạn đường „3“ bắt đầu chính xác vào điểm cuối của đoạn đường „1“ và ở giữa đoạn đường „1“ và „2“ cũng như giữa „1“ và „3“ có một góc bên phải.

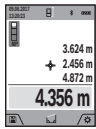

Sau khi hoàn thành phép đo cuối cùng, kết quả của khoảng cách đã tìm „X“ sẽ được hiển thị trong dòng kết quả (a). Các đơn vị đo ở trong hàng giá trị đo được (h).

Đo bề mặt tường (xem hình F)

Đo bề mặt tường được sử dụng để xác định tổng số của một số bề mặt riêng lẻ có cùng một chiều cao. Trong ví dụ minh họa, tổng diện tích của nhiều bức tường được xác định, trong đó có chiều cao phòng giống nhau H, nhưng các chiều dài khác nhau L.

Chọn phép đo diện tích tường

Đo chiều cao phòng H như đo chiều dài. Giá trị đo được hiển thị trong dòng giá trị đo phía trên. Laser vẫn bật.

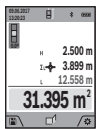

Sau đó đo chiều dài L₁ của bức tường thứ nhất. Diện tích được tính toán tự động và được hiển thị trong dòng kết quả (a). Giá trị đo chiều dài cuối cùng xuất hiện ở dòng giá trị đo dưới (h). Laser vẫn bật.

Đo chiều dài L₂ của bức tường thứ hai. Đơn vị đo hiển thị trong dòng giá trị đo (h) sẽ được cộng thêm vào chiều dài L₁. Tổng hai chiều dài (được hiển thị trong dòng giá trị đo ở giữa (h)) sẽ được nhân với chiều cao đã lưu H. Tổng giá trị diện tích được hiển thị trong dòng kết quả (a).

Bạn có thể tùy ý đo nhiều chiều dài tiếp theo L_x mà tự động được cộng thêm vào và được nhân với chiều cao H. Điều kiện để tính toán đúng diện tích, là chiều dài đã đo đầu tiên (trong ví dụ chiều cao phòng H) phải đồng nhất đối với tất cả các phần diện tích.

Chức năng khoan cọc (xem hình G)

Chức năng khoan cọc sẽ đo lại nhiều lần chiều dài xác định (khoảng cách). Những chiều dài này có thể được chuyển thành bề mặt, để cho phép cắt nguyên liệu thành miếng dài bằng nhau hoặc tạo các tường ngăn phụ dạng vách thạch cao. Chiều dài tối thiểu có thể thiết lập là 0,1 m, chiều dài tối đa là 50 m.

Hướng dẫn: Khoảng cách tới đánh dấu trong màn hình hiển thị được hiển thị trong chức năng phân ra. Điểm tham chiếu **không** phải là cạnh của dụng cụ đo.

Hãy chọn chức năng khoan cọc

Thiết lập chiều dài mong muốn bằng nút (4) [+]
hoặc nút (11) [-].

Khởi động chức năng khoan cọc bằng cách nhấn nút đo (2) , và từ từ dịch ra xa nút điểm khởi đầu.



Dụng cụ đo tiếp tục đo khoảng cách tới điểm khởi đầu. Khi đó chiều dài xác định cũng như giá trị đo hiện tại sẽ được hiển thị. Các mũi tên trên và dưới cho thấy khoảng cách nhỏ nhất đến ký hiệu đánh dấu kế tiếp hoặc trước đó.

Hướng dẫn: Khi tiếp tục đo bạn có thể đặt một giá trị đo được làm chiều dài xác định bằng cách nhấn và giữ nút đo (2) .



Hệ số bên trái chỉ ra chiều dài xác định đã đạt được bao nhiêu lần. Các mũi tên màu xanh lá ở hai bên của màn hình hiển thị cho biết chiều dài đạt được cho mục đích đánh dấu.

Các mũi tên đỏ hoặc nhãn màu đỏ hiển thị giá trị thực, nếu giá trị chuẩn nằm ngoài màn hình hiển thị.

Đo độ dốc/Ống bọt nước kỹ thuật số

Hãy chọn đo độ nghiêng/ống bọt nước kỹ thuật số .

Dụng cụ đo tự động chuyển mạch giữa hai trạng thái.

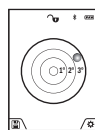

Ống bọt nước kỹ thuật số được sử dụng để kiểm tra các hướng nằm ngang hoặc thẳng đứng của một đối tượng (ví dụ như máy giặt, tủ lạnh, vv).

Khi độ nghiêng 3° bị vượt quá, hình cầu trong màn hình hiển thị chiếu sáng màu đỏ.

Cạnh dưới của dụng cụ đo được dùng làm mặt phẳng tham chiếu cho ống bọt nước kỹ thuật số.

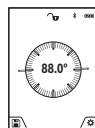

Đo độ nghiêng được sử dụng để đo độ dốc hoặc độ nghiêng (ví dụ như cầu thang, tay vịn cầu thang, khi khớp các đồ gỗ, khi lắp đặt ống, vv).

Cạnh trái của dụng cụ đo được dùng làm mặt phẳng tham chiếu để đo độ nghiêng. Khi chỉ thị báo sáng lên trong quá trình đo là do dụng cụ đo bị kéo nghiêng quá nhiều ở chiều bên kia.

Chức Năng Bộ Nhớ

Giá trị hoặc kết quả cuối cùng của mỗi lần đo xong sẽ được lưu trữ tự động.

Hiển thị giá trị bộ nhớ

Có thể thu được 50 giá trị tối đa (Các giá trị đo hoặc ảnh có các giá trị đo).

Bằng nút bấm mềm (12) hãy chọn chức năng bộ nhớ

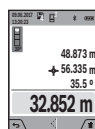

Số giá trị đã lưu được hiển thị ở phía trên của màn hình, bên dưới là giá đã lưu lệ thuộc và chức năng đo lệ thuộc. Nhấn nút (4) [+], để lật về trước thông qua các giá trị đã lưu.

Nhấn nút (11) [-], để lật trở lại thông qua các giá trị đã lưu.

Nếu không có giá trị nào trong bộ nhớ được hiển thị ở phía dưới của màn hình hiển thị „0.000“ và phía trên „0“.

Giá trị cũ nhất ở vị trí 1 trong bộ nhớ, giá trị mới nhất ở vị trí 50 (ở 50 giá trị đã lưu khả dụng). Khi lưu một giá trị tiếp theo, giá trị cũ nhất trong bộ nhớ sẽ bị xóa.

Xóa lưu trong Bộ Nhớ

Để mở bộ nhớ hãy nhấn nút bấm mềm (12) [■]. Để xóa giá trị do theo trình tự ngược lại hãy nhấn liên tục như mong muốn vào nút bấm mềm (3) [■]. Để xóa toàn bộ nội dung bộ nhớ hãy nhấn nút bấm mềm (3) [■] và nút thu phóng (5).

Cộng/trừ các giá trị

Các giá trị đo hoặc kết quả cuối cùng có thể được cộng vào hoặc bị trừ.

Cộng các giá trị

Ví dụ sau đây mô tả cộng diện tích: Hãy xác định diện tích theo đoạn „Đo Diện Tích“ (xem „Đo Diện Tích“, Trang 66).



Nhấn nút (4) [+]. Diện tích đã tính và biểu tượng „+“ được hiển thị. Nhấn nút đo (2) [▲], để khởi động phép đo diện tích tiếp theo. Xác định diện tích theo phần „Đo diện tích“ (xem „Đo Diện Tích“, Trang 66). Ngay khi phép đo thứ hai hoàn thành, kết quả của phép đo diện tích thứ hai sẽ được hiển thị ở bên dưới màn hình. Để hiển thị kết quả cuối cùng, hãy nhấn lại nút đo (2) [▲].

Hướng dẫn: Nếu là phép đo chiều dài, kết quả cuối cùng sẽ được hiển thị ngay lập tức.

Trừ các giá trị

Để trừ các giá trị hãy nhấn nút (11) [-]. Quy trình tiếp theo tương tự như „Cộng các giá trị“.

Xóa Trị Số Đo

Bằng việc nhấn nhanh nút Xóa Bật-tắt (9) [⏻] kết quả đo đơn mới nhất sẽ được xóa, áp dụng cho tất cả các chức năng đo.

Giao diện Bluetooth®

Truyền dữ liệu sang các thiết bị khác

Máy đo được trang bị một mô-đun Bluetooth® nhờ kỹ thuật sóng vô tuyến cho phép truyền dữ liệu tới các thiết bị di động đầu cuối với giao diện Bluetooth® (ví dụ điện thoại thông minh, máy tính bảng).

Các thông tin về điều kiện hệ thống cần thiết cho việc kết nối Bluetooth® có thể tìm thấy trên trang Web của Bosch theo địa chỉ www.bosch-pt.com.

► Thông tin tiếp theo xin vui lòng tìm trên trang sản phẩm Bosch.

Khi truyền dữ liệu thông qua Bluetooth® có thể sẽ xuất hiện thời gian ngừng (time delay) giữa thiết bị di động đầu cuối và máy đo. Điều này có thể là do

khoảng cách giữa hai thiết bị với nhau hoặc do chính đối tượng đo.

Kích hoạt giao diện Bluetooth® để truyền dữ liệu tới một thiết bị di động đầu cuối

Kích hoạt giao diện Bluetooth® được thực hiện trong các cài đặt. Để kích hoạt các tín hiệu Bluetooth® hãy nhấn nút (4) [+]. Hãy chắc chắn rằng, giao diện Bluetooth® trên thiết bị di động đầu cuối của bạn đã được kích hoạt.

Các ứng dụng đặc biệt (Apps) „Measuring Master“ của Bosch luôn có sẵn để trợ giúp việc mở rộng phạm vi chức năng của thiết bị di động đầu cuối và đơn giản hóa việc xử lý dữ liệu. Bạn có thể tải nó tùy theo thiết bị đầu cuối trong kho tương ứng.

Sau khi khởi động ứng dụng Bosch, hãy thiết lập kết nối giữa thiết bị đầu cuối và máy đo. Nếu phát hiện nhiều dụng cụ đo đã kích hoạt, hãy chọn dụng cụ đo phù hợp dựa theo số seri. Số seri (15) bạn hãy tìm trên nhãn thông tin nhận dạng dụng cụ đo. Trạng thái kết nối cũng như kết nối đang hoạt động (f) sẽ được hiển thị trong màn hình hiển thị (1) của dụng cụ đo.

Bỏ kích hoạt giao diện Bluetooth®

Bỏ kích hoạt kết nối Bluetooth® được thực hiện trong các cài đặt. Để bỏ kích hoạt tín hiệu Bluetooth® hãy nhấn nút (11) [-] hoặc tắt dụng cụ đo.

Hướng Dẫn Sử Dụng

- Thông tin tiếp theo xin vui lòng tìm trên trang sản phẩm Bosch.
- Máy đo được trang bị một giao diện sóng vô tuyến. Hãy chú ý các giới hạn địa điểm hoạt động ví dụ như trên máy bay hoặc bệnh viện.

Thông Tin Tổng Quát

Ống kính thu nhận (18), đầu ra của tia laser (19) và camera (20) không được bị che khi đo.

Không được di chuyển dụng cụ đo trong quá trình đo. Vì vậy, bạn phải đặt dụng cụ đo lên một bề mặt chuẩn hoặc mặt đố.

Những Tác Động Ảnh Hưởng Đến Khoảng Đo

Phạm vi đo hiệu quả phụ thuộc vào tình trạng ánh sáng và đặc tính phản xạ ánh sáng của bề mặt đối tượng. Hãy sử dụng camera được tích hợp (20), kính nhìn tia laser (26) (Phụ kiện) và bảng đích laser (25) (Phụ kiện) để cải thiện độ rõ của tia laser với ánh sáng từ bên ngoài, hoặc làm cho bề mặt đối tượng không hoạt động.

Những Tác Động Ảnh Hưởng Đến Kết Quả Đo

Do tác động vật lý, không thể tránh khỏi sự đo đạc bị sai khi đo những bề mặt khác nhau. Bao gồm các nguyên nhân sau đây:

- bề mặt trong suốt (ví dụ kính, nước),
- bề mặt phản chiếu (ví dụ thép mài nhẵn, kính),
- bề mặt rỗ (ví dụ kính, vật liệu cách nhiệt)
- bề mặt có kết cấu (ví dụ vữa nhám, đá tự nhiên).

Hãy sử dụng bảng đối tượng của tia laser (25) (phụ kiện) trên các bề mặt này nếu cần.

Thêm vào đó, sự đo sai cũng có thể xảy ra khi nhắm bề mặt một mục tiêu dốc nghiêng.

Cũng vậy, các tầng không khí có nhiệt độ thay đổi hay tiếp nhận sự phản chiếu gián tiếp có thể tác động đến trị số đo.

Kiểm tra độ chính xác và hiệu chỉnh độ dốc (xem hình H)

Thường xuyên kiểm tra độ chính xác của đo độ dốc. Việc này được thực hiện bằng phép đo đường bao. Hãy đặt dụng cụ đo lên bàn và đo độ dốc. Hãy xoay dụng cụ đo 180° và đo lại độ dốc. Độ sai khác của giá trị được hiển thị tối đa là 0,3°.

Đối với độ sai lệch lớn hơn bạn phải hiệu chuẩn lại dụng cụ đo. Lựa chọn  trong các cài đặt thiết bị. Làm theo các hướng dẫn trên màn hình hiển thị.

Sau những thay đổi mạnh về nhiệt độ và sau những sự va chạm, cần phải kiểm độ chính xác và nếu có thể hãy hiệu chỉnh máy. Sau khi có sự thay đổi về nhiệt độ máy đo phải được giảm nhiệt/làm mát trong thời gian nhất định trước khi hiệu chỉnh.

Kiểm tra độ chính xác của việc đo khoảng cách

Sự chính xác của dụng cụ đo có thể được kiểm tra như sau:

- Chọn một khu vực cố định, không thay đổi để đo, có chiều dài khoảng từ 3 đến 10 m; chiều dài của khu vực này phải được biết rõ chính xác (vd. chiều rộng của một căn phòng hay một khung cửa). Phép đo phải được thực hiện trong điều kiện thuận lợi, tức là khoảng cách đo phải ở trong phòng với ánh sáng nền yếu và bề mặt đối tượng của phép đo phải trơn nhẵn đồng thời có độ phản xạ tốt (ví dụ một bức tường sơn trắng).
- Đo khoảng cách 10 lần liên tiếp.

Sai lệch của các phép đo riêng biệt so với giá trị trung bình được vượt quá ± 2 mm tổng khoảng cách đo trong điều kiện thuận lợi. Ghi lại các phép đo để sau này có thể so sánh độ chính xác của các phép đo.

Kiểm tra độ chính xác và hiệu chỉnh hiển thị đích (Đường chữ thập)

Thường xuyên kiểm tra độ chính xác của hướng laser và hiển thị đích.

- Hãy chọn bề mặt sáng, được chiếu sáng yếu (ví dụ bức tường sơn trắng) ở khoảng cách tối thiểu 5 m để làm đích.
- Hãy kiểm tra xem điểm laser có nằm trong hiển thị đích trên màn hiển thị không.

Nếu điểm laser không nằm trong hiển thị đích, bạn phải hiệu chỉnh lại hiển thị đích.

Lựa chọn  trong các cài đặt thiết bị. Làm theo các hướng dẫn trên màn hình hiển thị.

Ở khoảng cách dài hơn (hơn năm mét), một đánh dấu cũng được hiện để đánh dấu điểm đo.

Sử dụng giá đỡ ba chân (phụ kiện)

Sử dụng giá ba chân là đặc biệt cần thiết cho khoảng cách lớn. Hãy đặt máy đo có ren 1/4" (17) lên đĩa nhả hãm nhanh của giá ba chân (27) hoặc một chiếc giá ba chân của máy ảnh thông thường. Bắt chặt dụng cụ đo bằng vít khóa của mâm đỡ thay nhanh.

Hãy cài đặt mặt phẳng tham chiếu cho các phép đo bằng giá đỡ ba chân trong các cài đặt (Mặt phẳng tham chiếu giá đỡ ba chân).

Lỗi – Nguyên nhân và biện pháp khắc phục

Nguyên nhân	Biện Pháp Sửa Chữa
Cảnh báo nhiệt độ nhấp nháy, không thể thực hiện đo	
Dụng cụ đo ở ngoài nhiệt độ làm việc từ -10 °C đến +45 °C (trong chức năng đo liên tục là tới +40 °C).	Đợi cho đến khi dụng cụ đo về lại nhiệt độ hoạt động cho phép.
Hiện ra chữ „ERROR“ trên màn hình	
Cộng/Trừ trị số đo bằng một đơn vị đo lường khác nhau	Chỉ cộng/ trừ trị số đo bằng cùng một đơn vị đo lường như nhau
Góc nằm giữa luồng laze và mục tiêu quá nhọn.	Mở rộng góc nằm giữa luồng laze và mục tiêu.
Bề mặt đối tượng phản xạ quá mạnh (ví dụ gương), hoặc ánh sáng xung quanh quá mạnh.	Sử dụng bảng đối tượng của tia laser (25) (Phụ kiện)
Đầu ra tia laser (19), ống kính thu nhận (18) hoặc camera (20) bị phủ sương (ví dụ do thay đổi nhiệt độ nhanh chóng).	Với khăn mềm hãy lau khô đầu ra tia laser (19), ống kính thu nhận (18) hoặc camera (20)

Nguyên nhân	Biện Pháp Sửa Chữa
-------------	--------------------

Kết quả đo được tính sẽ lớn hơn 1 999 999 hoặc nhỏ hơn -999 999 m/m ² /m ³ .	Chia sự tính toán thành các bước trung gian.
--	--

Hiển thị „CAL“ và hiển thị „ERROR“ trong màn hình	
---	--

Sự hiệu chuẩn của phép đo độ dốc không được thực hiện đúng theo trình tự hay đúng vào các vị trí.	Lập lại sự hiệu chuẩn dựa trên các hướng dẫn trên màn hình thị và trong các hướng dẫn hoạt động.
---	--

Bề mặt sử dụng để hiệu chuẩn không thật sự đồng vị chính xác (đường ngang và thẳng đứng).	Lập lại sự hiệu chuẩn trên bề mặt ngang hay thẳng đứng; nếu cần, kiểm tra bề mặt trước bằng cân thủy.
---	---

Dụng cụ đo bị chuyển dịch hay nghiêng xuống trong khi nhấn nút.	Lập lại sự hiệu chuẩn và giữ dụng cụ đo ở nguyên vị trí trong khi nhấn nút.
---	---

Kết quả đo không hợp lý	
-------------------------	--

Bề mặt đối tượng không phản chiếu rõ ràng (ví dụ nước, kính).	Bề mặt mục tiêu bị che phủ.
---	-----------------------------

Đầu ra tia laser (19) hoặc ống kính thu nhận (18) hoặc camera (20) bị che.	Giữ thoáng đầu ra tia laser (19), ống kính thu nhận (18) hoặc camera (20).
--	--

Chính đặt sai điểm xuất phát chuẩn.	Chọn điểm xuất phát chuẩn tương ứng với cách đo đạt.
-------------------------------------	--

Chướng ngại vật trên đường đi của luồng laze.	Điểm chiếu laze phải đến mục tiêu được thông suốt.
---	--

Bluetooth® không thể kích hoạt	
--------------------------------	--

Pin quá yếu.	Thay pin
--------------	----------

Không có kết nối Bluetooth®	
-----------------------------	--

Nhiều kết nối Bluetooth®	Hãy tắt Bluetooth® trên dụng cụ đo và trên thiết bị đầu cuối di động và bật lại.
--------------------------	--

	Kiểm tra ứng dụng trên thiết bị di động đầu cuối đang được dùng.
--	--

	Kiểm tra xem, liệu Bluetooth® giữa máy đo và thiết bị di động đầu cuối có được kích hoạt hay không.
--	---

	Kiểm tra mức quá tải của thiết bị di động đầu cuối đó.
--	--

	Rút ngắn khoảng cách giữa máy đo và thiết bị
--	--

Nguyên nhân	Biện Pháp Sửa Chữa
-------------	--------------------

	di động đầu cuối đang dùng.
--	-----------------------------

	Tránh các vật cản (ví dụ, bê tông cốt thép, cửa kim loại) giữa máy đo và thiết bị đầu cuối đang dùng. Giữ khoảng cách với nguồn gây nhiễu điện từ (ví dụ trạm phát Wifi).
--	---



Dụng cụ đo kiểm soát độ chính xác của mỗi phép đo. Nếu lỗi được phát hiện, màn hình chỉ hiển thị biểu tượng ở bên cạnh. Trong trường hợp này, hoặc nếu các biện pháp khắc phục nêu trên không thể loại bỏ lỗi, xin hãy chuyển dụng cụ đo đến bộ phận dịch vụ khách hàng của Bosch thông qua đại lý bán hàng của bạn.

Bảo Dưỡng và Bảo Quản

Bảo Dưỡng Và Làm Sạch

Luôn luôn giữ cho dụng cụ đo thật sạch sẽ.

Không được nhúng dụng cụ đo vào trong nước hay các chất lỏng khác.

Lau sạch bụi bẩn bằng một mảnh vải mềm và ẩm. Không được sử dụng chất tẩy rửa.

Làm sạch ống kính thu nhận (18), các đầu ra tia laser (19) và camera (20) thật cẩn thận: Đảm bảo rằng không có bụi bẩn trên ống kính thu nhận, đầu ra tia laser và camera. Chỉ làm sạch ống kính thu, đầu ra tia laser và camera bằng các chất thích hợp cho ống kính máy ảnh. Không thử dùng vật nhọn để lấy chất bẩn khỏi ống kính thu, đầu ra tia laser hoặc camera, và không lau qua đó (nguy cơ gây xước).

Trong trường hợp cần sửa chữa, hãy gửi dụng cụ đo trong túi bảo vệ (23).

Dịch vụ hỗ trợ khách hàng và tư vấn sử dụng

Bộ phận phục vụ hàng sau khi bán của chúng tôi trả lời các câu hỏi liên quan đến việc bảo dưỡng và sửa chữa các sản phẩm cũng như phụ tùng thay thế của bạn. Sơ đồ mô tả và thông tin về phụ tùng thay thế cũng có thể tra cứu theo dưới đây:

www.bosch-pt.com

Đội ngũ tư vấn sử dụng của Bosch sẽ giúp bạn giải đáp các thắc mắc về sản phẩm và phụ kiện.

Trong tất cả các phản hồi và đơn đặt phụ tùng, xin vui lòng luôn luôn nhập số hàng hóa 10 chữ số theo nhãn của hàng hóa.

Việt Nam

CN CÔNG TY TNHH BOSCH VIỆT NAM TẠI TP.HCM

Tầng 14, Ngôi Nhà Đức, 33 Lê Duẩn
Phường Bến Nghé, Quận 1, Thành Phố Hồ Chí Minh
Tel.: (028) 6258 3690
Fax: (028) 6258 3692 - 6258 3694
Hotline: (028) 6250 8555
Email: tuvankhachhang-pt@vn.bosch.com
www.bosch-pt.com.vn
www.baohanhbosch-pt.com.vn

Campuchia

Công ty TNHH Robert Bosch (Campuchia)
Đơn nguyên 8BC, GT Tower, Tầng 08, Đường 169,
Tiệp Khắc Blvd, Sangkat Veal Vong,
Khan 7 Makara, Phnom Penh
VAT TIN: 100 169 511
Tel.: +855 23 900 685
Tel.: +855 23 900 660
www.bosch.com.kh

Sự thải bỏ

Dụng cụ đo, phụ kiện và bao bì phải được phân loại để tái chế theo hướng thân thiện với môi trường.



Không vứt dụng cụ đo và pin cùng trong rác thải của gia đình!

Licenses

Copyright © 2016–2019 STMicroelectronics

All rights reserved.

Redistribution and use in source and binary forms, with or without modification, are permitted provided that the following conditions are met:

- Redistributions of source code must retain the above copyright notice, this list of conditions and the following disclaimer.
- Redistributions in binary form must reproduce the above copyright notice, this list of conditions and the following disclaimer in the documentation and/or other materials provided with the distribution.
- Neither the name of STMicroelectronics nor the names of its contributors may be used to endorse or promote products derived from this software without specific prior written permission.

THIS SOFTWARE IS PROVIDED BY THE COPYRIGHT HOLDERS AND CONTRIBUTORS "AS IS" AND ANY EXPRESS OR IMPLIED WARRANTIES, INCLUDING, BUT NOT LIMITED TO, THE IMPLIED WARRANTIES OF MERCHANTABILITY AND FITNESS FOR A PARTICULAR PURPOSE ARE DISCLAIMED. IN NO EVENT SHALL THE COPYRIGHT OWNER OR CONTRIBUTORS BE LIABLE FOR ANY DIRECT, INDIRECT, INCIDENTAL, SPECIAL, EXEMPLARY, OR CONSEQUENTIAL DAMAGES (INCLUDING, BUT NOT LIMITED TO, PROCUREMENT OF SUBSTITUTE GOODS OR SERVICES; LOSS OF USE, DATA, OR PROFITS; OR BUSINESS INTERRUPTION) HOWEVER CAUSED AND ON ANY THEORY OF LIABILITY, WHETHER IN CONTRACT, STRICT LIABILITY, OR TORT (INCLUDING NEGLIGENCE OR OTHERWISE) ARISING IN ANY WAY OUT OF THE USE OF THIS SOFTWARE, EVEN IF ADVISED OF THE POSSIBILITY OF SUCH DAMAGE.

Copyright © 2009–2016 ARM LIMITED

All rights reserved.

Redistribution and use in source and binary forms, with or without modification, are permitted provided that the following conditions are met:

- Redistributions of source code must retain the above copyright notice, this list of conditions and the following disclaimer.
- Redistributions in binary form must reproduce the above copyright notice, this list of conditions and the following disclaimer in the documentation and/or other materials provided with the distribution.
- Neither the name of ARM nor the names of its contributors may be used to endorse or promote products derived from this software without specific prior written permission.

THIS SOFTWARE IS PROVIDED BY THE COPYRIGHT HOLDERS AND CONTRIBUTORS "AS IS" AND ANY EXPRESS OR IMPLIED WARRANTIES, INCLUDING, BUT NOT LIMITED TO, THE IMPLIED WARRANTIES OF MERCHANTABILITY AND FITNESS FOR A PARTICULAR PURPOSE ARE DISCLAIMED. IN NO EVENT SHALL THE COPYRIGHT OWNER OR CONTRIBUTORS BE LIABLE FOR ANY DIRECT, INDIRECT, INCIDENTAL, SPECIAL, EXEMPLARY, OR CONSEQUENTIAL DAMAGES (INCLUDING, BUT NOT LIMITED TO, PROCUREMENT OF SUBSTITUTE GOODS OR SERVICES; LOSS OF USE, DATA, OR PROFITS; OR BUSINESS INTERRUPTION) HOWEVER CAUSED AND ON ANY THEORY OF LIABILITY, WHETHER IN CONTRACT, STRICT LIABILITY, OR TORT (INCLUDING NEGLIGENCE OR OTHERWISE) ARISING IN ANY WAY OUT OF THE USE OF THIS SOFTWARE, EVEN IF ADVISED OF THE POSSIBILITY OF SUCH DAMAGE.