

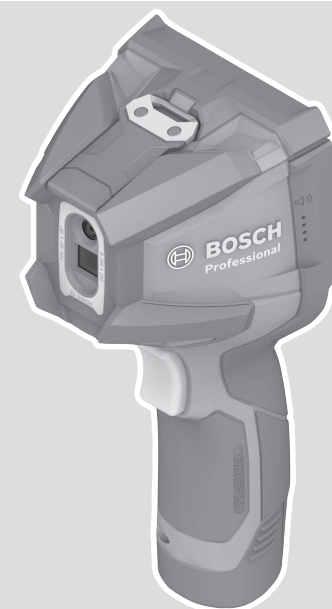

GTC 600 C Professional



Robert Bosch Power Tools GmbH
70538 Stuttgart
GERMANY

www.bosch-pt.com

1 609 92A 8BJ (2022.10) T / 76



1 609 92A 8BJ

- en Original instructions
- zh 正本使用说明书
- zh 原始使用說明書
- ko 사용 설명서 원본
- th หนังสือคู่มือการใช้งานฉบับต้นแบบ
- id Petunjuk-Petunjuk untuk Penggunaan Orisinal
- vi Bản gốc hướng dẫn sử dụng



English	Page	5
中文	页	15
繁體中文	頁	24
한국어	페이지	33
ไทย	หน้า	43
Bahasa Indonesia	Halaman	55
Tiếng Việt	Trang	65

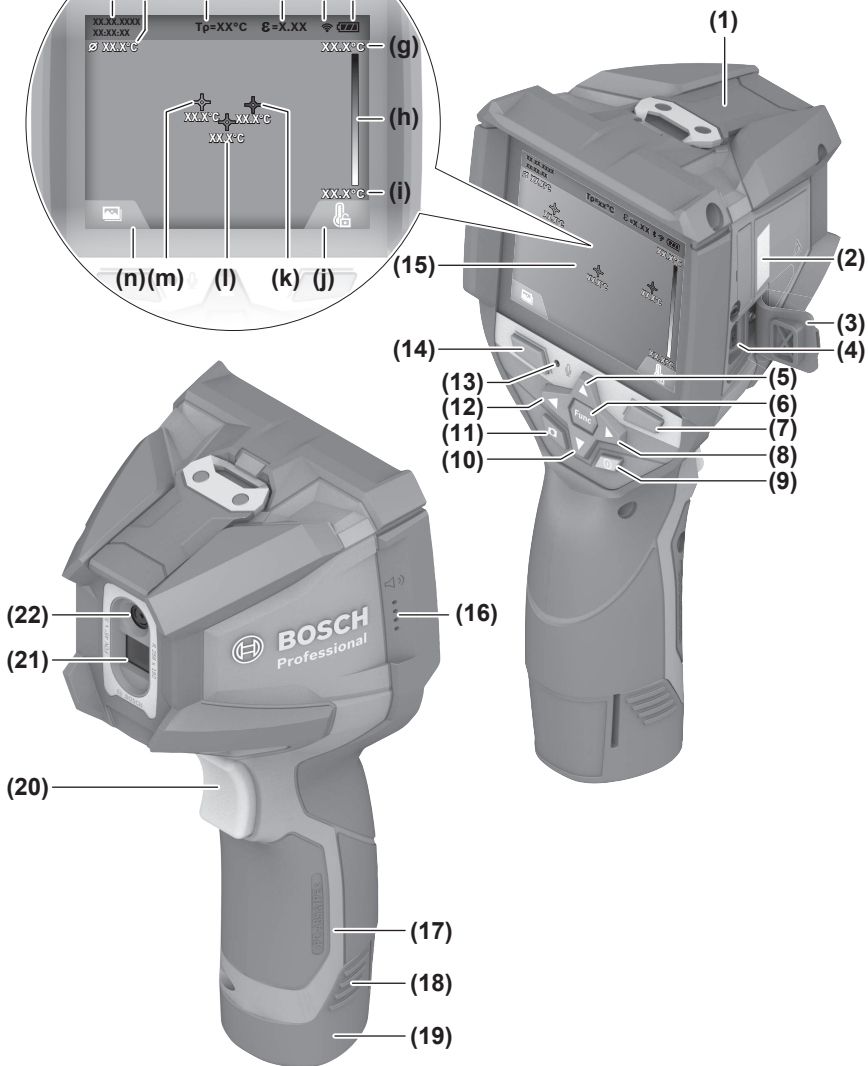
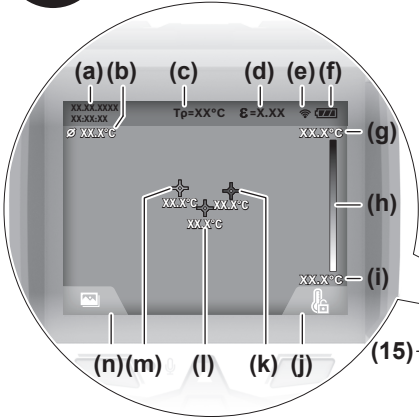

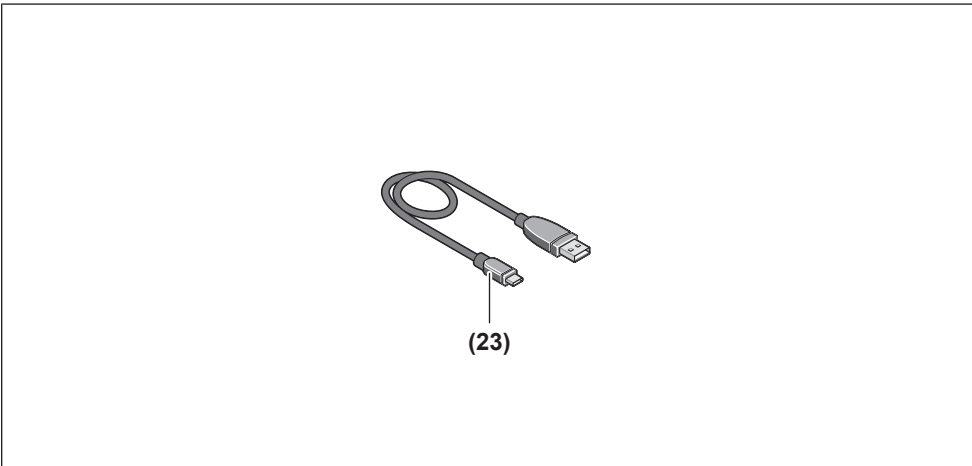
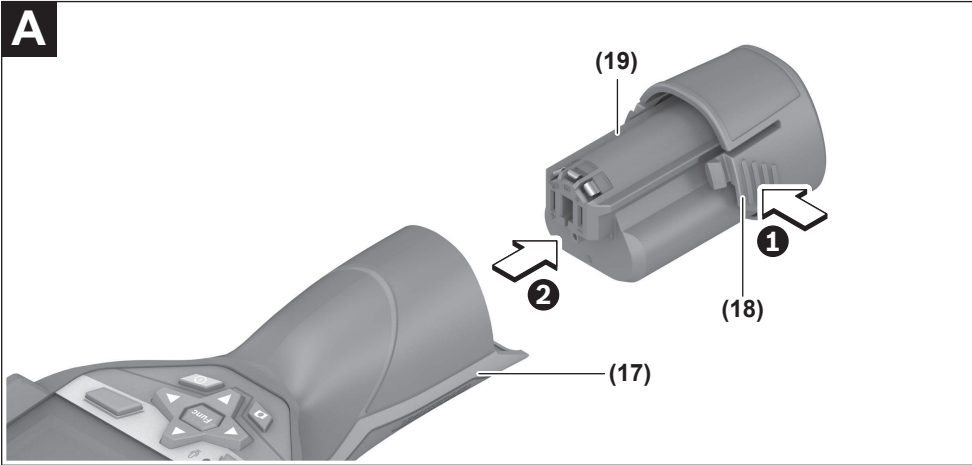

English

Safety Instructions



All instructions must be read and observed. The safeguards integrated into the measuring tool may be compromised if the measuring tool is not used in accordance with these

instructions. **STORE THESE INSTRUCTIONS IN A SAFE PLACE.**

- ▶ **Have the measuring tool serviced only by a qualified specialist using only original replacement parts.** This will ensure that the safety of the measuring tool is maintained.
- ▶ **Do not use the measuring tool in explosive atmospheres which contain flammable liquids, gases or dust.** Sparks may be produced inside the measuring tool, which can ignite dust or fumes.
- ▶ **Do not open the battery.** There is a risk of short-circuiting.
- ▶ **In case of damage and improper use of the battery, vapours may be emitted. The battery can set alight or explode.** Ensure the area is well ventilated and seek medical attention should you experience any adverse effects. The vapours may irritate the respiratory system.
- ▶ **If used incorrectly or if the battery is damaged, flammable liquid may be ejected from the battery. Contact with this liquid should be avoided. If contact accidentally occurs, rinse off with water. If the liquid comes into contact with your eyes, seek additional medical attention.** Liquid ejected from the battery may cause irritation or burns.
- ▶ **The battery can be damaged by pointed objects such as nails or screwdrivers or by force applied externally.** An internal short circuit may occur, causing the battery to burn, smoke, explode or overheat.
- ▶ **When the battery is not in use, keep it away from paper clips, coins, keys, nails, screws or other small metal objects that could make a connection from one terminal to another.** A short circuit between the battery terminals may cause burns or a fire.
- ▶ **Only use the battery with products from the manufacturer.** This is the only way in which you can protect the battery against dangerous overload.
- ▶ **Only charge the batteries using chargers recommended by the manufacturer.** A charger that is suitable for one type of battery may pose a fire risk when used with a different battery.



Protect the battery against heat, e.g. against continuous intense sunlight, fire, dirt, water and moisture. There is a risk of explosion and short-circuiting.



- ▶ **Protect the measuring tool, particularly the area around the infrared lens, speaker and microphone, from moisture, snow, dust and dirt. The reception lens**

could fog up or become contaminated and distort the measurements. Incorrect settings on the tool and other atmospheric influences may make the measurements inaccurate. Object temperatures could be shown to be hotter or colder than they are, which may present a danger if touched.

- ▶ **High temperature differences in a thermal image may cause even high temperatures to be shown in a colour associated with low temperatures.** Coming into contact with such an area may cause burns.
- ▶ **Temperature measurements will only be correct if the emissivity setting matches the emissivity of the object.** Otherwise, object temperatures could be shown to be hotter or colder than they are, which may present a danger if touched.
- ▶ **Do not point the measuring tool directly at the sun or at high-performance CO₂ lasers.** This may damage the detector.
- ▶ **Do not place the measuring tool on the rechargeable battery.** It can easily tip over. The fall may cause injuries.



Keep the magnet away from implants and other medical devices, e.g. pacemakers or insulin pumps. The magnet generates a field that can impair the function of implants and medical devices.

- ▶ **Keep the measuring tool away from magnetic storage media and magnetically-sensitive devices.** The effect of the magnets can lead to irreversible data loss.
- ▶ **The measuring tool is equipped with a wireless interface. Local operating restrictions, e.g. in aeroplanes or hospitals, must be observed.**



WARNING



Ensure that the coin cell is kept out of the reach of children. Coin cells are dangerous.

- ▶ **Coin cells must never be swallowed or inserted into any other part of the body. If you suspect that someone has swallowed a coin cell or that a coin cell has entered the body in another way, seek medical attention immediately.** Swallowing coin cells can result in severe internal burns and death within 2 hours.
- ▶ **Ensure that coin cell replacement is carried out properly.** There is a risk of explosion.
- ▶ **Only use the coin cells listed in this operating manual.** Do not use any other coin cells or other forms of electrical power supply.
- ▶ **Do not attempt to recharge the coin cell and do not short circuit the coin cell.** The coin cell may leak, explode, catch fire and cause personal injury.
- ▶ **Remove and dispose of drained coin cell correctly.** Drained coin cell may leak and damage the product or cause personal injury.

- ▶ **Do not overheat the coin cell or throw it into fire.** The coin cell may leak, explode, catch fire and cause personal injury.
- ▶ **Do not damage the coin cell and take the coin cell apart.** The coin cell may leak, explode, catch fire and cause personal injury.
- ▶ **Do not allow damaged coin cells to come into contact with water.** Leaking lithium may mix with water to create hydrogen, which could cause a fire, an explosion, or personal injury.
- ▶ If the coin cell holder cannot be closed correctly and fully, stop using the measuring tool, remove the coin cell and have the measuring tool repaired.

Product Description and Specifications

Please observe the illustrations at the beginning of this operating manual.

Intended Use

This thermal imaging camera is designed for the contactless measurement of surface temperatures.

The displayed thermal image shows the temperature distribution in the thermal imaging camera's field of view and therefore enables temperature deviations to be depicted in different colours.

When used correctly, this makes it possible to examine areas and objects in a contactless manner for temperature differences and discrepancies in order to make components and/or any weaknesses visible, including:

- Thermal insulation and other types of insulation (e.g. locating thermal bridges)
- Active heating and hot water pipes (e.g. underfloor heating) in floors and walls
- Overheated electrical components (e.g. fuses or terminals)
- Faulty or damaged machine parts (e.g. overheating due to faulty ball bearings)

The measuring tool is not suitable for measuring the temperature of gases.

The measuring tool may not be used to measure the body temperature of humans or animals or for other medical purposes.

The measuring tool is suitable for indoor and outdoor use.

Product Features

The numbering of the product features shown refers to the illustration of the measuring tool on the graphic page.

- (1) Protective cap for visual camera and infrared sensor
- (2) Serial number

- (3) Flap for USB port
- (4) USB Type-C® port^{a)}
- (5) Up arrow button
- (6) Measuring functions button **Func**
- (7) Switching temperature scale between automatic and fixed/right-hand function button
- (8) Right-hand arrow button
- (9) On/off button
- (10) Down arrow button
- (11) Save button
- (12) Left-hand arrow button
- (13) Microphone
- (14) Gallery button/left-hand function button
- (15) Display
- (16) Speaker
- (17) Battery bay
- (18) Battery release button^{b)}
- (19) Rechargeable battery^{b)}
- (20) Pause/start measurement button
- (21) Infrared sensor
- (22) Visual camera
- (23) USB Type-C® cable

a) USB Type-C® and USB-C® are trademarks of USB Implementers Forum.

b) **The accessories illustrated or described are not included as standard delivery.**

Display Elements

- (a) Time/date indicator
- (b) Average temperature indicator
- (c) Reflected temperature indicator
- (d) Emissivity indicator
- (e) Wi-Fi® switched on/off indicator^{a)}
- (f) Battery charge indicator
- (g) Maximum surface temperature in the measuring range indicator
- (h) Scale
- (i) Minimum surface temperature in the measuring range indicator
- (j) Fix temperature scale symbol
- (k) Hotspot indicator (example)
- (l) Crosshairs with temperature indicator
- (m) Cold spot indicator (example)
- (n) Gallery symbol

a) Wi-Fi® is a registered trademark of the Wi-Fi Alliance®.

Technical Data

Thermal imaging camera	GTC 600 C
Article number	3 601 K83 5..
Resolution of infrared sensor	256 × 192 px
Thermal sensitivity ^{A)}	≤ 50 mK
Spectral range	8–14 μm
Field of view (FOV) ^{B)}	45° × 35°
Focus distance ^{B)}	≥ 0.3 m
Focus	Fixed
Thermal image refresh rate	9 Hz
Surface temperature measuring range ^{B)}	-20 to +600 °C
Surface temperature measuring accuracy ^{B)(C)(D)}	
-20 to ≤ +10 °C	±4 °C
> 10 to ≤ 100 °C	±2 °C
> +100 °C	±2 %
Temperature resolution	0.1 °C
Max. altitude	2000 m
Pollution degree according to IEC 61010-1	2 ^{E)}
Max. relative humidity ^{B)}	90 %
Display type	TFT
Display size	3.5"
Display resolution	320 × 240
Image format	.jpg
Audio format	.wav
Elements saved per saving process	1 × thermal image (screenshot), 1 × real visual image incl. temperature values (metadata), 1 × voice note if applicable
Number of images in internal image memory	600
Number of images with a 10 s voice note each in internal image memory	350
Integrated visual camera resolution	640 × 480 px
Rechargeable battery (Li-ion)	10.8 V/12 V
Rechargeable battery operating time (Li-ion) ^{F)(G)}	6 h
USB port	2.0
System time power supply	CR 2032 (3 V lithium battery) ^{H)}
Wireless connectivity	WLAN
Max. WLAN transmission power	< 20 mW
WLAN operating frequency range	2402–2480 MHz
Weight according to EPTA-Procedure 01:2014	0.64–0.75 kg ^{F)}
Dimensions (length × width × height)	115 × 102 × 231 mm
Protection rating (excluding rechargeable batteries, in the vertical position)	IP54
Permitted environmental conditions	
– Recommended ambient temperature during charging	0 to +35 °C
– Operating temperature	-10 to +45 °C
– During storage with a rechargeable battery	-20 to +50 °C
– During storage without a rechargeable battery	-20 to +70 °C

Thermal imaging camera	GTC 600 C
Recommended rechargeable batteries	GBA 10,8 V GBA 12 V
Recommended chargers	GAL 12... GAX 18...

- A) In accordance with standard VDI 5585 (average)
 B) In accordance with standard VDI 5585
 C) At an ambient temperature of 20 to 23 °C and an emissivity of > 0.999, measuring distance: 0.3 m, operating time: > 5 min, aperture of 60 mm
 D) Plus use-dependent deviation (e.g. reflection, distance, ambient temperature)
 E) Only non-conductive deposits occur, whereby occasional temporary conductivity caused by condensation is expected.
 F) Depends on battery in use
 G) At an ambient temperature of **20–30 °C**
 H) The coin cell replacement must be performed by Bosch or by an after-sales service centre authorised to work with Bosch power tools.
 Technical data determined using the battery that comes with the product.

The serial number **(2)** on the type plate is used to clearly identify your measuring tool.

Assembly

Battery Charging (see figure A)

- **Use only the chargers listed in the technical data.** Only these chargers are matched to the lithium-ion battery of your measuring tool.

Note: The use of batteries unsuitable for your measuring tool can lead to malfunctions or damage to the measuring tool.

Note: The battery is supplied partially charged. To ensure full capacity of the battery, completely charge the battery before the first use.

The lithium-ion battery can be charged at any time without reducing its service life. Interrupting the charging process does not damage the battery.

To **insert** the charged battery pack **(19)**, slide it into the battery bay **(17)** until you feel it click into place and it is flush with the handle of the measuring tool.

To **remove** the battery pack **(19)**, press the release buttons **(18)** and pull the battery pack out of the battery bay **(17)**. **Do not use force to do this.**

Operation

- **Protect the measuring tool from moisture and direct sunlight.**
- **Do not expose the measuring tool to any extreme temperatures or variations in temperature.** For example, do not leave it in a car for extended periods of time. In case of large variations in temperature, allow the measuring tool to adjust to the ambient temperature before putting it into operation. The precision of the measuring tool may be compromised if exposed to extreme temperatures or variations in temperature.
- **Make sure that the measuring tool is correctly acclimatised.** In case of large variations in temperature, acclimatisation can take up to **60** minutes. This may be the case, for example, if you store the measuring tool in a cool car and then perform a measurement in a warm building.

- **Avoid hard knocks to the measuring tool or dropping it.** After severe external influences and in the event of abnormalities in the functionality, you should have the measuring tool checked by an authorised **Bosch** after-sales service agent.

Starting Operation

Switching On and Off

To take a measurement, fold the protective cap **(1)** upwards. **Make sure that the infrared sensor is not closed off or covered while working.**

To **switch on** the measuring tool, press the on/off button **(9)**. A start sequence will appear on the display **(15)**. The measuring tool begins to take measurements as soon as the start sequence has finished and does so continuously until it is switched off.

Note: In the first few minutes, the measuring tool may self-calibrate several times, as the sensor temperature and ambient temperature have not yet been brought into line. Performing sensor calibration again enables precise measurement.

During this time, the temperature indicator may show ~. The thermal image will freeze briefly during sensor calibration. If the ambient temperature fluctuates significantly, this effect is increased. If possible, you should therefore turn on the measuring tool a few minutes before starting to measure, so that the tool can stabilise thermally.

To **switch off** the measuring tool, press the on/off button **(9)** again. The measuring tool saves all settings and then switches itself off. Close the protective cap **(1)** to transport the measuring tool safely.

In the main menu, you can choose whether and after how long the measuring tool automatically switches off (see "Main Menu", page 11).

If the battery pack or the measuring tool is not within the operating temperature range specified in the technical data, the measuring tool will switch off automatically after a brief warning (see "Errors – Causes and Corrective Measures",

page 13). Allow the measuring tool to reach the correct temperature and then switch it back on.

Measurement Preparations

Setting the emissivity for surface temperature measurements

The emissivity of an object depends on the material and the structure of its surface. This specifies how much infrared thermal radiation the object emits compared with an ideal radiant warmer (black body, emissivity $\epsilon = 1$) and accordingly has a value between 0 and 1.

To determine the surface temperature, the tool performs a contactless measurement of the natural infrared thermal radiation emitted by the object at which the tool is aimed. To ensure correct measurement, the emissivity setting on the measuring tool must be checked **before every measurement** and adapted to the measuring object if necessary.

The preset emissivities in the measuring tool are reference values.

You can select one of the preset emissivities or enter an exact numerical value. Set the required emissivity via the **<Measurement>** → **<Emissivity>** menu (see "Main Menu", page 11).

► **Temperature measurements will only be correct if the emissivity setting and the emissivity of the object match.**

The lower the emissivity, the greater the effect of the reflected temperature on the measuring result. Always adjust the reflected temperature when changing the emissivity. Set the reflected temperature via the **<Measurement>** → **<Reflected Temp.>** menu (see "Main Menu", page 11).

Temperature differences allegedly shown by the measuring tool may be caused by different temperatures and/or different emissivity levels. If the emissivity levels are very different, the depicted temperature differences may differ considerably from the actual temperature differences.

If there are multiple objects made of different materials or that have different structures in the measuring range, the displayed temperature values are only accurate for the objects that match the emissivity setting. For all other objects (with different emissivity levels), the displayed colour differences can be used as an indication of temperature relationships.

Information about the Measuring Conditions

Highly reflective or shiny surfaces (e.g. shiny tiles or polished metals) may significantly distort or impair the results shown. If necessary, mask the measuring surface with a dark, matt adhesive tape that conducts heat well. Allow the tape to briefly reach the correct temperature on the surface. Make sure that a favourable measuring angle is used on reflective surfaces in order to ensure that the thermal radiation reflected by other objects does not distort the result. For example, the reflection of your own emitted body heat may interfere with the measurement when measuring head-on from a perpendicular position. On a level surface, the outline and temperature of your body could therefore be displayed (reflected value), and these values do not correspond to the ac-

tual temperature of the measured surface (emitted value or real value of the surface).

Measuring through transparent materials (e.g. glass or transparent plastics) is fundamentally not possible.

Consequently, the more suitable and stable the measuring conditions are, the more accurate and reliable the measurement readings are. Not only do significant fluctuations in the temperature of the environmental conditions have an impact, the accuracy can also be impaired by significant fluctuations in the temperatures of the object being measured. Infrared temperature measurement is impaired by smoke, steam/high humidity or dusty air.

Information for achieving improved measurement accuracy:

- Move as close as possible to the object to be measured to minimise interfering factors between you and the surface to be measured.
- Ventilate indoor areas prior to measurement, especially when the air is contaminated or extremely steamy. Once ventilated, allow the room to reacclimatise a while until it returns to the usual temperature.

Assigning Temperatures on the Basis of the Scale

A scale **(h)** is shown on the right-hand side of the display. The values at the top and bottom end are oriented to the maximum **(g)** and minimum **(i)** temperature recorded in the thermal image. For the scale, **99.9 %** of the total pixels are evaluated. Colours are assigned to temperature values with a uniform distribution in the image (linearly).

Different shades can therefore be used to assign temperatures within these two limit values. For example, a temperature that is exactly between the maximum and minimum value is assigned to the centre colour range of the scale.



To determine the temperature of a specific area, move the measuring tool so that the crosshairs with temperature display **(I)** are aimed at the required point or area. In the automatic setting, the colour spectrum of the scale is always distributed linearly (= uniformly) across the entire measuring range between the maximum and minimum temperatures.

The measuring tool displays all measured temperatures in the measuring range in relation to one another. If heat is displayed as blue in the colour palette in an area, for example in a colour representation, this means that the blue areas are among the colder measured values in the current measuring range. However, these areas may still be in a temperature range which could cause injuries in certain circumstances. You should therefore always note the temperatures displayed on the scale or at the crosshairs themselves.

Functions

Adjusting the Colour Display

Depending on the measurement conditions, different colour palettes may make it easier to analyse the thermal image and display objects or circumstances more clearly in the display. This does not affect the measured temperatures. The only change is the way in which the temperature values are displayed.

To change the colour palette, remain in measuring mode and press the right-hand **(8)** or left-hand **(12)** arrow button.

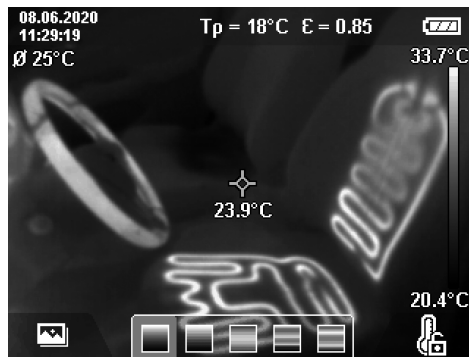

Superimposition of Thermal Image and Real Image

For improved orientation (= local assignment of the thermal image displayed), with matched temperature ranges, a real visual image can additionally be inserted.

Note: The superimposition of the real image and thermal image corresponds exactly at a distance of 0.55 m. If the tool is closer to or further away from the object being measured, this fundamentally results in misalignment of the real image and thermal image. This misalignment can be compensated for with the GTC Transfer Software.

The measuring tool camera offers you the following options:

- **Complete infrared image**
Only the thermal image is displayed.
- **Picture-in-picture**
The thermal image displayed is cropped and the surrounding area is shown as a real image. This setting improves the local assignment of the measuring range.
- **Transparency**
The thermal image displayed is placed on top of the real image in such a way that it is transparent. This enables improved detection of objects.

You can select the setting by pressing the up **(5)** or down **(10)** arrow buttons.



Fixing the Scale

The colour distribution in the thermal image is adjusted automatically but can be fixed by pressing the right-hand function button **(7)**. This enables a comparison to be made between thermal images taken under different temperature conditions (e.g. when checking several rooms for thermal bridges). It also allows an extremely cold or hot object to be hidden in the thermal image. This object would otherwise distort the image (e.g. a radiator as a hot object when searching for thermal bridges).

To switch the scale back to automatic, press the right-hand function button **(7)** again. The temperatures are now dynamic again and adapt to the measured minimum and maximum values.

Measuring Functions

To call up further functions that may be helpful for the display, press the **Func (6)** button. Use the left-hand arrow button **(12)** or the right-hand arrow button **(8)** to navigate through the displayed options to select a function. Select a function and press the **Func (6)** button again.

The following measuring functions are available:

- **<Automatic>**
Colours are distributed automatically in the thermal image.
- **<Heat Detector>**
Only the warmer temperatures in the measuring range are displayed as a thermal image in this measuring function. The area outside these warmer temperatures is shown as a real image in grey scale. The depiction in grey scale prevents coloured objects from being wrongly associated with temperatures (e.g. a red cable in the control cabinet when searching for overheated components). Adjust the scale using the up arrow button **(5)** and down arrow button **(10)**. This expands or reduces the temperature range, thereby expanding or reducing the thermal image. The measuring tool continues to measure minimum and maximum temperatures and displays these at the ends of the scale **(h)**.
- **<Cold Detector>**
Only the colder temperatures in the measuring range are displayed as a thermal image in this measuring function.

The area outside these colder temperatures is shown as a real image in grey scale to prevent coloured objects from being wrongly associated with temperatures (e.g. a blue window frame when searching for faulty insulation). Adjust the scale using the up arrow button (5) and down arrow button (10). This expands or reduces the temperature range, thereby expanding or reducing the thermal image. The measuring tool continues to measure minimum and maximum temperatures and displays these at the ends of the scale (h).

– <Manual>

If greatly deviating temperatures are measured in the thermal image (e.g. a radiator as a hot object when searching for thermal bridges), the available colours are distributed among a large number of temperature values in the range between the maximum and the minimum temperature. This can result in a situation where subtle temperature differences can no longer be shown in detail. To obtain a detailed depiction of the temperature range to be examined, take the following steps: After switching to <Manual> mode, you can set the maximum and the minimum temperature. Doing this enables you to set the temperature range that is relevant to you and in which you would like to detect subtle differences. The <Reset scale> setting automatically readjusts the scale to the measured values in the infrared sensor's field of view.

Main Menu

To access the main menu, first press the **Func (6)** button to call up the measuring functions. Now press the right-hand function button (7).

– <Measurement>

▪ <Emissivity> (d)

A selection of saved emissivities is available for some of the most common materials. Choose the relevant material in the <Material> menu item. The corresponding emissivity is shown in the line beneath. If you know the exact emissivity of the object you want to measure, you can also set it as a numerical value in the <Emissivity> menu item.

If you frequently measure the same materials, you can enter five emissivities as favourites and quickly call them up via the bar at the top (numbered from 1 to 5).

▪ <Reflected Temp.> (c)

Setting this parameter can improve the accuracy of the measuring result, especially with low-emissivity (= high-reflection) materials. In some situations (especially in indoor areas) the reflected temperature corresponds to the ambient temperature. If there are objects with greatly deviating temperatures close to highly reflective objects, this value should be adjusted as the measurement may be affected.

– <Display>

▪ <Centerspot> (l)

The point is displayed in the centre of the thermal image and shows you the measured temperature value at this point.

▪ <Hotspot> (k): <ON>/<OFF>

The hottest point (= measuring pixel) is indicated by red crosshairs in the thermal image. This facilitates the search for critical areas (e.g. a loose contact terminal in the control cabinet). To make the measurement as accurate as possible, focus the object to be measured in the centre of the display (85 × 64 px). This way, the corresponding temperature value of this object will be shown as well.

▪ <Coldspot> (m): <ON>/<OFF>

The coldest point (= measuring pixel) is indicated by blue crosshairs in the thermal image. This facilitates the search for critical areas (e.g. a leak in a window). To make the measurement as accurate as possible, focus the object to be measured in the centre of the display (85 × 64 px).

▪ <Color Scale> (h): <ON>/<OFF>

▪ <Average Temp.> (b): <ON> / <OFF>

The average temperature (b) is displayed at the top left of the thermal image (average temperature of all measured values in the thermal image). This can help you to determine the reflected temperature.

– <WiFi> (e): <ON>/<OFF>

(see "Data Transfer", page 12)

– <Tool>

▪ <Language>

Under this menu item, you can select the language used in the display.

▪ <Time & Date> (a)

To change the time and date shown in the measuring tool, call up the <Time & Date> submenu. This submenu not only allows you to set the time and date but also to change their respective formats. To exit the <Time> and <Date> submenu, press either the right-hand function button (7) to save the settings, or the left-hand function button (14) to discard the changes.

▪ <Shutdown Time>

Under this menu item, you can select the time interval after which the measuring tool will automatically switch off if no buttons are pressed. You can also deactivate automatic switch-off by selecting the <Never> setting.

▪ <WiFi Channel>

Under this menu item, you can set another Wi-Fi® channel.

▪ <High audio quality>

Under this menu item, you can adjust the quality of the recorded audio file via voice memo. Please note that more storage space is required for a high audio quality.

▪ <Tool Information>

Under this menu item, you can access information about the measuring tool. There you will find the serial number of the measuring tool and the installed software version.

▪ <Factory settings>

Under this menu item, you can reset the measuring tool to factory settings and permanently delete all data. This may take several minutes. Press the right-

hand arrow button **(8)** for **<More>** to enter this submenu. Then press either the right function button **(7)** to delete all files or the left function button **(14)** to cancel the process.

You can also press the measuring button **(20)** to exit any menu and return to the home screen.

Documenting Measurements

Saving Measurements

The measuring tool begins to take measurements as soon as it is switched on and does so continuously until it is switched off.

To save an image, point the camera at the required measuring object and press the "Save" button **(11)**. The image is saved in the internal memory of the measuring tool. Alternatively, press the measuring button **(20)** (pause). The measurement is frozen and shown in the display. This enables you to carefully view the image and to make retrospective adjustments (e.g. to the colour palette). If you do not wish to save the frozen image, restart measuring mode by pressing the measuring button **(20)**. If you wish to save the image in the internal memory of the measuring tool, press the "Save" button **(11)**.

Recording a Voice Note

You can record a voice note to keep a record of environmental conditions or additional information about the saved thermal image. This information is saved in addition to the thermal image and visual image and can be transferred at a later stage.

It is recommended that you record a voice note in order to keep better documentation.

The voice note is recorded in the gallery. Proceed as follows:

- To access the gallery, press the left-hand function button **(14)**.
- Press the **Func (6)** button. The recording will start. Record all the relevant information.
- To **end** the recording, either press the **Func (6)** button again or press the right-hand function button **(7)**.
- To **cancel** the recording, press the left-hand function button **(14)**. After you have made the recording, you will be able to listen to the voice note.
- To **listen back** to the recording, press the **Func (6)** button again. The recording will be played back.
 - To **pause** playback, press the right-hand function button **(7)**. To continue playing the paused recording, press the right-hand function button **(7)** again.
 - To **stop** playback, press the left-hand function button **(14)**.

To record a new voice note, delete the current voice note and then start a new recording.

When recording, please note the following:

- The microphone **(13)** is located behind the keyboard next to the microphone symbol. Speak in the direction of the microphone.
- The recording can last a maximum of 30 seconds.

Calling Up Saved Images

Proceed as follows to call up saved thermal images:

- Press the left-hand function button **(14)**. The most recently saved photo now appears in the display.
- Press the right-hand **(8)** or left-hand **(12)** arrow button to switch between the saved thermal images.

The visual image has been saved alongside the thermal image. To call up the visual image, press the down arrow button **(10)**.

You can also display the thermal image taken as a full-screen image by pressing on the up arrow button **(5)**. In the full-screen view, the title bar is hidden after 3 seconds so that you can see all the details of the thermal image.

You can use the up arrow button **(5)** and the down arrow button **(10)** to switch between views.

Deleting Saved Images and Voice Notes

Switch to the gallery view to delete individual or all thermal images:

- Press the right-hand function button **(7)** under the waste paper basket symbol. A submenu will open. Here you can select whether you want to delete only this image, only the corresponding voice note (if you have recorded one) or all images. If you want to delete only this image or the voice note, confirm the process by pressing the **Func (6)** button.
- If you want you delete all images, press the **Func (6)** button or the right-hand function button **(7)**; you can also confirm the process by pressing the right-hand function button **(7)** or cancel the deletion by pressing the left-hand function button **(14)**.

Data fragments of the images remain stored in the memory and could be reconstructed. You can select **<Tool>** → **<Factory settings>** in the main menu to permanently delete.

Data Transfer

Data Transfer via USB Port

Open the flap for the USB Type-C® port **(3)**. Connect the USB Type-C® port **(4)** of the measuring tool to your computer via the USB Type-C® cable **(23)** provided.

Now press the on/off button **(9)** to switch on the measuring tool.

Open the file browser on your computer and select the **GTC 600 C** drive. The saved files can be copied from the internal memory of the measuring tool, moved to your computer or deleted.

As soon as you have finished the required operation, disconnect the drive from the computer following the standard procedure and then use the on/off button **(9)** to switch the measuring tool off again.

Caution: Always disconnect the drive from your operating system first (eject drive), as failure to do so may damage the internal memory of the measuring tool.

Remove the USB Type-C® cable **during** the measuring operation and close the flap **(3)**.

Always keep the flap of the USB port closed so that dust and splashes cannot enter the housing.

Note: Use USB to connect the measuring tool to a computer only. The measuring tool may be damaged if connected to other devices.

Note: The USB Type-C® interface can only be used for data transfer. It is not suitable for charging non-rechargeable and rechargeable batteries.

Post-Editing the Thermal Images

You can post-edit the saved thermal images on your computer if it uses a Windows operating system. To do so, download the GTC Transfer software from the product page for the measuring tool at www.bosch-professional.com.

Data transmission via WLAN

The measuring tool is equipped with a Wi-Fi® interface which enables the saved images taken by your measuring tool to be wirelessly transmitted to a mobile device.

Special Bosch applications (apps) are available for this use. They can be downloaded in the store corresponding to your device:









In addition to the wireless data transfer of your images, the Bosch applications make it possible for you to use an extended range of functions and make it easier to post-edit and forward measured data (e.g. via e-mail). Information about system requirements for a Wi-Fi® connection can be found on the Bosch website at www.bosch-professional.com.

To activate or deactivate the Wi-Fi® connection on the measuring tool, call up the main menu, use the buttons to select **<WiFi>** and activate or deactivate it. The indicator **(e)** appears in the display when the Wi-Fi® is activated. Ensure that the Wi-Fi® interface is activated on your mobile device.

The connection between the mobile device and the measuring tool can be established after the Bosch application has been started (if the Wi-Fi® modules are activated). To do this, follow the instructions in the application (app).

Errors – Causes and Corrective Measures

In the event of a fault, the measuring tool will restart and can then continue to be used. If the fault persists, the following overview may help you.

Error	Cause	Corrective measures
Measuring tool cannot be switched on. 	Battery pack empty	Charge the battery.
	Battery pack too hot or too cold	Allow the battery pack to reach the correct temperature or change it.
	Measuring tool too hot or too cold	Allow the measuring tool to reach the correct temperature.
	Image memory full	Transfer the images to another storage medium (e.g. computer) when necessary. Then delete the images in the internal memory.
	Image memory defective	Format the internal memory by deleting all images. If the problem persists, send the measuring tool to an authorised Bosch after-sales service centre.
	Slow data transfer via Wi-Fi® connection	Change the Wi-Fi® channel (in the main menu via <Tool> → <WiFi Channel>).
	Measuring tool not recognised by computer.	Check whether the driver on your computer is up to date. It may be necessary to have a newer operating system version on your computer.
Measuring tool cannot be connected to a computer.	USB port or USB cable defective	Check whether the measuring tool can be connected to a different computer. If not, send the measuring tool to an authorised Bosch after-sales service centre.
	Coin cell empty	Have the coin cell replaced by Bosch or by an after-sales service centre authorised to work with Bosch power tools.

Error	Cause	Corrective measures
	Measuring tool faulty	Send the measuring tool to an authorised Bosch after-sales service centre.

Glossary of terms

To find out more, visit: www.bosch-professional.com.

Infrared thermal radiation

Infrared thermal radiation is electromagnetic radiation emitted by every body above 0 Kelvin (-273 °C). The amount of radiation depends on the temperature and the emissivity of the body.

Emissivity

The emissivity of an object depends on the material and the structure of its surface. This specifies how much infrared thermal radiation the object emits compared with an ideal radiant warmer (black body, emissivity $\epsilon = 1$) and accordingly has a value between 0 and 1.

Thermal bridge

A thermal bridge is defined as a position on the external wall of a building, where there is a localised increase in heat loss due to a structural defect.

Thermal bridges can lead to an increased risk of mould.

Reflected Temperature/Reflectivity of an Object

The reflected temperature is the thermal radiation that is not emitted by the object itself. Depending on the structure and material, background radiation is reflected in the object to be measured, therefore distorting the actual temperature result.

Distance from the Object

The distance between the object being measured and the measuring tool influences the captured area size per pixel. You can capture increasingly large objects as the distance from the object becomes greater.

Distance (m)	Size of infrared pixels (mm)	Infrared range width × height (m)
0.3	1	0.25 × 0.19
0.55	2	~ 0.46 × 0.35
1	3	~ 0.83 × 0.63
2	6	~ 1.66 × 1.26
5	16	~ 4.14 × 3.15

Maintenance and Service

Maintenance and Cleaning

Only store and transport the measuring tool in a suitable container, such as the original packaging.

Keep the measuring tool clean at all times. A dirty infrared sensor (21) may impair the measuring accuracy.

When cleaning the measuring tool, ensure that no liquids enter the tool.

Do not attempt to remove dirt from the infrared sensor (21), camera (22), speaker (16) or microphone (13) using sharp objects. Do not wipe over the infrared sensor and camera (risk of scratching).

Please contact an authorised Bosch after-sales service centre if you want to have your measuring tool recalibrated. If repairs are required, send in the measuring tool in its original packaging.

There are no parts which can be serviced by the user on the measuring tool. Opening the housing shell can destroy the measuring tool.

Replacing the Built-in Coin Cell

The coin cell replacement must be performed by Bosch or by an after-sales service centre authorised to work with Bosch power tools.

- ▶ **Caution: The coin cell must always be replaced with a coin cell of the same type.** There is a risk of explosion.
- ▶ **Remove and dispose of drained coin cell correctly.** Drained coin cell may leak and damage the product or cause personal injury.

After-Sales Service and Application Service

Our after-sales service responds to your questions concerning maintenance and repair of your product as well as spare parts. You can find explosion drawings and information on spare parts at: www.bosch-pt.com

The Bosch product use advice team will be happy to help you with any questions about our products and their accessories.

In all correspondence and spare parts orders, please always include the 10-digit article number given on the nameplate of the product.

Malaysia

Robert Bosch Sdn. Bhd.(220975-V) PT/SMY
No. 8A, Jalan 13/6
46200 Petaling Jaya
Selangor
Tel.: (03) 79663194
Toll-Free: 1800 880188
Fax: (03) 79583838
E-Mail: kiathoe.chong@my.bosch.com
www.bosch-pt.com.my

You can find further service addresses at:

www.bosch-pt.com/serviceaddresses

Transport

The recommended lithium-ion batteries are subject to legislation on the transport of dangerous goods. The user can transport the batteries by road without further requirements.

When shipping by third parties (e.g.: by air transport or forwarding agency), special requirements on packaging and labelling must be observed. For preparation of the item being shipped, consulting an expert for hazardous material is required.

Dispatch battery packs only when the housing is undamaged. Tape or mask off open contacts and pack up the battery in such a manner that it cannot move around in the packaging. Please also observe the possibility of more detailed national regulations.

Disposal



Measuring tools, rechargeable/non-rechargeable batteries, accessories and packaging should be sorted for environmental-friendly recycling.



Do not dispose of the measuring tools or battery packs/batteries with household waste.

Battery packs/batteries:

Li-ion:

Please observe the notes in the section on transport (see "Transport", page 14).

中文

安全规章



必须阅读并注意所有说明。如果不按照给出的说明使用测量仪，可能会影响集成在测量仪中的保护功能。请妥善保存这些说明。

- ▶ 仅允许由具备资质的专业人员使用原装备件修理测量仪。如此才能够确保测量仪的安全性能。
- ▶ 请勿在有易燃液体、气体或粉尘的潜在爆炸性环境中使用测量仪。测量仪器内可能产生火花并点燃粉尘和气体。
- ▶ 切勿打开充电电池。可能造成短路。
- ▶ 如果充电电池损坏或者未按照规定使用，充电电池中会散发出有毒蒸汽。充电电池可能会燃烧或爆炸。工作场所必须保持空气流通，如果身体有任何不适必须马上就医。蒸汽会刺激呼吸道。
- ▶ 如果充电电池使用不当或者损坏，可能会有易燃的电解液从充电电池中流出。避免与之接触。如果意外碰到，用水冲洗。如果电解液碰到眼睛，还要寻求医疗帮助。从充电电池流出的液体会刺激或灼伤皮肤。
- ▶ 钉子、螺丝刀等尖锐物品或外力作用可能会损坏充电电池。有可能出现内部短路、蓄电池燃烧、发出烟雾、爆炸或过热。
- ▶ 当电池盒不用时，将它远离其他金属物体，例如回形针、硬币、钥匙、钉子、螺钉或其他小金属

物体，以防一端与另一端连接。电池端部短路会引起燃烧或火灾。

- ▶ 只能将此充电电池用在制造商的产品中。这样才能确保充电电池不会过载。
- ▶ 请只用制造商推荐的充电器充电。不可以使用针对某些特定蓄电池的充电器，为其它的蓄电池充电，可能引起火灾。



保护充电电池免受高温（例如长期阳光照射）、火焰、脏污、水和湿气的侵害。有爆炸和短路的危险。



- ▶ 保护好测量仪，尤其是避免红外镜头、扬声器和麦克风区域受到湿气、雨雪、灰尘和脏污的影响。接收镜头可能会蒙上一层雾气或脏污，使测量结果失真。错误的设备设置及其它环境影响因素可能会导致测量错误。显示的物体温度可能会过高或过低，因而当触摸物体时可能会发生危险。
- ▶ 热成像中较高的温度差可能会导致即使温度较高也显示出与低温相关的颜色。触摸这类表面可能会导致烫伤。
- ▶ 只有当设置的辐射率和物体辐射率一致时，才能正确测量温度。显示的物体温度可能会过高或过低，因而当触摸物体时可能会发生危险。
- ▶ 切勿将本测量仪直接对准太阳或 CO₂ 高性能激光器。这可能导致探测器损坏。
- ▶ 请勿将测量仪放到电池上。可能很容易翻倒。从而造成人员受伤。



不要将磁性靠近植入物或其他医疗设备，例如心脏起搏器或胰岛素泵。磁性会产生磁场，这可能会对植入物或医疗设备的功能产生不利影响。

- ▶ 让测量仪远离磁性数据媒体和对磁性敏感的设备。磁性作用可能会导致不可逆的数据损失。
- ▶ 本测量仪装备了一个无线接口。必须注意本地运行限制，例如在飞机上或医院里。



警告



请确保儿童远离纽扣电池。纽扣电池存在安全隐患。

- ▶ 切勿吞咽纽扣电池或使其进入人体。若怀疑吞咽了纽扣电池或电池进入了人体，请立即就医。吞咽纽扣电池可在2小时内造成严重的内部灼伤，甚至死亡。
- ▶ 更换纽扣电池时要注意采用正确的更换方式。有爆炸的危险。
- ▶ 请只使用本用户手册中提及的纽扣电池。请勿使用其他纽扣电池或其他电源。
- ▶ 切勿尝试为纽扣电池充电，切勿短接纽扣电池。纽扣电池可能会泄漏、爆炸、燃烧和造成人身伤害。

- ▶ **请拆下电量耗尽的纽扣电池并对其做恰当的废弃物处理。** 电量耗尽的纽扣电池可能会泄漏，从而损坏产品或造成人身伤害。
- ▶ **纽扣电池不得过热，不可弃置于火中。** 纽扣电池可能会泄露、爆炸、燃烧和造成人身伤害。
- ▶ **不得损坏且不得拆解纽扣电池。** 纽扣电池可能会泄露、爆炸、燃烧和造成人身伤害。
- ▶ **损坏的纽扣电池不得与水接触。** 溢出的锂离子遇水会产生氢气，从而导致火灾、爆炸或人身伤害。
- ▶ **如果纽扣电池支架无法正确以及完全关闭，请勿继续使用测量仪，拆下纽扣电池并让人维修。**

产品和性能说明

请注意本使用说明书开头部分的图示。

按照规定使用

本热成像摄像头用于以非接触方式测量表面温度。显示的热成像显示了热成像摄像头视野范围内的温度分布，因而能够用不同颜色区别显示温度偏差。

这样一来，在正确的使用条件下，本设备能无接触地分析表面和物体的温差或温度异常，使零部件和/或薄弱位置变得可见，例如：

- 隔热和保温层（例如找出热桥），
- 地板和墙壁中的主动导热管或热水管（例如地暖），
- 过热的电气部件（例如保险丝或端子）
- 故障或损坏的机器部件（比如故障的滚珠轴承导致过热）。

本测量仪不适用于测量气体的温度。

不允许使用本测量仪测量人体和动物的温度或用于其他医疗目的。

本测量仪适合在室内和室外使用。

插图上的机件

机件的编号和仪器详解图上的编号一致。

- (1) 可视摄像头和红外线传感器保护盖
- (2) 序列号
- (3) USB插口盖
- (4) Type-C® USB插口^{a)}
- (5) 向上箭头键

- (6) 测量功能键 **Func**
 - (7) 切换温度刻度自动固定/右侧功能键
 - (8) 向右箭头键
 - (9) 电源键
 - (10) 向下箭头键
 - (11) 保存键
 - (12) 向左箭头键
 - (13) 麦克风
 - (14) 图库键/左侧功能键
 - (15) 显示屏
 - (16) 扬声器
 - (17) 电池盒
 - (18) 充电电池解锁按钮^{b)}
 - (19) 充电电池^{b)}
 - (20) 测量暂停/启动按钮
 - (21) 红外线传感器
 - (22) 虚拟摄像头
 - (23) Type-C® USB线
- a) USB Type-C®和USB-C®是USB Implementers Forum的商标。
- b) **图表或说明上提到的附件，并不包含在基本的供货范围中。**

显示元件

- (a) 时间/日期显示
- (b) 平均温度显示
- (c) 反射温度显示
- (d) 辐射率显示
- (e) Wi-Fi®显示已接通/关闭^{a)}
- (f) 蓄电池充电电量指示灯
- (g) 测量范围内表面最高温度显示
- (h) 刻度尺
- (i) 测量范围内表面最低温度显示
- (j) 固定温度刻度图标
- (k) 热点显示（举例）
- (l) 带温度显示的十字线
- (m) 冷点显示（举例）
- (n) 图库图标

a) Wi-Fi®是Wi-Fi Alliance®注册商标。

技术参数

热成像摄像头	GTC 600 C
物品代码	3 601 K83 5..
红外线传感器分辨率	256 × 192像素
温度灵敏性 ^{A)}	≤ 50毫开尔文
自由光谱区	8-14微米
视野 (FOV) ^{B)}	45度 × 35度

热成像摄像头	GTC 600 C
焦距 ^{B)}	≥ 0.3米
焦点	固定
热成像刷新速率	9赫兹
表面温度测量范围 ^{B)}	-20摄氏度至+600摄氏度
表面温度测量精度 ^{B)(C)(D)}	
-20至≤ +10摄氏度	±4摄氏度
> 10至≤ 100摄氏度	±2摄氏度
> +100摄氏度	±2%
温度分辨率	0.1摄氏度
基准高度以上的最大使用高度	2000米
脏污程度符合IEC 61010-1	2 ^{E)}
最大空气相对湿度 ^{B)}	90%
显示屏类型	TFT
显示屏尺寸	3.5"
显示屏分辨率	320 × 240
图片格式	.jpg
音频格式	.wav
每次存储过程的存储元素	1张热成像 (截屏) , 1张虚拟实像, 包括温度值 (元数据) , 必要时还有1条语音备忘
内部图像存储器中的图像数量	600
内部图像存储器中带10秒语音备忘的图像数量	350
内置虚拟摄像头分辨率	640 × 480像素
充电电池 (锂离子)	10.8伏特/12伏特
充电电池 (锂离子) 运行时间 ^{F)(G)}	6小时
USB接头	2.0
电源系统时间	CR2032 (3伏锂离子蓄电池) ^{H)}
无线连接	WLAN
WLAN最大发射功率	< 100毫瓦
WLAN实际最大发射功率	< 20毫瓦
WLAN工作频带	2400-2483.5兆赫
WLAN工作频率范围	2402-2480兆赫
重量符合EPTA-Procedure 01:2014	0.64-0.75公斤 ^{F)}
尺寸 (长 × 宽 × 高)	115 × 102 × 231毫米
保护等级 (充电电池除外, 在竖直位置)	IP54
允许的环境条件	
- 充电时建议的环境温度	0摄氏度至+35摄氏度
- 工作温度	-10摄氏度至+45摄氏度
- 带充电电池存放时	-20摄氏度至+50摄氏度
- 不带充电电池存放时	-20摄氏度至+70摄氏度
推荐的充电电池	GBA 10,8 V GBA 12 V

热成像摄像头

GTC 600 C

推荐的充电器

GAL 12...

GAX 18...

- A) 根据标准VDI 5585 (平均值)
- B) 根据标准VDI 5585
- C) 当环境温度在20摄氏度至23摄氏度之间、辐射率大于0.999、测量距离为0.3米、工作时间大于5分钟、孔径为60毫米时
- D) 加上与使用相关的偏差 (比如反射、距离、环境温度)
- E) 仅出现非导电性污染, 不过有时会因凝结而暂时具备导电性。
- F) 视所使用的充电电池而定
- G) 当环境温度为**20–30**摄氏度时
- H) 必须由博世公司或者经授权的博世电动工具客户服务中心来更换纽扣电池。

使用附带的充电电池所测得的技术数据。

型号铭牌上的序列号(2)是您的测量仪的唯一识别号。

安装

为充电电池充电 (参见插图A)

- ▶ **请只使用在技术参数中列出的充电器。** 只有这些充电器才与可用在本测量仪上的锂离子蓄电池相匹配。

提示: 如果使用的充电电池与测量仪不匹配, 则可能会导致功能失灵或测量仪损坏。

提示: 充电电池在交货时只完成部分充电。首度使用测量仪之前, 必须先充足充电电池的电量以确保充电电池的功率。

可以随时为锂离子电池充电, 不会缩短电池的使用寿命。如果充电过程突然中断, 也不会损坏电池。

如要**装入**已充电的充电电池(19), 请将该电池推入电池仓(17)中, 直至能感觉到它卡入且与测量仪手柄平齐。

如要**取出**充电电池(19), 请按压解锁按键(18), 然后将充电电池从电池仓(17)中拔出。在此过程中请勿过度用力。

运行

- ▶ **不可以让湿气渗入仪器中, 也不可以让阳光直接照射在仪器上。**
- ▶ **请勿在极端温度或温度波动较大的情况下使用测量仪。** 比如请勿将测量仪长时间放在汽车内。温度波动较大的情况下, 使用测量仪之前先使其温度稳定下来。如果仪器暴露在极端的气候下或温差相当大的环境中, 会影响仪器的测量准确度。
- ▶ **注意测量仪正确的气候适应性。** 温度波动较大时, 气候适应时长最多为**60**分钟。比如, 如果将测量仪存放在温度较低的车中, 然后在温暖的建筑中进行测量, 则可能是这种情况。
- ▶ **避免测量仪剧烈碰撞或掉落。** 在发生强烈的外界作用后以及功能异常时, 应将测量仪交由授权的Bosch售后服务点进行检查。

投入使用

接通/关闭

测量时打开保护盖(1)。在工作中请注意不要封闭或遮挡红外线传感器。

如要**接通**测量仪, 请按压电源开关(9)。在显示屏(15)中显示启动序列。启动顺序结束后, 测量仪立刻开始测量并自动连续运行直至关闭。

提示: 在最初几分钟内, 测量仪可能会自动频繁调校, 因为此时传感器温度和环境温度尚未完成匹配。重新调校传感器后可以精确测量。

在这段时间内可以用~标记温度显示。热成像在传感器调校期间会短时冻结。当环境温度剧烈波动时, 该影响加剧。因此, 应尽可能地在开始测量前的几分钟接通测量仪, 使其热稳定。

如要**关闭**测量仪, 请重新按压电源键(9)。测量仪保存所有设置, 然后自动关闭。请合上保护盖(1), 以确保安全运输测量仪。

您可以在主菜单中选择是否以及多久之后自动关闭测量仪(参见“主菜单”, 页 20)。

如果充电电池或测量仪超出技术参数规定的工作温度, 则测量仪在短促警告(参见“故障 - 原因和解决措施”, 页 22)后自动关闭。使测量仪冷却, 然后再次接通。

测量准备

调整表面温度测量的辐射率

物体辐射率取决于其表面的材质和结构。它表示, 与理想的热辐射器 (黑色物体, 辐射率 $\epsilon = 1$) 相比, 该物体发出的红外热辐射量, 数值在0至1之间。

要确定表面温度, 请以非接触方式测量所显示物体发射出的天然红外热辐射。为了确保正确测量, 必须在**每次测量前**检查测量仪上设置的辐射率, 必要时与测量物体进行匹配。

测量仪中预设的辐射率为基准值。

您可以选择一个预设好的辐射率, 或者输入一个具体的数值。通过菜单<测量> → <辐射率>设置所需的辐射率(参见“主菜单”, 页 20)。

- ▶ **只有当设置的辐射率和物体辐射率一致时, 才能正确测量温度。**

辐射率越小，反射温度对测量结果的影响越大。因此，在更改辐射率时务必调整反射温度。通过菜单<测量> → <反射温度>调整反射温度（参见“主菜单”，页 20）。

测量仪显示的假定色差可能是由不同的温度和/或不同的辐射率导致的。如果辐射率差别较大，显示的温差会明显偏离实际温差。

如果测量范围内有不同材料或不同结构的多个测量物体，那么显示的温度值仅对与设定的辐射率相匹配的物体精确。对于所有其它（具有不同辐射率的）物体，显示的色差可以用作温度关系提示。

测量条件提示

高反射或光泽表面（例如光泽的瓷砖或光亮的金属）可能严重影响显示的测量结果或导致其失真。需要时用导热良好的深色亚克力胶带贴住测量面。让胶带短暂地在表面上调温。

对于反射表面请确保良好的测量角度，这样其它物体的反射热辐射不会使测量结果失真。例如，从前面垂直测量时，您自身的体热辐射会影响测量。在测量平整表面时，这样会显示您的身体轮廓和体温（反射值），而非被测表面的本来温度（表面的测得值或实际值）。

原则上，无法穿过透明材料（例如玻璃或透明塑料）进行测量。

测量条件越好越稳定，测量结果就越确切可靠。这不仅与环境条件的温度波动相关，所测物体剧烈的温度波动也会影响精度。

烟、蒸汽/高湿度或含有粉尘的空气将影响红外温度测量。

提高测量精度的提示：

- 请尽可能靠近测量物体，将您与测量表面之间的干扰因素降至最低。
- 在测量前为室内通风，尤其是当空气较脏或有大量水汽时。通风后使房间调温一会儿，直至重新达到常温。

根据刻度匹配温度

显示屏的右侧显示有刻度(h)。上端和下端的数值对应于热成像中测得的最高温度(g)或最低温度(i)。为该刻度尺计算整个像素的99.9%。热成像中颜色与温度值划分是均匀（线性）分配的。

因而可以利用不同的色调在这两个边界值范围内分配温度。正好位于最高值和最低值中心的温度例如已分配给刻度中间的颜色区域。



在测定具体范围的温度时，请移动测量仪，使带有温度显示的十字线(I)对准需要测量的点或范围。在自动设置中，刻度的色谱总是线性（=均匀）地分配在最高和最低温度之间的整个测量范围上。

测量仪显示测量范围内所有测得的温度，相互之间成比例显示。如果在某个范围内，例如在某个彩色显示图内，调色板中的热量显示为淡蓝色，那么说明淡蓝色范围属于当前测量范围内温度相对较低的测量值。但是这些范围却可能处于一个可导致受伤的温度区域内。因此，请始终在刻度表上或直接在十字线上观察显示的温度。

功能

彩色显示的匹配

根据测量情况，不同的调色板可以方便热成像的分析，并清晰地在显示屏上显示物体或实际情况。这不会影响测得的温度。它只改变温度值的显示。

切换调色板时，请停留在测量模式，按压向右箭头键(8)或向左箭头键(12)。

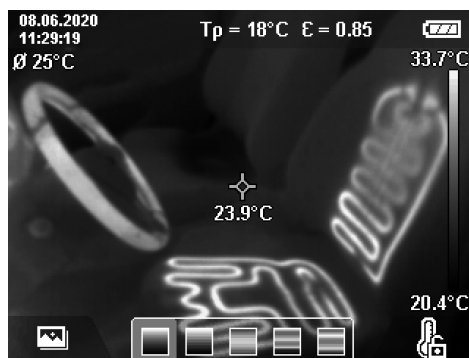

热成像和真实图像重叠

为了更好地定位（=所显示热成像的空间位置匹配），可以在调整好温度范围后另外叠加一张视觉真实图像。

提示：真实图像和热成像的叠加在0.55米的距离上最准确。如果与测量物体的距离存在偏差，则受原理限制，会导致真实图像和热成像偏移。该偏移可以通过GTC Transfer软件进行补偿。

本测量仪具有以下功能：

- **100% 红外图像**
仅显示热成像。
- **画中画**
显示的热成像经过剪裁，四周区域显示真实图像。该设置改进了测量范围的局部分配。
- **透明度**
显示的热成像以透明的形式叠在真实图像上方。这样能够更好地识别物体。

通过按压向上箭头键(5)或向下箭头键(10)，您可以选择该设置。



固定刻度

热成像中的颜色分配是自动进行调整的，但是可以通过按压右侧功能键(7)进行冻结。这样就可以对不同温度条件下测得的热成像进行比较（例如在检测多个空间的热桥时）或者在热成像中隐藏极冷或极热的物体，否则可能会扭曲（比如查找热桥时将散热器测为高温物体）。

如需重新将刻度切换为自动，请再次按下右侧功能键(7)。温度现在重新动态变化，根据测得的最大值和最低值进行调整。

测量功能

如需调用其它可在显示中提供帮助的功能，请按压按钮Func(6)。在显示的选项中用向左箭头键(12)或向右箭头键(8)导航，以选择某个功能。选择一个功能，然后再次按下按钮Func(6)。

有以下测量功能可用：

- <自动>

在热成像中自动进行颜色分配。

- <热态搜索器>

在该测量功能下只会把测量范围内较热的温度显示为热成像。这些较热温度以外的范围将显示为灰阶真实图像。通过灰阶进行显示可以避免将彩色物体错误地与温度联系起来（例如在查找过热的零部件时与电气柜内的红色电缆混淆）。用向上箭头键(5)和向下箭头键(10)调整刻度。这样可以作为热成像放大或缩小显示的温度范围。本测量仪仍然同时测量最低和最高温度，并显示在刻度(h)的两端。

- <冷态搜索器>

在该测量功能下只会把测量范围内较冷的温度显示为热成像。这些较冷温度以外的范围将显示为灰阶真实图像，以免将彩色物体错误地与温度联系起来（例如在查找有问题的绝缘层时与蓝色窗框混淆）。用向上箭头键(5)和向下箭头键(10)调整刻度。这样可以作为热成像放大或缩小显示的温度范围。本测量仪仍然同时测量最低和最高温度，并显示在刻度(h)的两端。

- <手动>

如果热成像中测得的温差较大（例如在检查热桥时将散热器测为高温物体），那么可用的颜色将分布在最高和最低温度之间的众多温度值上。这

可能会导致无法再详细地显示细微的温差。为了能够详尽地显示待检查的温度范围，请按以下方式操作：在切换到<手动>模式后，您可以设置最高或最低温度。这样就可以设定与您相关的温度范围，从而能够识别细微的区别。在<复位标尺>设置中，刻度又可以根据红外传感器视野范围内的测量值自动进行调整。

主菜单

如需进入主菜单，请按下按钮Func(6)，以调出测量功能。现在按下右侧功能键(7)。

- <测量>

▪ <辐射率> (d)

对于若干最常见材料，有已存储的辐射率可供选择。为了简化搜索，这些值在辐射率目录中进了分组。首先在菜单项<材料>下选择合适的类别，然后选择合适的材料。相应辐射率显示在下面一行中。如果您已知测量物体的确切辐射率，也可在菜单项<辐射率>中以数值形式设置该辐射率。

如果经常测量相同的材料，则可以收藏5个辐射率，以便通过顶部栏（从1至5编号）快速调用。

▪ <反射温度> (c)

这个参数的设置可以改善测量结果，特别是对于辐射率较低（=高反射）的材料。在某些情况下（尤其是在室内），反射温度就是环境温度。如果反射强烈的物体附近有温差较大的物体会影响测量，那么应调整该数值。

- <显示>

▪ <中心点> (l)

该点显示在热成像的中间，为您显示此位置上测得的温度值。

▪ <热点> (k): <打开>/<关闭>

在热成像中用红色十字线标记最热点（=测量像素）。这样可以更轻松地查找临界位置（比如开关柜中松动的触点端子）。为了尽可能精确地测量，请将测量物体对焦在显示屏的中心（85 × 64像素）。通过该方式一同显示测量物体的相应温度值。

▪ <冷点> (m): <打开>/<关闭>

在热成像中用蓝色十字线标记最冷点（=测量像素）。这样可以更轻松地查找临界位置（比如窗中的不密封位置）。为了尽可能精确地测量，请将测量物体对焦在显示屏的中心（85 × 64像素）。

▪ <色标> (h): <打开>/<关闭>

▪ <平均温度> (b): <打开>/<关闭>

平均温度(b)显示在热成像的左上方（热成像中所有测得数值的平均温度）。这样可以使您更容易地确定反射温度。

- <WiFi> (e): <打开>/<关闭>

（参见“数据传输”，页 21）

- <设备>

▪ <语言>

在该菜单项下，您可以选择显示中使用的语言。

■ <时间/日期> (a)

如要更改测量仪中的时间和日期，请调出子菜单<时间/日期>。除了调整时间和日期外，还可以在该子菜单中更改其相应的格式。如要离开子菜单<时间>和<日期>，请按压右侧功能键(7)以保存设置或按压左侧功能键(14)以放弃改动。

■ <关闭时间>

您可以在该菜单项中选择测量仪在不按压任何按键时自动关闭的时间间歇。选择设置<切勿>，您也能停用自动关闭。

■ <WiFi频道>

您可以在该菜单项下设置另一个Wi-Fi®通道。

■ <高音频质量>

您可以在该菜单项下调整通过语音备忘记录的音频文件的质量。请注意，较高的音频质量需要更多的存储空间。

■ <设备信息>

您可以在该菜单项下调出关于测量仪的信息。您在这里可找到测量仪的序列号和安装的软件版本。

■ <出厂设置>

您可以通过该菜单项将测量仪恢复到出厂设置以及彻底删除所有数据。这可能需要几分钟。按压<更多>的向右箭头键(8)，以便进入子菜单。然后按压右侧功能键(7)以删除所有文件或按压左侧功能键(14)以取消该过程。

如要退出任一菜单并返回标准显示屏，您也可按压测量按键(20)。

记录测量结果

保存测量结果

测量仪接通后立刻开始测量并连续运行直至关闭。如需保存图像，请将摄像头对准所需的测量物体，然后按下保存键(11)。图像将被保存在测量仪的内部存储器中。也可以按下测量键(20)（暂停）。测量被冻结，并显示在显示屏上。这使您可以仔细查看图像并进行后续调整（例如调色板）。如果不想保存冻结的图像，则可以通过测量键(20)再次启动测量模式。如需将图像保存在测量仪的内部存储器中，请按下保存键(11)。

录制一条语音备忘

如需记录环境条件或有关所存储热成像的附加信息，您可以录制一条语音备忘。除了热成像和虚拟图像外，也会保存该语音备忘并稍后传输。

建议录制一条语音备忘，以确保更好地存档。

在画廊中录制语音备忘。请按如下方式操作：

- 按压左侧功能键(14)，以进入画廊。
- 按压按键Func (6)。开始录制。录制所有相关信息。
- 如要结束录制，请再次按压按键Func (6)或右侧功能键(7)。
- 如要取消录制，请按压左侧功能键(14)。录制后，您可以收听该语音备忘。
- 如要收听录制的内容，请再次按压按键Func (6)。播放录制内容。

- 如要暂停播放，请按压右侧功能键(7)。如要继续播放被暂停的播放，请重新按压右侧功能键(7)。

- 如要停止播放，请按压左侧功能键(14)。

如要录制新的语音备忘，请删除已存在的语音备忘，然后开始录制。

录制时请注意：

- 麦克风(13)位于键盘后面的麦克风图标旁。请对着麦克风的方向说话。
- 最多可以录制30秒。

调取保存的图像

如需调取保存的热成像，请按如下方式操作：

- 按压左侧功能键(14)。现在，显示屏中显示最后保存的图片。
- 按压向右箭头键(8)或向左箭头键(12)，在保存的热成像之间切换。

除了热成像外，还保存了虚拟图像。如要调出该图像，按压向下箭头键(10)。

您可以通过按压向上箭头键(5)将记录的热成像显示为全图像。在全屏视图中，标题栏在3秒钟后隐藏，以便您可以查看热成像的所有详细信息。

您可以通过向上箭头键(5)和向下箭头键(10)切换视图。

删除保存的图像和语音备忘

如需删除特定的热成像或全部的热成像，请进入画廊视图：

- 按下回收站图标下的右侧功能键(7)。子菜单自动打开。您可以在此处选择是否需要删除该图像或相关的语音备忘（如果已录制），或删除全部图像。如果只需删除该图像或语音备忘，请通过按键Func (6)确认该过程。
- 如果需要删除全部图像，请按压按键Func (6)或右侧功能键(7)，并通过右侧功能键(7)确认该过程或通过按压左侧功能键(14)取消删除过程。

图像的数据片段保留在存储器中，可以修复。如要彻底删除，请在主菜单中选择<设备> → <出厂设置>。

数据传输

通过USB接口传输数据

打开Type-C® USB插口的盖子(3)。利用随附的Type-C® USB线(23)将测量仪的Type-C® USB插口(4)与您的计算机连接起来。

现在通过电源开关(9)接通测量仪。

在您的计算机上打开文件浏览器并选择驱动器GTC 600 C。从测量仪内部存储器可复制已存的文件，将其移动到您的计算机上或删除。

一旦所需的过程结束后，请按标准流程将驱动器从计算机上脱开，然后通过电源开关(9)再次关闭测量仪。

注意：请始终先从您的操作系统上移除驱动器（弹出驱动器），否则可能会损坏测量仪的内部存储器。

在测量运行期间，请移除Type-C® USB线，并合上盖板(3)。

请始终保持USB接口盖板关闭，以免灰尘或溅水进入壳体内。

提示：仅可通过USB线将测量仪连接到计算机上。如果连接其他设备，则可能损坏测量仪。

提示：Type-C® USB接口仅用于数据传输。无法为蓄电池和充电电池充电。

热成像的再处理

保存的热成像可以在计算机上Windows操作系统下进行再处理。为此，请在本测量仪的产品网页上下载GTC Transfer软件，网址：
www.bosch-professional.com。

通过WLAN传输数据

本测量仪装备有一个Wi-Fi®接口，可以将保存的图像从测量仪无线传输到移动终端设备上。

提供专用的博世应用程序（APP）供使用。这些应用程序可以根据终端设备在相应的软件商店中下载：











博世应用程序（除了无线传输您的图像数据外）还可以为您扩展功能范围和简化测量数据的再处理及转发（例如通过电子邮件）。关于建立Wi-Fi®连接所需的系统前提条件的信息，可在博世网站上找到：www.bosch-professional.com。

如需激活/关闭测量仪上的Wi-Fi®连接，请调出主菜单，用按键导航，选择<WiFi>，然后将其激活/关闭。Wi-Fi®激活后，显示屏中出现显示(e)。请确保移动终端设备上的Wi-Fi®接口已激活。

启动博世应用程序后（在Wi-Fi®模块已激活的情况下），在移动终端设备和测量仪之间建立连接。为此请遵守应用程序（APP）的指导。

故障 - 原因和解决措施

出现故障时，本测量仪会重启，之后可以再次使用。否则，下列一览表可在持续存在故障信息时为您提供帮助。

故障	原因	解决措施
	充电电池的电量用尽了	请给充电电池充电。
	充电电池过热或过冷	使充电电池冷却或更换充电电池。
	测量仪过热或过冷	让测量仪冷却。
	图像存储器已满	必要时，请将图像传输至另一存储介质（比如计算机）。然后删除内部存储器中的图像。
	图像存储器故障	通过删除所有图像来格式化内部存储器。如果问题仍存在，请将测量仪发送给经授权的博世客户服务中心。
	连接Wi-Fi®时数据传输较慢	切换Wi-Fi®通道（在主菜单的<设备> → <WiFi频道>下）。
	计算机无法识别测量仪。	检查计算机上的驱动程序是否是最新版本。计算机上可能需要更新版本的操作系统。
本测量仪无法与计算机连接在一起。	USB接口或USB线损坏	检查测量仪是否与其他计算机连接在一起。如果未连接在一起，请将测量仪发送给经授权的博世客户服务中心。
	纽扣电池电量耗尽	请让博世公司或者经授权的博世电动工具客户服务中心来更换纽扣电池。
	测量仪损坏	将测量仪发送给经授权的博世客户服务中心。

术语解释

更多信息请参见：
www.bosch-professional.com。

红外热辐射

红外热辐射是每个0开氏度（-273 °C）以上的物体都会发出的电磁辐射。辐射量取决于物体的温度和辐射率。

辐射率

物体辐射率取决于其表面的材质和结构。它表示，与理想的热辐射器（黑色物体，辐射率 $\epsilon = 1$ ）相比，该物体发出的红外热辐射量，数值在0至1之间。

热桥

热桥是建筑物外墙上部的一个部位，在该部位上因结构会导致局部热量损失增加。

热桥可能会导致发霉风险增大。

反射温度/物体反射性

反射温度并非由物体自身发出的热辐射。视结构和材料而定，环境辐射在待测物体上反射，从而使原本的温度结果失真。

物体距离

测量物体和测量仪之间的距离影响了每个像素探测的面积大小。物体距离越大，您可以测量的物体就越大。

距离 (米)	红外像素尺寸 (毫米)	红外范围宽 × 高 (米)
0.3	1	0.25 × 0.19
0.55	2	~ 0.46 × 0.35
1	3	~ 0.83 × 0.63
2	6	~ 1.66 × 1.26
5	16	~ 4.14 × 3.15

维修和服务

维修和清洁

存储和搬运测量仪时，一定要将其放在合适的容器中，比如原包装。

测量仪器必须随时保持清洁。脏污的红外线传感器(21)可能会影响测量精度。

清洁时不允许有液体渗入测量仪中。

切勿尝试用锋利的物体清除红外线传感器(21)、摄像头(22)、扬声器(16)或麦克风(13)上的脏污。切勿擦拭红外线传感器和摄像头（有刮擦的危险）。

如果需要重新校准测量仪，请联系经授权的博世客户服务中心。

需要修理时，请将测量仪装入原包装邮寄。

测量仪内没有用户可以维护的零件。打开壳体可能损坏测量仪。

更换内置纽扣电池

必须由博世公司或者经授权的博世电动工具客户服务中心来更换纽扣电池。

- ▶ **注意：务必用相同型号的纽扣电池来替换旧电池。** 有爆炸的危险。
- ▶ **请拆下电量耗尽的纽扣电池并对其做恰当的废弃物处理。** 电量耗尽的纽扣电池可能会泄漏，从而损坏产品或造成人身伤害。

客户服务和应用咨询

本公司客户服务处负责回答有关本公司产品的修理、维护和备件的问题。备件的展开图纸和信息也可查看：www.bosch-pt.com

博世应用咨询团队乐于就我们的产品及其附件问题提供帮助。

询问和订购备件时，务必提供机器铭牌上标示的10位数物品代码。

中国大陆

博世电动工具（中国）有限公司

中国 浙江省 杭州市

滨江区 滨康路567号

102/1F 服务中心

邮政编码：310052

电话：(0571)8887 5566 / 5588

传真：(0571)8887 6688 x 5566# / 5588#

电邮：bsc.hz@cn.bosch.com

www.bosch-pt.com.cn

制造商地址：

Robert Bosch Power Tools GmbH

罗伯特·博世电动工具有限公司

70538 Stuttgart / GERMANY

70538 斯图加特 / 德国

其他服务地址请见：

www.bosch-pt.com/serviceaddresses

搬运

所推荐的锂离子充电电池必须符合危险物品法规。使用者无须另外使用保护包装便可以运送该充电电池。

但是如果将它交由第三者运送（例如：寄空运或委托运输公司）则要使用特殊的包装和标示。此时必须向危险物品专家请教有关寄送危险物品的相关事宜。

确定充电电池的外壳未受损后，才可以寄送充电电池。粘好未加盖的触点并包装好充电电池，不可以让充电电池在包装中晃动。必要时也得注意各国有关的法规。

处理废弃物



应对测量仪、蓄电池/电池、附件和包装进行环保的回收利用。



请勿将测量仪和电池/蓄电池扔到生活垃圾里。

蓄电池/电池：

锂离子：

请注意 搬运 段落中的指示。（参见“搬运”，页 23）。

产品中有害物质的名称及含量

部件名称	有害物质					
	铅 (Pb)	汞 (Hg)	镉 (Cd)	六价铬 (Cr ⁶⁺)	多溴联苯 (PBB)	多溴二苯醚 (PBDE)
外壳的金属部分	○	○	○	○	○	○
外壳的非金属部分 (包括玻璃)	○	○	○	○	○	○
组合印刷电路板	X	○	○	○	○	○
附件 ^{A)}	X	○	○	○	○	○
键盘	○	○	○	○	○	○
显示器 ^{B)}	○	○	○	○	○	○
内部连接电缆	○	○	○	○	○	○

A) 适用于采用附件的产品

B) 适用于采用显示器的产品

本表是按照SJ/T 11364的规定编制

○：表示该有害物质在该部件所有物质材料中的含量均在GB/T 26572规定的限量要求以下。

X：表示该有害物质至少在该部件的某一物质材料中的含量超出GB/T 26572规定的限量要求，且目前业界没有成熟的替代方案，符合欧盟RoHS指令环保要求。

产品环保使用期限内的使用条件参见产品说明书。

- ▶ 充電電池不使用時，請讓它遠離迴紋針、硬幣、鑰匙、釘子、螺釘或其他小金屬物體，以免造成兩極相接。電池端點短路會引起燃燒或火災。
- ▶ 僅可使用產品的原廠充電電池。如此才可依照產品提供過載保護。
- ▶ 僅能使用製造商規定的充電器進行充電。將適用於某特定電池盒的充電器用於其他電池盒時，可能會造成起火燃燒。



保護充電電池免受高溫（例如長期日照）、火焰、污垢、水液和濕氣的侵害。有爆炸及短路之虞。



- ▶ 請保護測量工具，特別是紅外線感應器、喇叭和麥克風區域，避免沾染濕氣、雪、灰塵和髒污。接收鏡頭可能會起霧或髒污，造成測量結果錯誤。裝置若設定錯誤，或是受到其他天候因素的影響，皆可能導致測量發生錯誤。所顯示的物體溫度可能極高或極低，因此碰觸時可能發生危險。
- ▶ 溫度落差若太大，可能造成熱影像中以代表低溫的顏色顯示高溫。若直接碰觸，人員可能灼傷。
- ▶ 唯有當您所設定的發射率與物體發射率一致時，所測量出來的溫度才會正確。所顯示的物體溫度可能極高或極低，因此碰觸時可能發生危險。
- ▶ 不可將測量工具直接對準太陽或 CO₂ 高性能雷射裝置。這可能造成探測器損壞。
- ▶ 不可將測量工具放置在充電電池上。可能會容易翻覆。掉落可能會導致受傷。



磁鐵不得接近植入裝置或諸如心律調節器或胰島素幫浦等其他醫療器材。磁鐵形成的磁場可能干擾植入裝置或醫療器材運作。

- ▶ 請讓測量工具遠離磁性資料儲存裝置和易受磁場干擾的高靈敏器材。磁鐵所形成的磁場可能造成無法挽救的資料遺失。
- ▶ 本測量工具配備無線介面。請您務必遵守不同場所的使用限制條件，例如在飛機或醫院內。

繁體中文

安全注意事項



您必須完整詳讀本說明書並確實遵照其內容。若未依照現有之說明內容使用測量工具，測量工具內部所設置的防護措施可能無法發揮應有功效。請妥善保存本說明書。

- ▶ 本測量工具僅可交由合格的專業技師以原廠替換零件進行維修。如此才能夠確保本測量工具的安全性。
- ▶ 請不要在存有易燃液體、氣體或粉塵等易爆環境下操作本測量工具。測量工具內部產生的火花會點燃粉塵或氣體。
- ▶ 切勿拆開充電電池。可能造成短路。
- ▶ 如果充電電池損壞了，或者未按照規定使用充電電池，充電電池中會散發出有毒蒸氣。充電電池可能起火或爆炸。工作場所必須保持空氣流通，如果身體有任何不適必須馬上就醫。充電電池散發出的蒸氣會刺激呼吸道。
- ▶ 不當使用或充電電池受損時，充電電池可能會流出可燃液體。請避免接觸。意外沾到時，請用水徹底沖洗。如果液體跑進眼睛裡，請進一步就醫。從電池中滲出的液體可能造成腐蝕或起火。
- ▶ 尖銳物品（例如釘子或螺絲起子）或是外力皆有可能造成充電電池損壞。進而導致內部短路而發生電池起火、冒煙、爆炸或過熱等事故。



警告



請確保鈕扣電池不會落入兒童手中。鈕扣電池相當危險。

- ▶ 不得吞食鈕扣電池或將之放入身體其他孔洞。若有誤食鈕扣電池之疑慮或是不小心讓它經由其他身體部位的開口進入體內，請立刻就醫。若誤食鈕扣電池，2 小時內便可能因體內嚴重腐蝕而致死。
- ▶ 更換鈕扣電池時請注意：應按正確方式替換鈕扣電池。有爆炸危險。
- ▶ 僅能使用本操作說明書所列出的鈕扣電池。切勿使用其他鈕扣電池或供電裝置。
- ▶ 請勿將鈕扣電池重新充電或故意將它接成短路。鈕扣電池可能已非密封狀態，有爆炸、燃燒之虞，人員可能因此受傷。
- ▶ 請將已無電力的鈕扣電池取下並按照規定的程序進行廢棄處置。已無電力的鈕扣電池可能已非密封狀態，產品有損壞之虞或者人員亦可能因此受傷。
- ▶ 勿讓鈕扣電池過熱，禁止將它丟入火中。鈕扣電池可能已非密封狀態，有爆炸、燃燒之虞，人員可能因此受傷。
- ▶ 嚴禁破壞或拆開鈕扣電池。鈕扣電池可能已非密封狀態，有爆炸、燃燒之虞，人員可能因此受傷。
- ▶ 已受損的鈕扣電池不得接觸到水。外洩的鋰一接觸到水就會產生氫氣，現場可能因而失火、爆炸或造成人員受傷。
- ▶ 若無法正確且確實關緊鈕扣電池托架，請勿繼續使用測量工具，請取出鈕扣電池並送交檢修。

產品和功率描述

請留意操作說明書中最前面的圖示。

依規定使用機器

此熱影像鏡頭適合用於非接觸性的表面溫度測量作業。

顯示出來的熱影像即為熱影像鏡頭偵測範圍內的溫度分佈圖，它利用顏色來呈現細微的溫度變化。

應用於專業領域時，不必有任何接觸即可查明表面及物體的溫度落差以及溫度異常，讓您一眼就能看清部件和/或可能存在的破綻，其中包含：

- 隔熱措施與絕緣層（例如發現熱橋現象）、
- 地板與牆面內有水正在流動的熱水管（例如地暖設備）、
- 過熱的電子組件（例如保險絲或端子）、
- 故障或損壞的機器部件（例如因滾珠軸承故障而造成過熱）。

本測量工具不適用於測量氣體溫度。

本測量工具不得用於測量人體或動物的體溫或做為其他醫療用途。

本測量工具可同時適用於室內及戶外應用。

插圖上的機件

機件的編號和儀器詳解圖上的編號一致。

- (1) 攝影鏡頭與紅外線感應器的護蓋
- (2) 序號
- (3) USB 插孔護蓋
- (4) USB Type-C® 插槽^{a)}
- (5) 上方箭頭按鈕
- (6) 測量功能按鈕 **Func**
- (7) 溫度刻度自動與固定模式切換/右側功能按鈕
- (8) 右向箭頭按鈕
- (9) 電源按鈕
- (10) 下方箭頭按鈕
- (11) 儲存按鈕
- (12) 左向箭頭按鈕
- (13) 麥克風
- (14) 圖庫按鈕/左側功能按鈕
- (15) 顯示器
- (16) 喇叭
- (17) 電池盒
- (18) 充電電池解鎖按鈕^{b)}
- (19) 充電電池^{b)}
- (20) 測量暫停/開始按鈕
- (21) 紅外線感應器
- (22) 攝影鏡頭
- (23) USB Type-C® 傳輸線

a) USB Type-C® 和 USB-C® 商標為 USB Implementers Forum 所有。

b) 圖文中提到的配件，並不包含在基本的供貨範圍中。

指示元件

- (a) 日期/時間顯示
- (b) 平均溫度顯示
- (c) 反射溫度顯示
- (d) 發射率顯示
- (e) Wi-Fi® 啟動/關閉顯示^{a)}
- (f) 充電電量指示燈
- (g) 測量範圍最高表面溫度顯示
- (h) 刻度
- (i) 測量範圍最低表面溫度顯示
- (j) 溫度刻度鎖定符號
- (k) 熱點顯示（僅為範例圖示）
- (l) 附帶溫度指示器的十字交叉線
- (m) 冷點顯示（僅為範例圖示）
- (n) 圖庫符號

a) Wi-Fi® 為 Wi-Fi Alliance® 的註冊商標。

技術性數據

熱像儀	GTC 600 C
產品機號	3 601 K83 5..
紅外線感應器解析度	256 × 192 px
熱靈敏度 ^{A)}	≤ 50 mK
頻譜範圍	8–14 μm
可視角 (FOV) ^{B)}	45° × 35°
焦距 ^{B)}	≥ 0.3 m
聚焦	固定式
熱影像畫面更新率	9 Hz
表面溫度測量範圍 ^{B)}	-20 ... +600 °C
表面溫度測量準確度 ^{B)(C)(D)}	
-20 ... ≤ +10 °C	±4 °C
> 10 ... ≤ 100 °C	±2 °C
> +100 °C	±2 %
溫度解析度	0.1 °C
最高適用海拔	2000 m
依照 IEC 61010-1，污染等級為	2 ^{E)}
最大相對空氣濕度 ^{B)}	90 %
螢幕類型	TFT
螢幕尺寸	3.5"
顯示器解析度	320 × 240
圖檔格式	.jpg
音檔格式	.wav
每次執行儲存時實際儲存的元件	1 張熱影像 (螢幕截圖) ， 1 張實景照片，內含溫度值 (中繼資料) ， 必要時 1 份語音備忘錄
內部圖片儲存記憶中的圖片數量	600
內部圖片儲存記憶中各含 10 秒語音備忘錄的圖片數量	350
內建攝影鏡頭解析度	640 × 480 px
充電電池 (鋰離子)	10.8 V / 12 V
充電電池 (鋰離子) 連續工作時間 ^{F)(G)}	6 小時
USB 連接埠	2.0
系統時間供電	CR2032 (3V 鋰電池) ^{H)}
無線連接方式	WLAN
WLAN 最大發射功率	< 20 mW
WLAN 工作頻率範圍	2402–2480 MHz
重量符合 EPTA-Procedure 01:2014	0.64–0.75 kg ^{F)}
尺寸 (長 × 寬 × 高)	115 × 102 × 231 mm
防護等級 (不包含充電電池，於直立位置)	IP54
容許的環境條件	
- 充電狀態下的建議環境溫度	0 ... +35 °C
- 操作溫度	-10 ... +45 °C
- 有充電電池的存放狀態	-20 ... +50 °C

熱像儀	GTC 600 C
– 無充電電池的存放狀態	-20 ... +70 °C
建議使用的充電電池	GBA 10,8 V GBA 12 V
建議使用的充電器	GAL 12... GAX 18...

- A) 符合標準 VDI 5585 (平均值)
 B) 符合標準 VDI 5585
 C) 環境溫度從 20 °C 至 23 °C、發射率 > 0.999、測量距離 0.3 m、操作時間 > 5 分鐘、光圈 60 mm
 D) 加上使用相關的偏差 (例如：反射、距離、環境溫度)
 E) 只產生非傳導性污染，但應預期偶爾因水氣凝結而導致暫時性導電。
 F) 視所使用的充電蓄電池而定
 G) 環境溫度為 **20–30 °C**
 H) 更換鈕扣電池必須由博世客戶服務中心或授權的博世電動工具客戶服務中心進行。
 使用本產品隨附之充電電池時測得的技術性數據。
 從產品銘牌上的序號 (2) 即可識別您的測量工具。

安裝

為充電電池進行充電 (請參考圖 A)

- ▶ 只能選用技術性數據裡所列出的充電器。僅有這些充電器適用於測量工具所使用的鋰離子充電電池。

提示：若是使用非本測量工具適用的充電電池，可能導致測量工具功能異常或損壞。

提示：出貨時充電電池已部分充電。首度使用之前，請先將充電電池充飽電，以確保充電電池的完整功率。

鋰離子充電電池可隨時充電，這樣做並不會縮短電池的使用壽命。如果突然中斷充電，電池也不會損壞。

若要**裝入**已充好電的充電電池 (19)，請將電池推入電池盒 (17)，直到感覺扣入，並齊平緊貼在測量工具把手上。

若要**取出**充電電池 (19)，請按壓解鎖按鈕 (18)，並將充電電池拔出電池盒 (17)。**不可以強行拉出充電電池。**

操作

- ▶ **不可以讓濕氣滲入儀器中，也不可以讓陽光直接照射在儀器上。**
- ▶ **勿讓測量工具暴露於極端溫度或溫度劇烈變化的環境。**例如請勿將它長時間放在車內。測量工具歷經較大溫度起伏時，請先讓它回溫後再使用。如果儀器曝露在極端溫度下或溫差較大的環境中，會影響儀器的測量準確度。
- ▶ **請注意：須讓測量工具完全適應氣候。**溫度劇烈波動時，氣候調適時間可能會長達 **60 分鐘**。例如：若將測量工具放置在冰冷的車上，之後在溫暖的建築物中進行測量時，可能就會出現這種情況。
- ▶ **測量工具須避免猛力碰撞或翻倒。**測量工具遭受外力衝擊後，功能上若有任何異常，則應將它送

交本公司授權的 **Bosch** 客戶服務中心進一步檢修。

操作機器

啟動/關閉

掀開護蓋 (1)，以便進行測量。**執行此項動作時，請注意：不可封住或遮蓋到紅外線感應器。**

若要**啟動**測量工具，請按下電源按鈕 (9)。顯示器 (15) 上會顯示正在啟動。測量工具完成啟動程序後便立即開始進行測量，並將一直持續到關閉電源為止。

提示：一開始的數分鐘，測量工具可能會不斷地自我校正，這是因為感應器還沒適應環境溫度。重新校準感應器可讓您取得精準的測量結果。

在這段期間，溫度指示器可能標示為 ~。感應器校準期間，熱影像會短暫凍結。環境溫度強烈波動時，會加強此效果。因此儘量在測量前數分鐘即開啟測量工具，使其在溫度上穩定。

若要**關閉**測量工具，請再按一次電源按鈕 (9)。本測量工具會先將所有設定儲存起來後才關機。闔上護蓋 (1) 以確保測量工具可安全地進行搬運。

您可到主功能表中選擇，在多久時間後讓測量工具自動關機，或停用此項功能 (參見「主功能表」，頁 29)。

若充電電池或測量工具處於技術規格中所指定的操作溫度之外，則測量工具會在短暫警示 (參見「故障 - 原因和補救方法」，頁 31) 後自動關機。讓測量工具的溫度回溫，然後再重新啟動一次。

測量事前準備

設定表面溫度測量的發射率

測量標的物的發射率根據其材質及表面結構而有所不同。此值代表，相較於理想的熱輻射物體 (即黑體，其發射率 $\epsilon = 1$)，測量標的物所釋放的紅外線熱輻射量，因此為 0 至 1 之間的數值。

表面溫度的判定並不需要接觸測量標的物，而是直接估量該物自然發散的紅外線熱輻射。為確保正確

進行測量，每次測量前都必須檢查測量工具上所設定的發射率，必要時請配合測量標的物進行調整。測量工具內預設的發射率為參考值。

您可以從發射率預設值中挑選，或者直接輸入一個準確的數值。請透過選單 <測量> → <發射率> 設定所需的發射率 (參見「主功能表」, 頁 29)。

► 唯有當您所設定的發射率與物體發射率一致時，所測量出來的溫度才會正確。

發射率越低，反射溫度對測量結果的影響越大。所以變更發射率時，請也務必調整反射溫度。請透過選單 <測量> → <反射溫度> 設定反射溫度 (參見「主功能表」, 頁 29)。

測量工具可能顯示的溫差可能歸因於不同的溫度和/或不同的發射率。因此，如果發射率相差極大，那麼所呈現出來的溫差可能明顯偏離實際情況。如果測量範圍內同時存在多種不同材質或不同結構的測量標的物，那麼所顯示的溫度值僅對適用所設定發射率的物體具有準確性。對於 (擁有不同發射率的) 其他所有物體而言，所顯示的溫差僅可用來參考溫度相對高低。

測量條件的相關注意事項

反射率高的表面或平滑發光的表面 (例如反光瓷磚或裸金屬) 可能會強烈干擾測量或造成測量結果會有誤差。您可視需要用導熱佳的深色非亮面膠帶貼住測量面。然後讓膠帶先閒置一段時間，使它與底下的表面達到均溫。

請注意：如果是會反射的表面，則必須調整至最佳測量角度，不要因為從其他測量標的物反射過來的熱輻射造成測量結果產生誤差。舉例來說，您自身散發的體溫反射可能會干擾到前方的垂直測量。測量平坦表面時，儀器上所顯示的可能是您身體的輪廓及體溫 (反射值)，而不是接受測量之表面的真正溫度 (表面的發射值或實際值)。

原則上，無法穿透過透明材質 (例如玻璃或透明塑膠) 後，測量位於其後方的表面。

測量條件愈佳、愈穩定，其測量結果也就更準確、可信度更高。不僅是大幅度溫度波動具有相關性，所測量物體的大幅溫度變動也可能影響準確度。

煙霧、蒸汽、混濁的空氣或空氣濕度極高時，皆會干擾紅外線溫度測量。

提升測量精準度的技巧：

- 儘可能接近測量標的物，讓您與測量表面之間的干擾因素降至最低。
- 在室內進行測量之前，請先通風，尤其是在空氣髒污或充滿蒸汽的情況下。通風後，請稍待片刻讓室內回溫至正常溫度。

依據刻度尺配置溫度顏色

顯示器的右側可見到刻度尺 (h)。上下兩端的數值即是熱影像中所偵測到的最高溫 (g) 或最低溫 (i)。整體像素的 99.9 % 被用於刻度尺的評算。圖中將依照線性均勻分配代表溫度值的顏色。



透過不同的色調來表達兩個臨界值之間的溫度。因此只要是正好位於最大值與最小值之間的溫度，便可在刻度尺的中間色域中找到它的顏色。

若要測量某一具體區域的溫度，請移動測量工具，讓附溫度顯示的十字交叉線 (I) 對準您想要測量的位置或區域。選擇自動設定時，刻度尺的色譜一律依照整個測量範圍的最高溫和最低溫採線性分配 (即均勻分配)。

測量工具會顯示測量範圍內所有溫度測量值彼此間的相對關係。舉例來說，如果某一區塊以偏藍色調顯示其熱度，這表示在整個實際測量範圍內它偏屬較低溫。但此一區塊的溫度實際上可能已經是會導致人員受傷的高溫。因此，請您隨時留意刻度尺上或是十字交叉線旁所顯示的溫度值。

功能

調整色彩顯示

根據實際測量狀況以不同色域顯示溫度，可讓您更容易分析熱影像，並使顯示器中的物體或真實情況呈現得更加清楚。這樣做並不影響您所測得的溫度值。僅是改變了溫度值的顯示方式而已。

若要切換溫度顯示的色域，請您留在測量模式中，然後按一下右箭頭按鈕 (8) 或左箭頭按鈕 (12)。

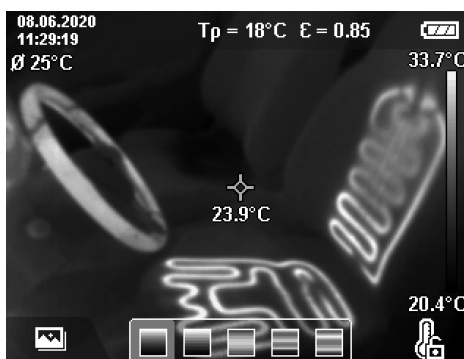

套疊熱影像和實景

在環境已達均溫的情況下，為了方便您定位（即：將顯示的熱影像對照現場位置），可開啟實景影像。

提示：相隔 0.55 m 的距離時，實景和熱影像可精準套疊。與測量物體相隔的距離若不是此值，原則上實景與熱影像可能會有錯位現象。此錯位現象可利用 GTC 傳輸軟體進行校正。

本測量工具提供您以下功能：

- **100 % 紅外線影像**
僅顯示熱影像。
- **子母畫面**
熱影像經裁切後，嵌入在實景中。此設定可改善測量範圍的區域分配。
- **透明化**
熱影像以半透明的方式顯示，其底下是實景影像。此一功能可方便您辨別物體。

您可透過向上 (5) 或向下箭頭按鈕 (10) 選擇設定。



固定刻度尺

熱影像將自動調整配色，但只要按一下右側功能按鈕 (7) 即可凍結設定。如此可以比較在不同溫度條件下所取得的熱影像（例如當檢查多個空間的熱橋效應時），或在熱影像中隱藏極冷或極熱的物體，以免導致變形（例如搜尋熱橋效應時，加熱器視為熱物體）。

若要將刻度尺切換為自動，請再按一次右側功能按鈕 (7)。於是裝置重新改回至動態模式，將配合所測得的最大值及最小值調整溫度顯示方式。

測量功能

如果想要執行其他的顯示輔助功能，請按一下 **Func (6)** 按鈕。利用左箭頭按鈕 (12) 或右箭頭按鈕 (8) 瀏覽顯示的選項，以便選擇一項功能。選取功能後，請再按一次按鈕 **Func (6)**。

以下是供您選用的測量功能：

- **<自動>**
熱影像將自動調整配色。
- **<熱偵測器>**
此一測量功能將使熱影像僅顯示測量範圍中較高溫的部份。高溫部份以外的範圍將以灰階實景顯示。灰階顯示可避免有顏色物體與溫度的錯誤關

聯（例如尋找過熱組件時，機電箱內的紅色電線）。使用向上 (5) 和向下箭頭按鈕 (10) 調整刻度尺。所顯示的溫度範圍，可利用熱感圖拉大或縮小。測量工具仍將同時測量最高溫及最低溫，並將它們顯示於刻度尺 (h) 的兩端。

- **<低溫偵測器>**
此一測量功能將使熱影像僅顯示測量範圍中較低溫的部份。低溫部份以外的範圍將以灰階實景顯示，於是從顏色便可正確判斷物體的溫度（例如：追查絕緣不良處時顯示為藍色的窗框）。使用向上 (5) 和向下箭頭按鈕 (10) 調整刻度尺。所顯示的溫度範圍，可利用熱感圖拉大或縮小。測量工具仍將同時測量最高溫及最低溫，並將它們顯示於刻度尺 (h) 的兩端。
- **<手冊>**
如果熱影像中所測得的溫度落差極大（例如：探查熱橋現象時，高溫物體視為加熱裝置），最大與最小值之間的大量的溫度數值，會共同分配到可用的顏色。於是畫面上很可能就無法區別出細微的溫差。為能詳細顯示待檢查的溫度範圍，請按照下列步驟操作：切換到 **<手冊>** 模式後，即可設定最高或最低溫度。此一方法可讓您將溫度範圍指定在想要追看細微溫差的相關範圍。利用 **<重設刻度>** 設定，即可讓刻度尺重新自動配合紅外線感應器偵測範圍內所測得的數值進行調整。

主功能表

如要進入主功能表，先按一下按鈕 **Func (6)**，以調出測量功能。現在請按一下右側功能按鈕 (7)。

- **<測量>**
 - **<發射率> (d)**
本產品中已預先儲存了一些最常見材質的發射率供您選擇。為方便搜尋，發射率目錄中已分組彙整了數值。請先在選單項目 **<材質>** 中選擇合適的類別，然後再選擇合適的材料。其下便是該材質的發射率。如果已知道測量標的物的準確發射率，則可直接在選單項目 **<發射率>** 中設定此數值。
若須經常測量相同材料，可將 5 種發射率設為最愛設定，即可透過最上方列（編號 1 至 5）快速開啟。
 - **<反射溫度> (c)**
設定此參數可提升測量品質，特別是測量低發射率材質（= 高反射率）時。在部分情況（特別是在室內）下，反射溫度等於環境溫度。高反射性物件附近若有溫度落差大的物體，這些物體可能會影響到測量，應調整此數值的設定。
- **<顯示>**
 - **<中心點> (l)**
該點顯示在熱影像的中央，並為您顯示該位置所測得的溫度值。
 - **<熱點> (k): <開>/<關>**
最熱點（= 測量像素）在熱影像中被標記為紅色十字交叉線。這樣可以更輕鬆地搜尋關鍵位置（例如機電箱中鬆動的接觸夾）。為了獲得最準確的測量結果，請將測量物體聚焦在顯示

器的中央 (85 × 64 px)。如此便可顯示該測量物體的相關溫度值。

- **<冷點> (m): <開>/<關>**

最冷點 (= 測量像素) 在熱影像中被標記為藍十字交叉線。這樣可以更輕鬆地搜尋關鍵的位置 (例如窗戶的洩漏處)。為了獲得最準確的測量結果, 請將測量物體聚焦在顯示器的中央 (85 × 64 px)。

- **<色階> (h): <開>/<關>**

- **<平均溫度> (b): <開>/<關>**

平均溫度 (b) 顯示於熱影像左側 (所有熱影像中已測得數值的平均溫度)。這樣可以使您更容易確定反射溫度。

- **<WiFi> (e): <開>/<關>**

(參見「資料傳輸」, 頁 31)

- **<裝置>**

- **<語言>**

您可在該選單項目選擇指示器示中所使用的語言。

- **<時間與日期> (a)**

若要變更測量工具中的時間和日期, 請開啟子選單 **<時間與日期>**。在該子選單中, 您除了可以變更時間和日期外, 也可以設定其格式。若要退出子選單 **<時間>** 和 **<日期>**, 請按下右側功能按鈕 (7) 儲存設定, 或按下左側功能按鈕 (14) 捨棄變更。

- **<關機時間>**

您可在此選單項目下選擇, 在未按下任何按鈕的時間持續多久後, 讓測量工具自動關機。您也可以選擇此設定 **<永不>**, 來停用自動關機功能。

- **<WiFi 頻道>**

您可在此選單項目下調整其他的 Wi-Fi® 頻道。

- **<高音訊品質>**

您可在此選單項目下調整語音備忘錄所錄取語音檔案的品質。請注意, 更高音質需要更多的儲存位置。

- **<裝置資訊>**

您可在此選單項目下調出本測量工具的相關資訊。您可在此處找到測量工具的序號及其安裝的軟體版本。

- **<恢復預設>**

您可在此選單項目下將測量工具重置為原廠設定, 並永久刪除所有資料。這可能需要數分鐘時間。按下 **<其他>** 的右箭頭按鈕 (8), 即可進入子選單。然後再按下右側功能按鈕 (7), 以刪除全部檔案, 或按下左側功能按鈕 (14), 取消程序。

若要退出任一選單, 並返回標準顯示螢幕, 亦可按下測量按鈕 (20)。

測量結果文檔

儲存測量結果

測量工具啟動後便會直接開始進行測量, 並將一直持續到關閉電源為止。

若要儲存圖片, 請將攝影鏡頭對準測量標的物, 然後按一下儲存按鈕 (11)。圖片將存放在測量工具的內部記憶體中。或者按一下測量按鈕 (20) (暫

停)。系統隨即凍結測量程序, 並在顯示器上顯示相關內容。這使您可以仔細查看圖片並進行後續調整 (例如色域)。如果您不想儲存這張凍結的圖片, 請使用按鈕 (20) 重新回到測量模式。如果想將這張圖片儲存至測量工具的內部記憶體, 請按一下儲存按鈕 (11)。

錄製語音備忘錄

您可以錄製一段語音備忘錄, 以記錄環境條件或有關所儲存熱影像的額外資訊。這會隨著熱影像和實景照片一起儲存, 並在之後傳輸。

為確保更完善的資料紀錄, 建議錄製語音備忘錄。

語音備忘錄的錄製在圖庫中進行。請如下進行:

- 若要進入主選單, 請按下左側功能按鈕 (14)。
- 按一下按鈕 **Func (6)**。錄製開始。錄製所有相關資訊。
- 若要**結束**錄音, 請再次按下按鈕 **Func (6)**, 或右側功能按鈕 (7)。
- 若要**中斷**錄音, 請按下左側功能按鈕 (14)。您可在錄製後聽取語音備忘錄。
- 若要**聽取**錄音, 請重新按下按鈕 **Func (6)**。即可播放錄音。
 - 若要**暫停**播放, 請按下右側功能按鈕 (7)。若要重新播放已暫停的錄音, 請重新按下右側功能按鈕 (7)。
 - 若要**停止**播放, 請按下左側功能按鈕 (14)。

若要錄製一段新的語音備忘錄, 請刪除原有的語音備忘錄, 然後開始新的錄音。

錄音時請注意:

- 麥克風 (13) 位於鍵盤後方的麥克風符號旁。請朝著麥克風方向說話。
- 最長錄音時間為 30 秒。

開啟已儲存的圖片

若要開啟已儲存的熱影像, 請按以下方式操作:

- 按一下左側功能按鈕 (14)。顯示器中隨即顯示最後儲存的縮圖。
- 按一下右箭頭按鈕 (8) 或左箭頭按鈕 (12), 即可在已儲存的熱影像之間進行切換。

實景照片也會隨著熱影像共同儲存。如要將其調出, 請按向下箭頭按鈕 (10)。

您可以按向下箭頭按鈕 (5) 來將所儲存的熱影像顯示為實景照片。在全圖檢視模式時, 標題列在 3 秒鐘後消失, 讓您可觀察熱影像的所有細節。

您可使用向上箭頭按鈕 (5) 和向下箭頭按鈕 (10) 切換檢視方式。

刪除已儲存的圖片和語音備忘錄

若要刪除單張或全部熱影像, 請切換到圖庫檢視方式:

- 按一下垃圾桶圖示底下的右側功能按鈕 (7)。隨即開啟一個子選單。您可在此選擇, 僅刪除此圖片、僅刪除其所有語音備忘錄 (如有錄製) 或刪除所有圖片。如果您只想刪除此圖片或語音備忘錄, 請按下按鈕 **Func (6)** 確認此程序。
- 如果您想刪除所有圖片, 請按下按鈕 **Func (6)** 或右側功能按鈕 (7), 在以右側功能按鈕 (7) 確

認此程序，或按下左側功能按鈕 (14) 中斷刪除程序。

圖片的數據片段保留在記憶體中，並可以重建。您可在主功能表 <裝置> → <恢復預設> 中選擇永久刪除。

資料傳輸

透過 USB 連接介面傳輸資料

打開 USB Type-C® 插孔護蓋 (3)。將測量工具的 USB Type-C® 插孔 (4) 透過隨附的 USB Type-C® 傳輸線 (23) 與您的電腦連接。

現在即可按下電源按鈕 (9)，啟動本測量工具。

打開電腦上的檔案瀏覽器，選擇磁碟機

GTC 600 C。即可從測量工具的內部記憶體複製已儲存的檔案、將檔案移至電腦或刪除。

完成所需程序後，請立即按標準程序斷開磁碟機與電腦的連線，然後利用電源按鈕 (9) 重新關閉測量工具。

注意：請先將磁碟機從作業系統卸除（退出磁碟機），否則測量工具的內部記憶體可能會受損。

在測量操作期間，拔下 USB Type-C® 傳輸線，並關上護蓋 (3)。

USB 介面的保護蓋板請隨時保持關閉，這樣才不會有灰塵或噴濺的液體跑進機殼內。

提示：透過 USB 僅能將測量工具與電腦連接。若與其他裝置連接，測量工具可能會受損。

提示：USB Type-C® 介面僅用於資料傳輸。電池或充電電池不可使用此介面進行充電。

熱影像進行後製加工

以儲存的熱影像可在安裝 Windows 的電腦上進行後製加工。若要這麼做，請到測量工具的產品網站上下載 GTC 傳輸軟體，網址：
www.bosch-professional.com。

透過 WLAN 傳輸資料

本測量工具配備 Wi-Fi® 介面，可將所儲存圖片從測量工具無線傳輸至行動終端裝置。

其可使用專門的博世應用程式 (App) 來進行此功能。您可到相關商店按照所使用的終端裝置下載該程式：









透過博世應用程式可擴充功能範圍（除了圖片無線傳輸以外），還能簡化測量資料的後置加工和轉發作業（例如：透過電子郵件）。如需 Wi-Fi® 連線的系統需求相關資訊，請至博世網站：
www.bosch-professional.com。



若要啟用/停用測量工具上的 Wi-Fi® 連線，請開啟主選單，利用按鈕進入 <WiFi> 選項，然後在此啟用/停用此項功能。Wi-Fi® 啟用時，在顯示器上會隨即顯示 (e)。請確認：終端行動裝置上的 Wi-Fi® 介面已啟用。

博世應用程式啟動之後，（在 Wi-Fi® 模組已啟用的狀態下）即可在終端行動裝置與測量工具之間建立連線。為此請遵循應用程式 (App) 的指示。

故障 - 原因和補救方法

若發生故障，本測量工具將重新啟動，然後便可重新使用。萬一持續出現故障訊息時，以下列出的一覽表將可為您提供協助。

故障	原因	補救措施
	測量工具無法啟動。	充電電池的電量耗盡 請為充電電池充電。
	充電電池溫度太高或太低	讓充電電池溫度回溫或更換電池。
	測離工具溫度太高或太低	讓測量工具進行降溫。
	圖片儲存記憶體已滿	必要時，將圖片傳輸至另一個記憶體媒體（例如電腦）。然後刪除內部記憶體的圖片。
	圖片儲存記憶體故障	刪除全部圖片，以進行內部記憶體格式化。若問題依舊存在，請將測量工具寄至授權的博世客戶服務中心。
	Wi-Fi® 連線時資料傳輸緩慢	更換 Wi-Fi® 頻道（在主選單的 <裝置> → <WiFi 頻道> 下）。
	電腦無法偵測到測量工具。	請檢查電腦上的驅動程式是否為最新版本。必要時可能必須更新電腦上的作業系統版本。
	不可將測量工具與電腦連線。	USB 連接埠或 USB 傳輸線故障 請檢查，測量工具是否能與另一台電腦連接。若不能，請將測量工具寄至授權的博世客戶服務中心。

故障	原因	補救措施
	鈕扣電池電力耗盡	請由博世或授權的博世電動工具客戶服務中心更換鈕扣電池。
	測量工具故障	將測量工具寄至授權的博世客戶服務中心。

名詞解釋

您可在 www.bosch-professional.com 找到更多資訊。

紅外線熱輻射

紅外線熱輻射高於 0 Kelvin (-273 °C) 是一種人體散發出來的電磁輻射。其輻射量視人體的溫度和發射率而定。

發射率

測量標的物的發射率根據其材質及表面結構而有所不同。此值代表，相較於理想的熱輻射物體（即黑體，其發射率 $\epsilon = 1$ ），測量標的物所釋放的紅外線熱輻射量，因此為 0 至 1 之間的數值。

熱橋效應

熱橋效應係指建築物外壁一處因結構因素出現局部熱損失增加的情況。

熱橋現象可能提高發霉的風險。

反射溫度 / 物體的反射特性

所謂反射溫度係指非物體自身發散的熱輻射。視結構和材料而定，待測量物件內的環境輻射會反射，因而影響到實際的溫度結果。

物體距離

測量標的物與測量工具相隔的距離將影響每一像素所偵測的面積大小。與物體之間的距離愈長，您可偵測的物體就愈大。

距離 (m)	紅外線像素尺寸 (mm)	紅外線範圍，寬 x 高 (m)
0.3	1	0.25 × 0.19
0.55	2	~ 0.46 × 0.35
1	3	~ 0.83 × 0.63
2	6	~ 1.66 × 1.26
5	16	~ 4.14 × 3.15

維修和服務

維修和清潔

儲放與運送測量工具時，請務必將它放入適當的容器內，例如原廠包裝盒。

測量儀器必須隨時保持清潔。髒污的紅外線感應器 (21) 可能會影響測量準確度。

進行清潔時，切勿讓任何液體滲入測量工具。

請勿嘗試用尖銳的物體清除紅外線傳感器 (21)、攝影鏡頭 (22)、喇叭 (16) 或麥克風 (13) 上的污垢。

請勿在紅外線感應器和攝影鏡頭上擦拭 (刮傷風險)。

若希望重新校正您的測量工具，請洽詢授權的博世客戶服務中心。

如需送修，請將測量工具放入原廠包裝盒內後，再轉交給相關單位。

在測量工具內沒有使用者可維護的組件。任意拆開測量工具外殼，可能導致其毀損。

更換內建式鈕扣電池

更換鈕扣電池必須由博世客戶服務中心或授權的博世電動工具客戶服務中心進行。

▶ **注意：務必以同類型的鈕扣電池更換之。** 有爆炸危險。

▶ **請將已無電力的鈕扣電池取下並按照規定的程序進行廢棄處置。** 已無電力的鈕扣電池可能已非密封狀態，產品有損壞之虞或者人員亦可能因此受傷。

顧客服務處和顧客諮詢中心

本公司顧客服務處負責回答有關本公司產品的維修、維護和備用零件的問題。以下的網頁中有分解圖和備用零件相關資料：www.bosch-pt.com 如果對本公司產品及其配件有任何疑問，博世應用諮詢小組很樂意為您提供協助。

當您需要諮詢或訂購備用零件時，請務必提供本產品型號銘牌上 10 位數的產品機號。

台灣

台灣羅伯特博世股份有限公司

建國北路一段90號6樓

台北市10491

電話: (02) 7734 2588

傳真: (02) 2516 1176

www.bosch-pt.com.tw

制造商地址:

Robert Bosch Power Tools GmbH

羅伯特·博世電動工具有限公司

70538 Stuttgart / GERMANY

70538 斯圖加特/德國

以下更多客戶服務處地址:

www.bosch-pt.com/serviceaddresses

搬運

建議使用的鋰離子充電電池受危險物品法的規範。使用者無須另外使用保護包裝便可運送該充電電池。

但是如果將它交由第三者運送（例如：寄空運或委託運輸公司），則應遵照包裝與標示的相關要求。此時必須向危險物品專家請教有關寄送危險物品的相關事宜。

確定充電電池的外殼未受損後，才可以寄送充電電池。用膠帶貼住裸露的接點並妥善包裝充電電池，不可以讓充電電池在包裝材料中晃動。同時也應留意各國相關法規。

廢棄物處理



測量工具、充電電池／拋棄式電池、配件以及包裝材料須遵照環保相關法規進行資源回收。



不得將本測量工具與充電電池／拋棄式電池丟入家庭垃圾中！

充電電池／一般電池：

鋰離子：

請注意「搬運」段落中的指示（參見「搬運」，頁 32）。

有關台灣的更多資訊

NCC 警語

低功率射頻器材管理辦法:

取得審驗證明之低功率射頻器材，非經核准，公司、商號或使用者均不得擅自變更頻率、加大功率或變更原設計之特性及功能。

低功率射頻器材之使用不得影響飛航安全及干擾合法通信；經發現有干擾現象時，應立即停用，並改善至無干擾時方得繼續使用。

前述合法通信，指依電信管理法規定作業之無線電通信。

低功率射頻器材須忍受合法通信或工業、科學及醫療用電波輻射性電機設備之干擾。

공구에 분진이나 증기를 접화하는 스파크가 생길 수 있습니다.

- ▶ **배터리를 분해하지 마십시오.** 단락이 발생할 위험이 있습니다.
- ▶ **배터리가 손상되었거나 잘못 사용될 경우 증기가 발생할 수 있습니다. 배터리에서 화재가 발생하거나 폭발할 수 있습니다.** 작업장을 환기시키고, 필요한 경우 의사와 상담하십시오. 증기로 인해 호흡기가 자극될 수 있습니다.
- ▶ **배터리를 잘못 사용하거나 배터리가 손상된 경우, 배터리에서 가연성 유체가 흘러나올 수 있습니다.** 누수가 생긴 배터리에 닿지 않도록 하십시오. 피부에 접하게 되었을 경우 즉시 물로 씻으십시오. 유체가 눈에 닿았을 경우 바로 의사와 상담하십시오. 배터리에서 나오는 유체는 피부에 자극을 주거나 화상을 입힐 수 있습니다.
- ▶ **못이나 스크류 드라이버 같은 뾰족한 물체 또는 외부에서 오는 충격 등으로 인해 축전지가 손상될 수 있습니다.** 내부 단락이 발생하여 배터리가 타거나 연기가 발생하고, 폭발 또는 과열될 수 있습니다.
- ▶ **배터리를 사용하지 않을 때는 각 극 사이에 브리징 상태가 생길 수 있으므로 페이퍼 클립, 동전, 열쇠, 못, 나사 등 유사한 금속성 물체와 멀리하여 보관하십시오.** 배터리 극 사이에 쇼트가 일어나 화상을 입거나 화재를 야기할 수 있습니다.
- ▶ **제조사외의 배터리 제품만 사용하지 마십시오.** 그레야만 배터리 과부하의 위험을 방지할 수 있습니다.
- ▶ **배터리는 제조사에서 권장하는 충전기에서만 충전하십시오.** 특정 제품의 배터리를 위하여 제조된 충전기에 적합하지 않은 다른 배터리를 충전할 경우 화재 위험이 있습니다.



배터리를 태양 광선 등 고열에 장시간 노출되지 않도록 하고 불과 오염물질, 물, 수분이 있는 곳에 두지 마십시오. 폭발 및 단락의 위험이 있습니다.



- ▶ **본 측정공구는 특히 적외선 렌즈, 스피커 및 마이크 영역에 습기, 강설, 먼지 및 오염물이 유입되지 않도록 하십시오.** 수신 렌즈에 선애가 끼거나 오염 물질이 묻으면 측정 결과가 왜곡될 수 있습니다. 장치 설정이 올바르게 맞고 기타 대기적 요인으로 인해 잘못된 측정이 유발될 수 있습니다. 측정 객체의 온도가 너무 높게 혹은 너무 낮게 나타날 수 있으며, 이러한 경우 접촉하게 되면 위험할 수 있습니다.
- ▶ **열 이미지 내에서 온도 차이가 너무 크면, 온도가 높더라도 낮은 온도와 연관된 색상으로 표시될 수 있습니다.** 이러한 표면에 접촉하면 화상을 입을 수 있습니다.
- ▶ **온도는 설정된 방사율과 대상의 방사율이 일치할 때만 정확하게 표시됩니다.** 측정 객체의 온도가 너무 높게 혹은 너무 낮게 나타날 수 있으며, 이러한 경우 접촉하게 되면 위험할 수 있습니다.
- ▶ **측정공구가 직접적으로 태양이나 CO₂ 고성능 레이저를 향하게 하지 마십시오.** 감지기가 손상될 수 있습니다.

한국어

안전 수칙



제시된 모든 지침을 숙지하고 이를 준수해야 합니다. 측정공구를 해당 지침에 따라 사용하지 않으면, 측정공구에 내장되어 있는 안전장치에 안 좋은 영향을 미칠 수 있습니다. 본 설명서를 잘 보관하시기 바랍니다.

- ▶ **측정공구의 수리는 해당 자격을 갖춘 전문 인력에게 맡기고, 수리 정비 시 순정 부품만 사용하십시오.** 이 경우에만 측정공구의 안전성을 오래 유지할 수 있습니다.
- ▶ **가연성 유체나 가스 혹은 분진 등 폭발 위험이 있는 곳에서 측정공구를 사용하지 마십시오.** 측정

- ▶ 측정공구를 배터리 위에 세워 두지 마십시오. 측정공구가 쉽게 기울어집니다. 아래로 떨어지면서 부상을 입을 수 있습니다.



자석을 심장 박동 조절장치 또는 인슐린 펌프와 같은 삽입물 또는 기타 의학 기기 근처로 가져오지 마십시오. 자석으로 인해 자기장이 형성되어 삽입물 또는 의학 기기의 기능에 장애를 일으킬 수 있습니다.

- ▶ 측정공구를 자기 데이터 매체나 자력에 예민한 기기에서 멀리 두십시오. 자석의 영향으로 인해 데이터가 손실되어 복구 불가능할 수 있습니다.
- ▶ 해당 무선설비는 전파혼신 가능성이 있으므로 인명안전 과 관련된 서비스는 할 수 없습니다.
- ▶ 측정공구에는 무선 인터페이스가 장착되어 있습니다. 비행기나 병원 등 장소에 따른 제약에 주의하십시오.



경고



동전형 배터리를 어린이 혼자 사용하지 않도록 하십시오. 동전형 배터리는 위험합니다.

- ▶ 동전형 배터리를 삼키거나 다른 경로를 통해 인체에 유입되는 일이 절대 없도록 하십시오. 동전형 배터리를 삼켰거나 다른 경로를 통해 인체에 유입된 것으로 의심되는 경우 즉시 의사와 상담하십시오. 동전형 배터리가 인체에 들어가면 2시간 내에 심각한 부상을 일으키고 사망을 초래할 수 있습니다.
- ▶ 동전형 배터리 교환 시 올바른 방법으로 동전형 배터리를 교환하십시오. 폭발 위험이 있습니다.
- ▶ 본 설명서에 제시된 동전형 배터리만 사용하십시오. 다른 동전형 배터리 또는 다른 에너지 공급원을 사용하지 마십시오.
- ▶ 수은전지를 재충전하지 말고 합선을 피하십시오. 수은전지가 누수되어 폭발, 화재 및 상해를 유발할 수 있습니다.
- ▶ 방전된 수은전지는 규정에 맞게 제거한 후 폐기하십시오. 방전된 수은전지는 누수될 수 있으며 이는 인체나 제품에 해를 끼칠 수 있습니다.
- ▶ 수은전지의 과열을 방지하고 불에 가까이 하지 마십시오. 수은전지가 누수되어 폭발, 화재 및 상해를 일으킬 수 있습니다.
- ▶ 수은전지를 손상시키거나 분리하지 마십시오. 수은전지가 누수되어 폭발, 화재 및 상해를 일으킬 수 있습니다.
- ▶ 손상된 수은전지에 물이 닿지 않도록 하십시오. 리튬이 누수되어 화재 또는 폭발이 일어나거나 이로 인하여 부상을 입을 수 있습니다.
- ▶ 동전형 배터리의 고정부가 올바르게 제대로 닫히지 않는 경우, 더 이상 측정공구를 사용하지 말고, 동전형 배터리를 제거한 후 수리 받으십시오.

제품 및 성능 설명

사용 설명서 앞 부분에 제시된 그림을 확인하십시오.

규정에 따른 사용

본 열화상 카메라는 비접촉식 표면온도 측정 용도로 사용됩니다.

열화상 카메라 시야에 있는 온도 분포를 열 이미지로 표시해서 온도 편차를 색상으로 구분할 수 있게 해줍니다.

해당 용도에 맞춰 전문적으로 사용할 때 표면 및 물체의 온도 차이 및 온도 특이점을 조사하여, 특히 다음과 같은 구성품 및/또는 존재할 수 있는 취약 부위를 가시화할 수 있습니다.

- 단열재 및 절연재(예: 열교 감지)
- 바닥 또는 벽에서 가동 중인 난방 온수관(예: 바닥 난방장치)
- 과열된 전기 부품(예: 퓨즈 또는 단자)
- 고장 또는 손상이 있는 기계 부품(예: 고장난 볼 베어링으로 인한 과열).

본 측정공구는 기체의 온도 측정에는 적합하지 않습니다.

사람이나 동물의 체온을 측정하거나, 기타 의학적으로 사용해서는 안 됩니다.

측정공구는 실내 및 실외에서 모두 사용할 수 있습니다.

제품의 주요 명칭

제품의 주요 명칭에 표기되어 있는 번호는 측정공구의 그림이 나와있는 면을 참고하십시오.

- (1) 광학 카메라 및 적외선 센서용 보호캡
- (2) 일련 번호
- (3) USB 포트 커버
- (4) USB Type-C® 포트^{a)}
- (5) 위쪽 화살표 버튼
- (6) 측정 기능 버튼 **Func**
- (7) 온도 눈금 변경 자동 - 고정/오른쪽 기능 버튼
- (8) 오른쪽 화살표 버튼
- (9) 전원 버튼
- (10) 아래쪽 화살표 버튼
- (11) 저장 버튼
- (12) 왼쪽 화살표 버튼
- (13) 마이크
- (14) 갤러리 버튼/왼쪽 기능 버튼
- (15) 디스플레이
- (16) 스피커
- (17) 배터리 슬롯
- (18) 배터리 해제 버튼^{b)}
- (19) 배터리^{b)}
- (20) 측정 일시정지/시작 버튼
- (21) 적외선 센서

(22) 광학 카메라

(23) USB Type-C® 케이블

- a) USB Type-C® 및 USB-C®는 USB Implementers Forum의 상표입니다.
- b) **도면이나 설명서에 나와있는 액세서리는 표준 공급부품에 속하지 않습니다.**

표시 요소

- (a) 날짜/시간 표시기
- (b) 평균 온도 표시기
- (c) 반사 온도 표시기
- (d) 방사를 표시기

(e) Wi-Fi® 켜짐/꺼짐 표시기^{a)}

(f) 충전상태 표시기

(g) 측정 영역 내 표면 최고 온도 표시기

(h) 눈금자

(i) 측정 영역 내 표면 최저 온도 표시기

(j) 온도 눈금 고정 기호

(k) 열점 표시기(예시)

(l) 온도 표시기가 포함된 십자선

(m) 냉점 표시기(예시)

(n) 갤러리 기호

a) Wi-Fi®는 Wi-Fi Alliance®의 등록 상표입니다.

제품 사양

열화상 카메라	GTC 600 C
품번	3 601 K83 5..
적외선 센서 해상도	256 × 192 px
열 민감도 ^{A)}	≤ 50 mK
스펙트럼 영역	8-14 μm
시야(FOV) ^{B)}	45° × 35°
초점 거리 ^{B)}	≥ 0.3 m
포커스	고정
열 이미지 재생률	9 Hz
표면 온도 측정 영역 ^{B)}	-20 ... +600 °C
표면 온도 정확도 ^{B)(C)(D)}	
-20 ... ≤ +10 °C	±4 °C
> 10 ... ≤ 100 °C	±2 °C
> +100 °C	±2 %
열 분해능	0.1 °C
기준 높이를 초과한 최대 사용 높이	2000 m
IEC 61010-1에 따른 오염도	2 ^{E)}
최대 상대 습도 ^{B)}	90 %
디스플레이 타입	TFT
디스플레이 사이즈	3.5"
디스플레이 해상도	320 × 240
이미지 포맷	.jpg
오디오 포맷	.wav
각 메모리 프로세스당 저장된 요소	열 이미지 1개(스크린샷), 온도값이 포함된 광학 실사 이미지 1개(메타 데이터), 필요 시 음성 메모 1개
내부 화상 메모리의 이미지 개수	600
내부 화상 메모리 내 각 10 초짜리 음성 메모가 포함된 이미지의 개수	350
통합형 광학 카메라의 해상도	640 × 480 px
충전용 배터리(리튬 이온)	10.8 V/12 V
배터리(리튬 이온) 작동 시간 ^{F)(G)}	6 h
USB 연결부	2.0

열화상 카메라	GTC 600 C
시스템 시간 전원 공급	CR2032 (3 V 리튬 이온 배터리) ^{H)}
무선 연결	WLAN
WLAN 최대 송신 출력	< 20 mW
WLAN 작동 주파수 영역	2402–2480 MHz
EPTA-Procedure 01:2014에 따른 중량	0.64–0.75 kg ^{F)}
치수(길이 × 폭 × 높이)	115 × 102 × 231 mm
보호 등급(배터리 제외, 세워진 상태)	IP54
허용되는 주변 온도	
- 충전 시 권장되는 주변 온도	0 ... +35 °C
- 작동 온도	-10 ... +45 °C
- 배터리가 포함된 상태에서 보관 시	-20 ... +50 °C
- 배터리가 미포함된 상태에서 보관 시	-20 ... +70 °C
권장 배터리	GBA 10,8 V GBA 12 V
권장하는 충전기	GAL 12... GAX 18...

A) 규격 VDI 5585(평균값)에 따라

B) 규격 VDI 5585에 따라

C) 주변 온도 20–23 °C, 방사를 > 0.999, 측정 간격: 0.3 m, 작동 시간: > 5 min, 구경 60 mm일 때

D) 사용에 따른 편차 포함(예: 반사, 간격, 주변 온도)

E) 비전도성 오염만 발생하지만, 가끔씩 이슬이 맺히면 임시로 전도성이 생기기도 합니다.

F) 사용하는 배터리에 따라 상이

G) 주변 온도 **20–30 °C**

H) 동전형 배터리 교체는 보쉬 또는 보쉬 전문공구의 공식 고객 서비스 센터에서 진행해야 합니다.

기계 사양은 함께 공급되는 배터리를 사용한 경우입니다.

측정공구를 확실하게 구분할 수 있도록 타입 표시판에 일련 번호 (2) 가 적혀 있습니다.

조립

배터리 충전하기(그림 A 참조)

- ▶ 기술자료에 기재되어 있는 충전기만 사용하십시오. 측정공구에 사용된 리튬이온 배터리에는 이 충전기만 사용할 수 있습니다.

지침: 측정공구에 적합하지 않은 배터리를 사용하면 측정공구에 기능 장애가 생겨 기기가 손상될 수 있습니다.

지침: 배터리는 일부 충전되어 공급됩니다. 배터리의 성능을 완전하게 보장하기 위해서는 처음 사용하기 전에 배터리를 완전히 충전하십시오.

리튬이온 배터리는 항상 충전할 수 있으며, 이로 인해 수명이 단축되지 않습니다. 충전을 하다 중간에 중지해도 배터리가 손상되지 않습니다.

충전된 배터리 (19) 를 배터리 슬롯 (17) 에 삽입하려면, 배터리가 맞물려 끼워지는 느낌이 들고 측정공구의 손잡이에 나란히 위치할 때까지 밀어 넣으십시오.

배터리 (19) 를 분리하려면, 잠금해제 버튼 (18) 을 누르고 배터리를 배터리 슬롯 (17) 에서 빼내십시오. 무리하게 힘을 가하지 마십시오.

작동

- ▶ 측정공구가 물에 젖거나 직사 광선에 노출되지 않도록 하십시오.
- ▶ 극한의 온도 또는 온도 변화가 심한 환경에 측정공구를 노출시키지 마십시오. 예를 들어 장시간 차량 안에 측정공구를 두지 마십시오. 온도 변화가 심한 경우 측정공구를 작동시키기 전에 먼저 온도에 적응할 수 있게 하십시오. 극한 온도에서나 온도 변화가 심한 환경에서 사용하면 측정공구의 정확도가 떨어질 수 있습니다.
- ▶ 측정공구가 환경에 제대로 적응되었는지 확인하십시오. 온도 차이가 심한 경우, 적응 시간은 최대 60 분까지 소요될 수 있습니다. 온도가 낮은 차량에 측정공구를 보관했다가 온도가 높은 건물에서 측정하는 경우가 이에 해당될 수 있습니다.
- ▶ 측정공구가 외부와 세계 부딪히거나 떨어지지 않도록 주의하십시오. 외부로부터 강한 충격을 받았거나, 기능적인 측면에 이상이 발생했다면 Bosch 공식 고객 서비스센터에 측정공구의 점검을 의뢰하는 것이 좋습니다.

기계 사용

전원 켜기/끄기

측정하려면 보호캡 (1) 을 펼치십시오. **작업하는 동안 적외선 센서가 닫혀 있거나 가려져 있지 않도록 유의하십시오.**

측정공구의 전원을 켜려면 전원 버튼 (9) 을 누르십시오. 디스플레이 (15) 에 시작 단계가 나타납니다. 시작 단계가 끝나면 곧바로 측정이 시작되며 전원이 꺼질 때까지 측정이 계속 진행됩니다.

지침: 센서 온도와 주변 온도 사이의 조정이 이뤄지지 않았기 때문에 처음 몇 분간은 여러 번 측정공구의 자체적인 조정이 진행될 수 있습니다. 센서 재조정을 이루어지면 측정 결과가 정확해집니다. 이 시간 동안 온도 표시기는 ~로 표시될 수 있습니다. 센서 조정 중에는 열 이미지가 정지 상태에 있습니다. 주변 온도 변화가 심할수록 이러한 현상이 더욱 강해집니다. 따라서 안정적인 온도를 유지할 수 있도록 가능하면 측정 시작 몇 분 전에 미리 측정공구를 켜십시오.

측정공구의 전원을 끄려면 전원 버튼 (9) 을 다시 누르십시오. 측정공구의 모든 설정이 저장되고 전원이 꺼집니다. 측정공구를 안전하게 운반하려면, 보호캡 (1) 을 닫으십시오.

메인 메뉴에서 측정공구의 자동 꺼짐 및 그 시간 간격을 선택할 수 있습니다 (참조 „시작 메뉴“, 페이지 39).

배터리 또는 측정공구가 제품 사양에 나온 작동 온도를 벗어날 경우, 짧은 경고 (참조 „고장 - 원인 및 대책“, 페이지 41) 후에 측정공구가 자동으로 꺼지게 됩니다. 측정공구의 열이 식으면 그때 다시 전원을 켜십시오.

측정 준비

표면 온도 측정을 위한 방사를 설정

측정 객체의 방사는 온도와 그 표면의 구조에 따라 달라집니다. 측정 객체가 방출하는 적외선 열방출을 이상적인 열방출 물체 (흑체, 방사율 $\epsilon = 1$)와 비교해서 0부터 1까지의 값으로 나타내는 것입니다.

표면 온도를 결정하기 위해, 목표 대상이 발산하는 자연 적외선 열방출이 비접촉 방식으로 측정됩니다. 올바른 측정을 위해서는 **측정하기 전에 항상** 측정공구에 설정되어 있는 방사를 점검하고 경우에 따라서는 측정 객체에 맞춰 조정하십시오.

측정공구에 사전 설정되어 있는 방사는 기준값입니다.

사전 설정되어 있는 방사를 중 하나를 선택하거나 정확한 숫자값을 입력할 수 있습니다. <측정> → <방사율> 메뉴를 통해 원하는 방사를 설정하십시오 (참조 „시작 메뉴“, 페이지 39).

▶ 온도는 설정된 방사율과 객체의 방사율이 일치할 때만 정확하게 표시됩니다.

방사율이 낮을수록 반사 온도가 측정 결과에 미치는 영향이 커집니다. 따라서 방사율을 변경할 때는 반드시 반사 온도를 조정하십시오. <측정> → <반사

온도> 메뉴를 통해 원하는 반사 온도를 설정하십시오 (참조 „시작 메뉴“, 페이지 39).

측정공구에 의해 제시되는 가상의 온도 차이는 상이한 온도 및/또는 상이한 방사를 때문일 수 있습니다. 방사율 차이가 너무 크면 표시되는 온도 차이가 실제값과 확연히 다를 수 있습니다.

측정 영역 내에 소재나 구조가 다른 측정 객체가 여러 개 있을 경우에는 설정된 방사율에 맞는 객체를만 정확하게 온도값이 표시됩니다. (다른 방사율을 적용하는) 다른 모든 객체들은 표시되는 색상 차이를 온도 관계의 기준으로 삼을 수 있습니다.

측정 조건에 관한 지침

강하게 반사되는 표면 또는 광택 표면 (예: 광택 타일 또는 광택 금속)은 표시 결과를 심하게 왜곡하거나 또는 그에 부정적인 영향을 줄 수 있습니다. 경우에 따라 측정표면에 열전도가 잘 되는 어두운 색의 무광택 접착 테이프를 부착하여 주십시오. 테이프가 표면 온도에 적응할 시간을 줍니다.

반사 표면에서는 적합한 측정 각도에 유의하여 다른 물체에서 반사된 열방출이 결과에 영향을 주지 않도록 하십시오. 예컨대 수직 측정을 진행하는 경우 작업자 자신의 체온 반사로 인해 처음부터 측정에 부정적인 영향을 줄 수 있습니다. 평평한 표면에서는 측정 표면의 원래 온도(방사값 및 표면의 실제값)에 해당되지 않는 작업자의 신체 윤곽 및 체온(반사된 값)이 표시될 수도 있습니다.

투명한 소재 (예: 유리 또는 투명 플라스틱)를 통과하는 측정은 원칙적으로 불가능합니다.

측정 조건이 안정적이고 우수할수록, 정확하고 신뢰할 만한 결과를 얻을 수 있습니다. 이때 주변의 심한 온도 변화 외에 측정 객체의 심한 온도 변화 역시 정확도에 부정적인 영향을 줄 수 있습니다.

적외선 온도 측정은 스모그, 증기 및 높은 습도 또는 먼지의 영향을 받습니다.

측정 정확도를 높이기 위한 지침:

- 작업자와 측정 표면 사이의 방해 요소들을 최소화하기 위해서 최대한 객체 가까이 접근하십시오.
- 특히 공기가 오염되거나 증기가 많은 경우, 측정 전에 실내를 환기시켜 주십시오. 환기 후 잠시 평상시 온도를 되찾을 때까지 온도 적응시간을 두십시오.

눈금자에 의한 온도 분류

디스플레이 오른쪽에는 눈금자 (h) 가 표시됩니다. 상단 값 및 하단 값들은 열 이미지에 감지되는 최고 온도 (g) 및 최저 온도 (i) 를 가리킵니다. 전체 픽셀의 99.9 % 가 눈금자로 구분됩니다. 이미지 내에서 온도값에 대한 색상 분포는 대칭으로 이루어집니다(직선).

이에 따라 상이한 색상을 이용해 두 경계 값 사이의 온도를 분류할 수 있습니다. 이때 정확하게 최대값과 최소값 사이에 위치하는 온도는 예컨대 눈금자의 중앙 색상 영역에 배치됩니다.



구체적인 범위의 온도를 측정할 때는 원하는 지점 또는 영역 위에 온도 표시기 (I) 십자선이 위치할 때까지 측정공구를 이동시키십시오. 자동 설정에서는 눈금자의 색상 스펙트럼이 항상 전체 측정 영역의 최고 온도와 최저 온도 내에서 직선으로 (= 대칭으로) 분포됩니다.

측정공구는 측정 영역 내에서 측정되는 모든 온도를 상대적으로 비례해서 표시합니다. 예컨대 색상 표시 영역에서 열이 색상표의 청색으로 표시된다면, 현재 측정 영역에서는 청색 영역이 상대적으로 저온의 측정값에 속한다는 의미입니다. 그러나 상황에 따라 이 영역은 부상이 발생할 수도 있는 영역입니다. 따라서 항상 눈금자 또는 십자선에 직접 표시되는 온도에 유의하십시오.

기능

색상 표시 조정

측정 상황에 따라 여러 가지 유형의 색상표를 사용하면 열 이미지 분석이 쉬워지고 객체 또는 상황을 디스플레이에 더욱 확실하게 반영할 수 있습니다. 측정된 온도는 아무런 영향을 받지 않습니다. 온도 값 표시만 바뀝니다.

색상표를 변경하려면 측정 모드 상태에서 오른쪽 화살표 버튼 (8) 또는 왼쪽 화살표 버튼 (12) 을 누르십시오.

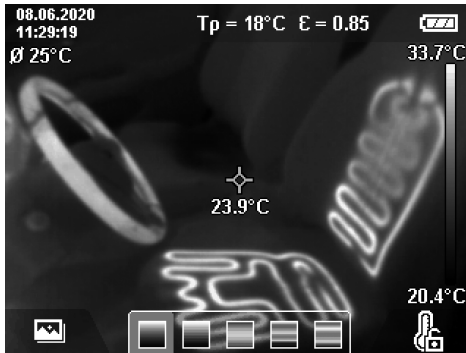

열 이미지 및 실사 이미지의 중복

온도 영역이 조정되어 있는 상태에서 추가로 광학 실사 이미지를 켜서 정렬 (= 표시되는 열 이미지의 공간 배치)을 더 좋게 구성할 수 있습니다.

지침: 실사 이미지 및 열 이미지 중복은 0.55 m 간격에서 정확하게 중복됩니다. 측정 객체까지의 간격 일탈 시에는 원칙적으로 실사 이미지와 열 이미지 간에 불일치가 생깁니다. 이런 불일치는 GTC 전송 소프트웨어로 보정할 수 있습니다.

본 측정공구에 제공되는 선택 기능은 다음과 같습니다.

- **100 % 적외선 이미지**
열 이미지만 표시됩니다.
 - **화면 속 화면**
표시되는 열 이미지가 축소되고 주변 영역이 실사 이미지로 표시됩니다. 이 설정은 측정 영역의 공간 배치를 더 좋게 변경합니다.
 - **투명 기능**
표시되는 열 이미지가 실사 이미지 위에 투명 상태로 놓입니다. 객체 확인이 보다 쉬워집니다.
- 위쪽 화살표 버튼 (5) 또는 아래쪽 화살표 버튼 (10) 을 눌러 설정을 선택할 수 있습니다.



눈금자 고정

열 이미지의 색상 분포 조정은 오른쪽 기능 버튼 (7) 을 눌러 고정할 수 있습니다. 이렇게 하면 (예를 들어 여러 공간의 열교 점검 시) 상이한 온도 조건에서 촬영한 열 이미지들을 비교하거나 열 이미지에서 극도로 차갑거나 뜨거운 개체를 숨길 수 있습니다(예: 열교 탐색 시 뜨거운 개체로 탐지되는 가열체).

눈금자를 다시 자동으로 전환하려면 오른쪽 기능 버튼 (7) 을 새로 누릅니다. 그러면 온도가 다시 동적으로 움직이면서 측정된 최소값과 최대값에 맞추어 조정됩니다.

측정 기능

표시기에 도움이 되는 다른 기능들을 불러올 때는 버튼 **Func** (6) 을 누르십시오. 왼쪽 화살표 버튼 (12) 및 오른쪽 화살표 버튼 (8) 을 눌러서 표시된 선택 기능들을 탐색하여 기능을 선택합니다. 기능을 선택하고 버튼 **Func** (6) 을 다시 누르십시오.

제공되는 측정 기능은 다음과 같습니다.

- <자동>
열 이미지의 색상 분포가 자동으로 이뤄집니다.
- <열 탐색>
본 측정 기능은 측정 영역 내에서 비교적 따뜻한 온도만 열 이미지로 표시됩니다. 이런 따뜻한 온도 외의 영역들은 실사 이미지 형태로 회색 톤으로 표시됩니다. 회색 톤 표시는 유색 개체가 온도와 잘못 연결되는 일이 없도록 합니다(예: 과열된 구성 요소를 탐색할 때 전장의 적색 케이블). 위쪽 화살표 버튼 (5) 및 아래쪽 화살표 버튼 (10)을 눌러 눈금자를 조정하십시오. 그러면 표시되는 온도 영역이 열 이미지 형태로 확대 또는 축소되어 표시됩니다. 측정공구는 계속해서 최저 온도 및 최고 온도를 함께 측정하여 이를 눈금자 (h) 끝부분에 표시합니다.
- <냉열 탐색>
본 측정 기능은 측정 영역 내에서 비교적 차가운 온도만 열 이미지로 표시됩니다. 유색 개체가 온도와 잘못 연결되는 일이 없도록(예: 결함이 있는 방열재를 탐색할 때 청색 창틀) 이런 차가운 온도 외의 영역들은 실사 이미지 형태로 회색 톤으로 표시됩니다. 위쪽 화살표 버튼 (5) 및 아래쪽 화살표 버튼 (10)을 눌러 눈금자를 조정하십시오. 그러면 표시되는 온도 영역이 열 이미지 형태로 확대 또는 축소되어 표시됩니다. 측정공구는 계속해서 최저 온도 및 최고 온도를 함께 측정하여 이를 눈금자 (h) 끝부분에 표시합니다.
- <수동>
열 이미지 내에 편차가 심한 온도들이 측정되면(예: 열교 조사 시 뜨거운 개체로서 가열체) 사용 가능한 색상들이 최대 온도와 최소 온도 사이 영역의 수많은 온도값에 분포됩니다. 그러면 미세한 온도 차이를 더이상 상세히 표시할 수 없습니다. 조사 대상 온도 영역을 상세히 표시하려면 다음과 같이 하십시오. <수동> 모드로 변경하면 최고 온도 및 최저 온도를 직접 조절할 수 있습니다. 이렇게 하면 미세한 차이를 확인하고 싶은 주요 온도 영역을 정할 수 있습니다. <눈금 리셋> 설정은 눈금자가 적외선 센서 시야에서 측정되는 값에 맞춰 다시금 자동 조정됩니다.

시작 메뉴

메인 메뉴로 전환하려면 먼저 버튼 **Func (6)**을 눌러 측정 기능을 불러오시오. 그 다음 오른쪽 기능 버튼 (7)을 누르십시오.

- <측정>
 - <방사율> (d)
자주 측정하는 소재의 경우 저장된 방사율을 선택할 수 있습니다. 간편 검색을 위해 방사율 목록과 그룹 만들기로 값을 관리할 수 있습니다. <소재> 메뉴 항목에서 먼저 적합한 카테고리 외와 적합한 소재를 선택합니다. 해당 방사율이 아래에 표시됩니다. 측정 객체의 정확한 방사율을 알고 있을 경우, <방사율> 메뉴 항목에서 숫자값으로도 설정할 수 있습니다. 동일한 소재들을 자주 측정하는 경우, 5개의

방사율을 즐겨찾기로 저장한 뒤 윗줄(1부터 5까지)에서 빠르게 불러올 수 있습니다.

- <반사 온도> (c)
이 매개 변수를 설정하면 특히 방사율이 낮은 (= 반사도가 높은) 소재에서 측정 결과가 개선됩니다. 대부분의 경우 (특히 실내에서) 반사 온도는 주변 온도와 일치합니다. 측정 객체 주변에 방사율이 높은 개체가 있고 온도 차이가 커서 측정에 영향을 줄 수 있는 경우, 이 값을 조정해야 합니다.
- <디스플레이>
 - <중간 지점> (l)
점은 열 이미지의 중앙에 표시되고 측정되는 온도값을 이 지점에 표시합니다.
 - <열점> (k): <커짐>/<꺼짐>
최고 열점 (= 측정 픽셀)은 열 이미지 내에서 적색 십자선 마크로 표시됩니다. 이를 통해 임계 지점(예: 전장 내 느슨해진 접점 단자)을 더욱 쉽게 찾을 수 있습니다. 최대한 정확하게 측정할 수 있도록 측정 객체가 디스플레이 (85 × 64 px) 중앙에 오도록 하십시오. 이런 방법으로 측정 객체의 해당 온도값이 표시됩니다.
 - <냉점> (m): <커짐>/<꺼짐>
최저 열점 (= 측정 픽셀)은 열 이미지 내에서 청색 십자선 마크로 표시됩니다. 이를 통해 임계 지점(예: 창문의 밀폐되지 않은 지점)을 더욱 쉽게 찾을 수 있습니다. 최대한 정확하게 측정할 수 있도록 측정 객체가 디스플레이 (85 × 64 px) 중앙에 오도록 하십시오.
 - <컬러 범위> (h): <커짐>/<꺼짐>
 - <평균온도 > (b): <커짐>/<꺼짐>
평균 온도 (b)는 열 이미지의 상단 왼쪽에 표시됩니다(열 이미지 내 모든 측정값의 평균적인 온도). 이를 통해서 쉽게 반사 온도를 확인할 수 있습니다.
- <WiFi> (e): <커짐>/<꺼짐>
(참조 „데이터 전송“, 페이지 40)
- <제품>
 - <언어>
본 메뉴 항목에서는 표시기에 사용되는 언어를 선택할 수 있습니다.
 - <시간 & 날짜> (a)
측정공구의 날짜 및 시간을 변경하려면 하위 메뉴 <시간 & 날짜>를 불러오십시오. 본 하위 메뉴에서는 날짜 및 시간을 설정할 수 있고 각각의 형식도 변경할 수 있습니다. 하위 메뉴 <시간> 및 <날짜>에서 벗어나려면, 오른쪽 기능 버튼 (7)을 눌러 설정 내역을 저장하거나 왼쪽 기능 버튼 (14)을 눌러 변경을 취소하십시오.
 - <자동꺼짐>
본 메뉴 항목에서는 버튼 누름이 없을 경우 측정공구가 자동으로 꺼지게 되는 시간 간격을 선택할 수 있습니다. <끄지않기> 설정을 선택해 자동 꺼짐을 비활성화할 수도 있습니다.
 - <WiFi 채널>
본 메뉴 항목에서는 다른 Wi-Fi® 경로를 설정할 수 있습니다.

▪ <높은 오디오 품질>

본 메뉴 항목에서는 음성 메모로 기록되는 오디오 파일의 음질을 조절할 수 있습니다. 음질이 높을 경우 더 많은 저장 공간이 필요하다는 점에 유의하십시오.

▪ <제품정보>

본 메뉴 항목에서는 측정공구에 관한 정보를 불러올 수 있습니다. 측정공구의 일련 번호와 설치된 소프트웨어 버전을 확인할 수 있습니다.

▪ <초기 설정>

본 메뉴 항목에서는 측정공구를 초기 설정으로 리셋하고, 모든 데이터를 영구적으로 삭제할 수 있습니다. 이 경우 상황에 따라 수 분이 소요될 수 있습니다. 하위 메뉴로 이동하려면, <더보기>의 오른쪽 화살표 버튼 (8)을 누르십시오. 오른쪽 기능 버튼 (7)을 눌러 모든 데이터를 삭제하거나, 왼쪽 기능 버튼 (14)을 눌러 작업을 중단하십시오.

모든 메뉴에서 벗어나 기본 표시 화면으로 되돌아가려면, 측정 버튼 (20)을 눌러도 됩니다.

측정 결과의 문서화 작업

측정 결과 저장

전원이 켜지면 곧바로 측정이 시작되며 전원이 꺼질 때까지 계속 진행됩니다.

이미지를 저장하려면 원하는 측정 객체로 카메라를 정렬한 후 저장 버튼 (11)을 누르십시오. 이미지는 측정공구의 내부 메모리에 보관됩니다. 다른 방법으로 측정 버튼 (20) (일시정지)을 눌러도 됩니다. 측정이 정지되고 디스플레이에 표시됩니다. 이렇게 하면 이미지 상세 확인 및 추가 변경이 더욱 쉬워집니다 (예: 색상표). 정지된 이미지를 저장하지 않으려면, 측정 버튼 (20)을 눌러 측정 모드를 다시 시작하십시오. 측정공구 내부 메모리에 이미지를 저장하려면, 저장 버튼 (11)을 누르십시오.

음성 메모 녹음

저장된 열 이미지와 관련된 환경 조건 또는 추가 정보를 기록하기 위해 음성 메모를 녹음할 수 있습니다. 음성 메모는 열 이미지 및 광학 이미지에 추가로 저장되며 나중에 전송할 수 있습니다.

안전한 문서화 작업을 위해 음성 메모 녹음이 권장됩니다.

음성 메모 녹음은 갤러리에서 이뤄집니다. 진행 방법은 다음과 같습니다.

- 왼쪽 기능 버튼 (14)을 눌러 갤러리로 이동하십시오.
- 버튼 **Func (6)**을 누르십시오. 녹음이 시작됩니다. 모든 주요 정보들을 녹음하십시오.
- 녹음을 **종료하려면**, 버튼 **Func (6)** 또는 오른쪽 기능 버튼 (7)을 한 번 더 누르십시오.
- 녹음을 **중단하려면**, 왼쪽 기능 버튼 (14)을 누르십시오. 녹음 후 음성 메모를 들을 수 있습니다.
- 녹음을 **들으려면**, 버튼 **Func (6)**을 다시 누르십시오. 녹음이 재생됩니다.
 - 재생을 **일시정지하려면**, 오른쪽 기능 버튼 (7)을 누르십시오. 일시정지된 녹음을 계속 재생

하려면, 다시 오른쪽 기능 버튼 (7)을 누르십시오.

- 재생을 **멈추려면**, 왼쪽 기능 버튼 (14)을 누르십시오.

새 음성 메모를 녹음하려면, 이전 음성 메모를 삭제한 다음 새 녹음을 시작합니다.

녹음 시 유의해야 할 사항은 다음과 같습니다.

- 마이크 (13)는 자판 뒤쪽 마이크 기호 옆에 있습니다. 마이크 방향으로 말하십시오.
- 녹음은 최대 30 초까지 가능합니다.

저장된 이미지 불러오기

저장된 열 이미지를 불러오는 방법은 다음과 같습니다.

- 왼쪽 기능 버튼 (14)을 누르십시오. 마지막으로 저장된 사진이 디스플레이에 나타납니다.
- 저장된 열 이미지 사이로 이동하려면, 오른쪽 화살표 버튼 (8) 또는 왼쪽 화살표 버튼 (12)을 누르십시오.

열 이미지에 추가해서 광학 이미지도 저장되어 있습니다. 광학 이미지를 불러오려면, 아래쪽 화살표 버튼 (10)을 누르십시오.

위쪽 화살표 버튼 (5)을 누르면 촬영된 열 이미지를 전체 화면으로도 표시할 수 있습니다. 전체 화면에서는 제목표시줄 표시기가 3 초 후에 사라지고 열 이미지의 모든 정보를 볼 수 있습니다.

위쪽 화살표 버튼 (5) 및 아래쪽 화살표 버튼 (10)을 사용해 화면을 변경할 수 있습니다.

저장된 이미지 삭제 및 음성 메모

각각의 열 이미지 또는 모든 열 이미지를 삭제하려면, 다음과 같이 갤러리 화면으로 이동하십시오.

- 휴지통 기호 아래 오른쪽 기능 버튼 (7)을 누르십시오. 하위 메뉴가 열립니다. 여기에서 이 이미지만 삭제할 것인지 또는 관련된 음성 메모(녹음을 한 경우)를 삭제할 것인지 선택할 수 있습니다. 해당 이미지만 삭제하거나 또는 음성 메모를 삭제하고 싶을 때는 버튼 **Func (6)**을 눌러 확인하십시오.
- 모든 이미지를 삭제하고 싶을 때는 버튼 **Func (6)** 또는 오른쪽 기능 버튼 (7)을 누른 후, 추가로 오른쪽 기능 버튼 (7)을 눌러 확인하거나 또는 왼쪽 기능 버튼 (14)을 눌러 삭제 과정을 중단하십시오.

데이터 파편이 메모리에 남아 있어서 재건이 가능할 수도 있습니다. 최종 삭제는 메인 메뉴 <제품> → <초기 설정>에서 선택하십시오.

데이터 전송

USB 포트를 통한 데이터 전송

USB Type-C® 포트 (3)의 커버를 여십시오. 측정공구의 USB Type-C® 포트 (4)를 함께 제공되는 USB Type-C® 케이블 (23)을 사용해 컴퓨터와 연결하십시오.

이제 전원 버튼 (9)을 눌러 측정공구를 켜십시오. 컴퓨터에서 데이터 브라우저를 열고 **GTC 600 C** 드라이브를 선택하십시오. 저장된 데이터는 측정공구

의 내부 메모리에서 복사해 컴퓨터로 옮기거나 삭제할 수 있습니다.

원하는 작업이 종료되면 컴퓨터에서 드라이브를 정상적으로 분리한 뒤 전원 버튼 (9) 을 눌러 측정공구를 끄십시오.

주의: 반드시 운영 시스템에서 먼저 드라이브 연결을 끊어야 합니다(드라이브 분리). 그렇지 않은 경우 측정공구의 내부 메모리가 손상될 수 있습니다. 측정 작동 **도중에는** USB Type-C® 케이블을 분리하고 커버 (3) 를 닫아 두십시오.

하우징 안으로 먼지나 물기가 들어가지 않도록 USB 포트 커버를 항상 닫아 두십시오.

지침: 측정공구는 USB를 통해 컴퓨터에만 연결하십시오. 다른 장치에 연결할 경우 측정공구가 손상될 수 있습니다.

지침: USB Type-C® 단자는 데이터 전송에만 사용됩니다. 배터리 및 충전용 배터리를 충전하는데 사용할 수 없습니다.

열 이미지 보충 작업

저장된 열화상 이미지는 컴퓨터 Windows 운영 시스템에서 추가 작업을 할 수 있습니다. 이와 관련해 측정공구 제품 사이트

www.bosch-professional.com에서 GTC 전송 소프트웨어를 다운로드 받으십시오.

WLAN을 통한 데이터 전송

측정공구에는 Wi-Fi®-인터페이스가 탑재되어 있으며, 측정공구에 저장된 이미지를 모바일 단말기로 무선 전송할 수 있습니다.

이 기능을 사용할 수 있도록 전문적인 보쉬 애플리케이션(앱)이 제공됩니다. 단말기에 따라 해당 스토어에서 다운로드할 수 있습니다.











보쉬 애플리케이션을 통해 (이미지의 무선 데이터 전송 외에) 확장된 기능 서비스를 사용하고, 측정 후 추가 작업들을 간편하게 진행하며, 측정 데이터를 (이메일 등으로) 전송할 수 있습니다. Wi-Fi®-연결에 필요한 시스템 관련 정보는 보쉬 인터넷 사이트 www.bosch-professional.com 에서 확인할 수 있습니다.



측정공구에서 Wi-Fi®-연결을 활성화/비활성화시키려면, 메인 메뉴를 불러온 후 <Wi-Fi> 기능을 선택할 수 있는 버튼을 탐색하여 연결을 활성화/비활성화하십시오. Wi-Fi®가 활성화되면 디스플레이에 표시기 (e) 가 나타납니다. 모바일 단말기에 있는 Wi-Fi®-인터페이스가 활성화되었는지 확인하십시오.

보쉬 애플리케이션을 시작하면 (Wi-Fi®-모듈이 활성화된 상태에서) 모바일 단말기와 측정공구가 연결됩니다. 이와 관련하여 애플리케이션(앱)의 설명에 따르십시오.

고장 - 원인 및 대책

장애가 발생하면 측정공구는 재시동 후 다시 사용할 수 있게 됩니다. 그 외 고장 메시지가 계속되는 경우 다음 내용을 확인하십시오.

고장	원인	해결 방법
 측정공구가 켜지지 않습니다.	배터리가 비어 있음	배터리를 충전하십시오.
 배터리 온도가 너무 높거나 낮음	배터리 온도가 너무 높거나 낮음	배터리의 열을 식히거나 배터리를 교체하십시오.
 측정공구 온도가 너무 높거나 낮음	측정공구 온도가 너무 높거나 낮음	측정공구의 열을 식히십시오.
 화상 메모리 부족	화상 메모리 부족	필요한 경우 이미지를 다른 저장 매체(예: 컴퓨터)로 옮기십시오. 그리고 나서 내부 메모리의 이미지를 삭제하십시오.
 화상 메모리 결함	화상 메모리 결함	모든 이미지를 삭제하고 내부 메모리를 포맷하십시오. 문제가 계속될 경우 측정공구를 보쉬의 공인 서비스 센터에 맡기십시오.
 Wi-Fi® 연결 시 데이터 전송이 느림	Wi-Fi® 연결 시 데이터 전송이 느림	(메인 메뉴 <제품> → <Wi-Fi 채널> 에서) Wi-Fi® 경로를 변경하십시오.
 컴퓨터가 측정공구를 인식하지 못합니다.	컴퓨터가 측정공구를 인식하지 못합니다.	컴퓨터 드라이버의 업데이트를 확인하십시오. 경우에 따라 컴퓨터 운영 시스템 업데이트가 필요합니다.
 측정공구와 컴퓨터가 연결되지 않습니다.	USB 연결부 또는 USB 케이블 결함	측정공구가 다른 컴퓨터와 연결되는지 확인하십시오. 연결되지 않는다면 측정공구를 보쉬의 공인 서비스 센터에 맡기십시오.

고장	원인	해결 방법
	동전형 배터리가 비어있음	보쉬 또는 보쉬 전동공구의 공식 고객 서비스 센터에서 동전형 배터리 교체를 진행하십시오.
	측정공구 결함	측정공구를 보쉬의 공인 서비스 센터에 맡기십시오.

개념 설명

보다 자세한 정보는 www.bosch-professional.com 에서 찾으실 수 있습니다.

적외선 열방출

적외선 열방출은 켈빈 온도 0 (-273 °C)를 초과하는 모든 물체에서 나오는 전자기파입니다. 방출량은 물체의 온도 및 방사율에 따라 다릅니다.

방사율

측정 객체의 방사율은 소재와 그 표면의 구조에 따라 달라집니다. 측정 객체가 방출하는 적외선 열방출을 이상적인 열방출 물체 (흑체, 방사율 $\epsilon = 1$)와 비교해서 0부터 1까지의 값으로 나타내는 것입니다.

열교

열교란 건물 외벽에서 설계상 부분적으로 열 손실이 증가된 지점을 말합니다.

열교는 곰팡이 위험을 높일 수 있습니다.

반사 온도 / 측정 객체의 반사도

반사 온도는 측정 객체 자체에서 나오지 않는 열방출입니다. 구조와 소재에 따라서 주변 방출이 측정 객체에서 반사되어 원래의 온도 결과에 영향을 줍니다.

객체 간격

측정 객체와 측정공구 사이의 간격은 픽셀당 감지되는 면적 크기에 영향을 줍니다. 객체 간격이 커지면 감지할 수 있는 객체의 크기가 커집니다.

거리 (m)	적외선 픽셀 크기 (mm)	적외선 영역 너비 × 높이 (m)
0.3	1	0.25 × 0.19
0.55	2	~ 0.46 × 0.35
1	3	~ 0.83 × 0.63
2	6	~ 1.66 × 1.26
5	16	~ 4.14 × 3.15

보수 정비 및 서비스

보수 정비 및 유지

측정공구는 반드시 원래의 포장재와 같은 적합한 용기 안에 넣어서 보관 및 운반하십시오.

항상 측정공구를 깨끗이 유지하십시오. 오염물이 묻은 적외선 센서 (21) 는 측정 정확도에 문제가 생길 수 있습니다.

청소할 때 액체가 측정공구 안으로 들어가지 않도록 하십시오.

뽀족한 물체로 적외선 센서 (21), 카메라 (22), 스피커 (16) 또는 마이크 (13) 의 오염물을 제거하려 하면 안 됩니다. 적외선 센서 및 카메라를 닦지 마십시오 (긁힐 위험).

측정공구를 새로 보정할 때는 보쉬의 공인 서비스 센터에 맡기십시오.

수리하는 경우 측정공구를 원래의 포장재 안에 넣어서 보내주십시오.

측정공구에는 사용자가 유지보수할 수 있는 부품이 없습니다. 하우징 커버를 열면서 측정공구가 파손될 수 있습니다.

내장된 동전형 배터리 교체하기

동전형 배터리 교체는 보쉬 또는 보쉬 전동공구의 공식 고객 서비스 센터에서 진행해야 합니다.

▶ 주의: 동전형 배터리는 항상 동일한 타입의 동전형 배터리로 교체하십시오. 폭발 위험이 있습니다.

▶ 방전된 수은전지는 규정에 맞게 제거한 후 폐기하십시오. 방전된 수은전지는 누수될 수 있으며 이는 인체나 제품에 해를 끼칠 수 있습니다.

AS 센터 및 사용 문의

AS 센터에서는 귀하 제품의 수리 및 보수정비, 그리고 부품에 관한 문의를 받고 있습니다. 대체 부품에 관한 분해 조립도 및 정보는 인터넷에서도 찾아 볼 수 있습니다 - www.bosch-pt.com

보쉬 사용 문의 팀에서는 보쉬의 제품 및 해당 액세서리에 관한 질문에 기꺼이 답변 드릴 것입니다. 문의나 대체 부품 주문 시에는 반드시 제품 내임 플레이트에 있는 10자리의 부품번호를 알려 주십시오.

콜센터
080-955-0909

다른 AS 센터 주소는 아래 사이트에서 확인할 수 있습니다:

www.bosch-pt.com/serviceaddresses

운반

권장하는 리튬이온 배터리는 위험물 관련 규정을 따릅니다. 배터리는 별도의 요구 사항 없이 사용자가 직접 도로 상에서 운반할 수 있습니다.

제3자를 통해 운반할 경우(항공 운송이나 운송 회사 등) 포장과 표기에 관한 특별한 요구 사항을 준수해야 합니다. 이 경우 발송 준비를 위해 위험물 전문가와 상담해야 합니다.

표면이 손상되지 않은 배터리만 사용하십시오. 배터리의 접촉 단자면을 덮어 붙인 상태로 내부에서 움직이지 않도록 배터리를 포장하십시오. 또한 이와 관련한 국내 규정을 준수하십시오.

처리



측정공구, 충전용 배터리/배터리, 액세서리 및 포장은 친환경적으로 재활용됩니다.



측정공구 및 충전용 배터리/배터리를 가정용 쓰레기에 버리지 마십시오!

충전용 배터리/배터리:

리튬이온:

운반 단락에 나와 있는 지침을 참고하십시오 (참조 „운반“, 페이지 42)을 누르십시오.

ไทย

กฎระเบียบเพื่อความปลอดภัย



ต้องอ่านและปฏิบัติตามคำแนะนำทั้งหมด หากไม่ใช้เครื่องมือวัดตามคำแนะนำเหล่านี้ ระบบป้องกันเบ็ดเสร็จในเครื่องมือวัดอาจได้รับผลกระทบ เก็บรักษาคำแนะนำเหล่านี้

สำหรับใช้อ้างอิงในภายหลัง

- ▶ ส่งเครื่องมือวัดให้ช่างผู้เชี่ยวชาญตรวจสอบและใส่อะไหล่เปลี่ยนของแท้เท่านั้น ทั้งนี้เพื่อให้มั่นใจได้ว่าจะสามารถใช้งานเครื่องมือวัดได้อย่างปลอดภัยเสมอ
- ▶ อย่าใช้เครื่องมือวัดในสภาพแวดล้อมที่เสี่ยงต่อการระเบิด ซึ่งเป็นที่ที่มีของเหลว แก๊ส หรือฝุ่นที่ติดไฟได้ในเครื่องมือวัดสามารถเกิดประกายไฟซึ่งอาจจุดฝุ่นละอองหรือไอระเหยให้ติดไฟได้
- ▶ อย่าเปิดแบตเตอรี่ อันตรายจากการลัดวงจร
- ▶ เมื่อแบตเตอรี่ชาร์ตและนำไปใช้งานอย่างไม่ถูกต้อง อาจมีไอระเหยออกมาได้ แบตเตอรี่อาจเผาไหม้หรือระเบิดได้ให้สูดอากาศบริสุทธิ์และไปพบแพทย์ในกรณีเจ็บปวด ไอระเหยอาจทำให้ระบมหายใจระคายเคือง
- ▶ หากใช้อย่างไม่ถูกต้องหรือหากแบตเตอรี่ชาร์ตของเหลวไหลออกมาจากแบตเตอรี่ได้ หลีกเลี่ยงการสัมผัสของเหลว ในกรณีสัมผัสโดยไม่ได้ตั้งใจให้ล้างออกด้วยน้ำ หากของเหลวเข้าตา ให้ไปพบแพทย์

ด้วย

ของเหลวที่ไหลออกมาจากแบตเตอรี่อาจทำให้เกิดอาการคันหรือแสบผิวหนังได้

- ▶ **วัตถุที่แหลมคม ต. ย. เช่น ตะปูหรือไขควง หรือแรงกระแทกภายนอก อาจทำให้แบตเตอรี่เสียหายได้** สิ่งเหล่านี้นี้อาจทำให้เกิดการลัดวงจรภายในและแบตเตอรี่ใหม่ มีควัน ระเบิด หรือร้อนเกินไป
- ▶ **นำแบตเตอรี่ที่ไม่ได้ใช้งานออกห่างจากคลิป์หนีบกะดาศ เหยี่ยง กุญแจ ตะปู สกรู หรือวัตถุโลหะขนาดเล็กอื่นๆ ที่สามารถเชื่อมต่อขั้วหนึ่งไปยังอีกขั้วหนึ่งได้** การลัดวงจรของขั้วแบตเตอรี่อาจทำให้เกิดการไหม้หรือไฟลุกได้
- ▶ **ใช้แบตเตอรี่ที่แพ็คเกจเฉพาะ ในผลิตภัณฑ์ของผู้ผลิตเท่านั้น** ในลักษณะนี้ แบตเตอรี่แพ็คเกจได้รับการปกป้องจากการใช้งานเกินกำลังซึ่งเป็นอันตราย
- ▶ **ชาร์จแบตเตอรี่แพ็คเกจด้วยเครื่องชาร์จที่บริษัทผู้ผลิตแนะนำเท่านั้น** เครื่องชาร์จที่เหมาะสมสำหรับชาร์จแบตเตอรี่ประเภทนี้ หากนำไปชาร์จแบตเตอรี่ประเภทอื่น อาจเกิดไฟไหม้ได้



ปกป้องแบตเตอรี่จากความร้อน รวมทั้ง ต. ย.

เช่น จากการถูกแสงแดดส่องต่อเนื่อง จากไฟ



ลิ่งสปริง น้ำ และความชื้น อันตรายจากการระเบิดและการลัดวงจร

- ▶ **ป้องกันเครื่องมือวัดโดยเฉพาะบริเวณเลนส์อินฟราเรด ลำโพง และไมโครโฟนให้พ้นจากความชื้น หิมะ ฝุ่นและสิ่งสกปรก** เลนส์รับอาจเกิดฝ้าหรือสกปรกและผลการวัดอาจผิดเพี้ยนได้ การตั้งค่าอุปกรณ์อย่างไม่ถูกต้องตลอดจนปัจจัยอื่นๆ ที่มีอิทธิพลต่อบรรยากาศอาจทำให้การวัดผิดเพี้ยนได้ วัตถุอาจแสดงอุณหภูมิสูงหรือต่ำเกินไป ซึ่งอาจเป็นอันตรายเมื่อสัมผัส
- ▶ **ความแตกต่างมาก ของอุณหภูมิในสภาพความร้อนอาจทำให้อุณหภูมิสูงถูกแสดงในสิ่งที่เกี่ยวข้องกับอุณหภูมิต่ำ** การสัมผัสกับพื้นผิวดังกล่าวอาจทำให้เกิดการไหม้
- ▶ **ท่านสามารถวัดอุณหภูมิได้อย่างถูกต้องหากค่าสัมประสิทธิ์การแผ่รังสีความร้อนที่ตั้งไว้สอดคล้องกับค่าสัมประสิทธิ์การแผ่รังสีความร้อนของวัตถุ** วัตถุอาจแสดงอุณหภูมิสูงหรือต่ำเกินไป ซึ่งอาจเป็นอันตรายเมื่อสัมผัส
- ▶ **อย่าใช้เครื่องมือวัดไปยังแสงอาทิตย์โดยตรงหรือเลเซอร์ CO₂ ประสิทธิภาพสูง** อาจทำให้เครื่องตรวจจับเสียหายได้
- ▶ **อย่าวางเครื่องมือวัดไว้บนแบตเตอรี่แพ็คเกจ** อาจพลิกคว่ำได้ง่าย อาจก่อให้เกิดการบาดเจ็บ



ต้องกันแม่เหล็กให้ห่างจากวัตถุปลูกถ่ายในร่างกายและอุปกรณ์ทางการแพทย์อื่นๆ เครื่องปรับจังหวะการเต้นของหัวใจด้วยไฟฟ้าหรือมีอินซูลิน ระบบจะสร้างสนามแม่เหล็กซึ่งสามารถทำให้วัตถุปลูกถ่ายในร่างกายและอุปกรณ์ทางการแพทย์อื่นๆ ทำงานบกพร่องได้

- ▶ ต้องกันเครื่องมือวัดให้ห่างจากสื่อข้อมูลที่มีคุณสมบัติเป็นแม่เหล็กและอุปกรณ์ที่ไวต่อแรงดึงดูดแม่เหล็ก แม่เหล็กสามารถทำให้ข้อมูลสูญหายอย่างเรียกกลับไม่ได้
- ▶ เครื่องมือวัดมีอินเทอร์เฟซคลื่นวิทยุสำหรับเชื่อมต่อสื่อสารแบบไร้สายต้องปฏิบัติตามข้อจำกัดการทำงานในพื้นที่ ต. ย. เช่น ในเครื่องบิน หรือโรงพยาบาล



คำเตือน



ตรวจสอบให้แน่ใจว่าได้เก็บถ่านกระดุมให้พ้นมือเด็กแล้ว ถ่านกระดุมอันตราย

- ▶ ห้ามไม่ให้ถ่านกระดุมเข้าไปในช่องเปิดของร่างกาย หากสงสัยว่าได้กลืนถ่านกระดุมหรือถ่านกระดุมถูกใส่เข้าไปในช่องเปิดของร่างกาย ให้รีบไปพบแพทย์ทันที การกลืนถ่านกระดุมสามารถทำให้เกิดแผลไหม้ภายในอย่างรุนแรงภายใน 2 ชั่วโมงและอาจนำไปสู่ความตายได้
- ▶ เมื่อเปลี่ยน ให้ตรวจสอบให้แน่ใจว่าได้เปลี่ยนถ่านกระดุมอย่างถูกต้อง อื่นรายจากการระเบิด
- ▶ ใช้เฉพาะถ่านกระดุมที่ระบุไว้ในคู่มือการใช้งานเท่านั้น อย่าใช้ถ่านกระดุมอื่นๆ หรือแหล่งให้พลังงานประเภทอื่น
- ▶ อย่าพยายามชาร์จถ่านกระดุมอีกครั้ง และอย่าลัดวงจรถ่านกระดุม ถ่านกระดุมอาจจรั่ว ระเบิด เผาไหม้ และทำให้บุคคลบาดเจ็บได้
- ▶ นำถ่านกระดุมทั้งหมดไฟแล้วออกมา และนำไปกำจัดอย่างถูกต้อง ถ่านกระดุมทั้งหมดไฟแล้วอาจจรั่วไหล และส่งผลเสียหายต่อผลิตภัณฑ์หรือทำให้บุคคลบาดเจ็บได้
- ▶ อย่าให้ถ่านกระดุมร้อนมากเกินไป และอย่าโยนเข้ากองไฟ ถ่านกระดุมอาจจรั่ว ระเบิด ไหม้ และทำให้บุคคลบาดเจ็บได้
- ▶ อย่าทำให้ถ่านกระดุมเสียหาย และอย่าถอดถ่านกระดุมออกจากกัน ถ่านกระดุมอาจจรั่ว ระเบิด ไหม้ และทำให้บุคคลบาดเจ็บได้
- ▶ อย่านำถ่านกระดุมที่เสียหายไปสัมผัสกับน้ำ ลิเทียมที่ออกมาแล้วสัมผัสกับน้ำสามารถผลิตไฮโดรเจนได้ และด้วยเหตุนี้จึงทำให้เกิดไฟไหม้ ระเบิด หรือบุคคลบาดเจ็บได้

- ▶ หากตัวยึดถ่านกระดุมปิดไม่สนิทและสนิทอีกต่อไป ให้หยุดใช้เครื่องมือวัด ถอดถ่านกระดุมออกและทำการซ่อมแซม

รายละเอียดผลิตภัณฑ์และข้อมูล

จำเพาะ

กรุณาดูภาพประกอบในส่วนหน้าของคู่มือการใช้งาน

ประโยชน์การใช้งานของเครื่อง

กล้องถ่ายภาพความร้อนนี้ใช้สำหรับวัดอุณหภูมิพื้นผิววัตถุแบบไม่สัมผัส

ภาพความร้อนที่แสดงจะบ่งบอกถึงการกระจายของอุณหภูมิของกล้องถ่ายภาพความร้อน และด้วยเหตุนี้จึงสามารถแสดงการเบี่ยงเบนของอุณหภูมิในลักษณะของสีที่แตกต่างกัน

ดังนั้นเมื่อใช้งานอย่างถูกต้อง คุณสามารถตรวจพื้นผิวและวัดอุณหภูมิความแตกต่างของอุณหภูมิหรือความโดดเด่นของอุณหภูมิโดยไม่สัมผัส เพื่อให้องค์กรเห็นส่วนประกอบและ/หรือจุดอ่อนใดๆ รวมทั้ง:

- ฉนวนกันความร้อนและฉนวน (เช่น การค้นพบสะพานความร้อน)
- ท่อส่งน้ำร้อนและน้ำอุ่นที่ทำงานอยู่ (เช่น ระบบทำความร้อนใต้พื้น) ในพื้นและผนัง
- ชิ้นส่วนไฟฟ้าที่ร้อนเกินไป (เช่น พิวส์หรือแคลมป์)
- ชิ้นส่วนเครื่องจักรที่ชำรุดหรือเสียหาย (เช่น ความร้อนสูงเกินไปเนื่องจากกลับลูกปืนชำรุด)

เครื่องมือวัดนี้ไม่เหมาะสำหรับใช้วัดอุณหภูมิก๊าซ

อย่าใช้อุปกรณ์วัดนี้สำหรับวัดอุณหภูมิที่มนุษย์และสัตว์ หรือเพื่อวัตถุประสงค์ทางการแพทย์อื่นๆ อย่างเด็ดขาด

เครื่องมือวัดนี้เหมาะสำหรับใช้งานทั้งภายในและภายนอกอาคาร

ส่วนประกอบที่แสดงภาพ

ลำดับเลขของส่วนประกอบอ้างอิงถึงส่วนประกอบของเครื่องมือวัดที่แสดงในหน้าภาพประกอบ

- (1) ฝาครอบป้องกันสำหรับกล้องมองและเซนเซอร์อินฟราเรด
- (2) หมายเลขเครื่อง
- (3) ฝาครอบพอร์ต USB
- (4) ซ็อกเก็ต USB Type-C®)
- (5) ปุ่มลูกศรชี้ขึ้นข้างบน
- (6) ปุ่มฟังก์ชัน Func
- (7) การเปลี่ยนสเกลอุณหภูมิ อัตโนมัติ-คงที่ / ปุ่มฟังก์ชันทางขวา
- (8) ปุ่มลูกศรขวา
- (9) ปุ่มเปิด/ปิด

- (10) มุมลูกศรชี้ลงข้างล่าง
- (11) มุมบันทึก
- (12) มุมลูกศรด้านซ้าย
- (13) ไมโครโฟน
- (14) มุมเกลเลอรี/มุมฟังก์ชันทางซ้าย
- (15) จอแสดงผล
- (16) ลำโพง
- (17) ช่องแบตเตอรี่
- (18) แบตเตอรี่ล็อคแบตเตอรี่แพ็ค^{b)}
- (19) แบตเตอรี่แพ็ค^{b)}
- (20) มุมวัด หูดหัวควรว/สตาร์ท
- (21) เซ็นเซอร์อินฟราเรด
- (22) กล้องมอง
- (23) สาย USB Type-C®

- a) USB Type-C® และ USB-C® เป็นเครื่องหมายการค้าของ USB Implementers Forum
- b) อุปกรณ์ประกอบที่แสดงภาพหรืออธิบายไม่รวมอยู่ในการจัดส่งมาตรฐาน

ชั้นส่วนแสดงผล

- (a) แสดงวันที่/เวลา
 - (b) แสดงอุณหภูมิเฉลี่ย
 - (c) แสดงอุณหภูมิที่สะท้อน
 - (d) สัญลักษณ์ คำสั่งประสิทธิภาพแฉ่งสี
 - (e) ไฟแสดงปิด/เปิด Wi-Fi®^{a)}
 - (f) ไฟแสดงสถานะการชาร์จ
 - (g) ไฟแสดงอุณหภูมิพื้นผิวสูงสุดในบริเวณวัด
 - (h) มาตรฐานส่วน
 - (i) ไฟแสดงอุณหภูมิพื้นผิวต่ำสุดในบริเวณวัด
 - (j) แก้วใสสัญลักษณ์มาตรฐานอุณหภูมิ
 - (k) ไฟแสดง จดร้อน (ตัวอย่าง)
 - (l) กากบาทพร้อมไฟแสดงอุณหภูมิ
 - (m) ไฟแสดง จุดเย็น (ตัวอย่าง)
 - (n) ไอคอนแกลลอรี่
- a) Wi-Fi® เป็นเครื่องหมายการค้าจดทะเบียนของ Wi-Fi Alliance®

ข้อมูลทางเทคนิค

กล้องถ่ายภาพความร้อน	GTC 600 C
หมายเลขสินค้า	3 601 K83 5..
ความละเอียด เซนเซอร์อินฟราเรด	256 × 192 px
ความไวการแยกแยะอุณหภูมิ ^{A)}	≤ 50 mK
ความยาวคลื่นที่ตรวจจับ	8–14 μm
มุมมองของภาพ (FOV) ^{B)}	45° × 35°
ระยะโฟกัส ^{B)}	≥ 0.3 ม.
โฟกัส	fix
ความไวต่อความร้อน	9 เซิร์ตซ์
บริเวณวัดอุณหภูมิพื้นผิว ^{B)}	-20 ... +600 °C
ความแม่นยำในการวัดอุณหภูมิพื้นผิว ^{B)(C)(D)}	
-20 ... ≤ +10 °C	±4 °C
> 10 ... ≤ 100 °C	±2 °C
> +100 °C	±2 %
ความละเอียดของอุณหภูมิ	0.1 °C
ความสูงใช้งานเหนือระดับอ้างอิง สูงสุด	2000 ม.
ระดับมลพิษตาม IEC 61010-1	2 ^{E)}

กล้องถ่ายภาพความร้อน	GTC 600 C
ค่าวัดความชื้นสัมพัทธ์สูงสุด ^{B)}	90 %
ชนิดจอแสดงผล	TFT
ขนาดจอแสดงผล	3.5"
ความละเอียดของหน้าจอ	320 × 240
รูปแบบไฟล์ภาพ	.jpg
รูปแบบขอดีโอ	.wav
รายการที่บันทึกไว้ต่อกระบวนการจัดเก็บ	1 × ภาพความร้อน (การจับภาพหน้าจอ), 1 × ภาพจริงที่ตาเห็นรวมทั้งค่าอุณหภูมิ (คำอธิบายข้อมูล), 1 × บันทึกเสียง หากจำเป็น
จำนวนภาพในหน่วยความจำภาพภายใน	600
จำนวนภาพในหน่วยความจำภาพภายในต่อทุกๆ 10 วินาที	350
ความละเอียดของกล้องมองเบ็ดเสร็จ	640 × 480 px
แบตเตอรี่แพ็ค (ลิเทียม-ไอออน)	10.8 V/12 V
อายุการใช้งานแบตเตอรี่ (ลิเทียม-ไอออน) ^{F)G)}	6 ชม.
พอร์ต USB	2.0
แหล่งจ่ายไฟฟ้า ระยะเวลาของระบบ	CR2032 (แบตเตอรี่ลิเทียม 3 V) ^{H)}
การเชื่อมต่อ-ไร้สาย	WLAN
กำลังส่ง WLAN สูงสุด	< 20 mW
ย่านความถี่ใช้งาน WLAN	2402–2480 เมกะเฮิร์ตซ์
น้ำหนักตามระเบียบการ EPTA-Procedure 01:2014	0.64–0.75 กก. ^{F)}
ขนาด (ความยาว × ความกว้าง × ความสูง)	115 × 102 × 231 มม.
ระดับการป้องกัน (ยกเว้นแบตเตอรี่ในตำแหน่งตั้งตรง)	IP54
สภาวะแวดล้อมที่อนุญาต	
– อุณหภูมิโดยรอบที่แนะนำเมื่อชาร์จ	0 ... +35 °C
– อุณหภูมิใช้งาน	-10 ... +45 °C
– สำหรับการจัดเก็บหากมีแบตเตอรี่แพ็ค	-20 ... +50 °C
– สำหรับการจัดเก็บโดยไร้แบตเตอรี่แพ็ค	-20 ... +70 °C
แบตเตอรี่ที่แนะนำ	GBA 10,8 V GBA 12 V

กล่องถ่ายภาพความร้อน

GTC 600 C

เครื่องชาร์จที่แนะนำ

GAL 12...

GAX 18...

- A) ตามมาตรฐาน VDI 5585 (ค่าเฉลี่ย)
 B) ตามมาตรฐาน VDI 5585
 C) ที่อุณหภูมิแวดล้อม 20–23 °C และค่าการแผ่รังสี > 0.999, ระยะการวัด: 0.3 ม., เวลาทำงาน: > 5 นาที, รูรับแสง 60 มม.
 D) บวกค่าความลาดเคลื่อนซึ่งขึ้นอยู่กับการใช้งาน (เช่น การสะท้อน ระยะทาง อุณหภูมิแวดล้อม)
 E) เกิดขึ้นเฉพาะมลพิษที่นำไฟฟ้า ยกเว้นบางครั้งนำไฟฟ้าได้ชั่วคราวที่มีสาเหตุจากการกัณฑ์ตัวที่คิดว่าจะเกิดขึ้น
 F) ขึ้นอยู่กับแบตเตอรี่แพ็คที่ใช้
 G) ที่อุณหภูมิแวดล้อม 20–30 °C
 H) ต้องเปลี่ยนถ่านกระดุมโดย Bosch หรือศูนย์บริการหลังการขายที่ได้รับอนุญาตสำหรับเครื่องมือไฟฟ้าของ Bosch
 ข้อมูลทางเทคนิคกำหนดโดยใช้แบตเตอรี่แพ็คที่จัดส่งมา

หมายเลขเครื่อง (2) บนแผ่นป้ายรุ่นมีไว้เพื่อระบุเครื่องมือวัดของคุณ

การติดตั้ง

การชาร์จแบตเตอรี่ (ดูภาพประกอบ A)

- ▶ **ใช้เฉพาะเครื่องชาร์จแบตเตอรี่ที่ระบุไว้ในข้อมูลทางเทคนิคนี้เท่านั้น** เฉพาะเครื่องชาร์จแบตเตอรี่เหล่านี้เท่านั้นที่ถูกออกแบบมาให้ใช้กับแบตเตอรี่แพ็คลิเทียม ไอออนที่ใช้ในเครื่องมือวัดของท่าน

หมายเหตุ: การใช้แบตเตอรี่แพ็คที่ไม่เหมาะสมสำหรับเครื่องมือวัดอาจทำให้เครื่องทำงานผิดปกติหรือเกิดความเสียหายได้

หมายเหตุ: แบตเตอรี่ที่จัดส่งมาถูกชาร์จมาแล้วบางส่วน เพื่อให้แน่ใจว่าแบตเตอรี่จะทำงานได้อย่างสมบูรณ์แบบ ให้ชาร์จแบตเตอรี่จนเต็มก่อนใช้งานครั้งแรก

แบตเตอรี่ลิเทียมไอออน

สามารถชาร์จได้ทุกเวลาโดยอายุการใช้งานจะไม่ลดลง การชดจั้งหะกระบวนการชาร์จไม่ทำให้แบตเตอรี่เสียหาย

สำหรับใส่แบตเตอรี่แพ็คที่ชาร์จแล้ว (19) ให้เลื่อนแบตเตอรี่แพ็คเข้าในช่องแบตเตอรี่ (17) จนเข้าล็อกอย่างเห็นได้ชัด สำหรับถอดแบตเตอรี่แพ็ค (19) ให้กดปุ่มปลดล็อก (18) และดึงแบตเตอรี่แพ็คออกจากช่องแบตเตอรี่ (17) **อย่าใช้กำลังดึง**

การปฏิบัติงาน

- ▶ **ป้องกันไม่ให้เครื่องมือวัดได้รับ ความชื้นและโดนแสงแดดส่องโดยตรง**
- ▶ **อย่าให้เครื่องมือวัดได้รับอุณหภูมิที่สูงมาก หรือรับอุณหภูมิที่เปลี่ยนแปลงมาก** ต. ย. เช่น อย่านำเครื่องวัดไว้ในรถยนต์เป็นเวลานานในกรณีที่อุณหภูมิมีการเปลี่ยนแปลงมาก ต้องปล่อยให้เครื่องมือวัดปรับตัวเข้ากับ

อุณหภูมิรอบตัวก่อนใช้งาน อุณหภูมิที่สูงมากหรืออุณหภูมิต่ำที่เปลี่ยนแปลงมากอาจส่งผลต่อความแม่นยำของเครื่องมือวัด

- ▶ **เอาใจใส่ให้เครื่องมือวัดปรับตัวเข้ากับสภาพอากาศอย่างถูกต้อง** หากอุณหภูมิมีความผันผวนมาก ระยะเวลาปรับตัวให้เข้ากับสภาพอากาศอาจนานถึง **60** นาที อาจเกิดกรณีนี้ได้ เช่น หากคุณเก็บเครื่องมือวัดไว้ในรถที่เย็นแล้ว และวัดในอาคารที่อบอุ่น

- ▶ **อย่าให้เครื่องมือวัดถูกกระแทกอย่างรุนแรงหรืออย่าให้ตกหล่น** หลังได้รับการกระทบจากภายนอกอย่างรุนแรง และเมื่อพบความผิดปกติในการทำงาน ท่านควรส่งเครื่องมือวัดไปตรวจสอบที่ศูนย์บริการลูกค้า **Bosch** ที่ได้รับมอบหมาย

การเริ่มต้นปฏิบัติงาน

การเปิด-ปิดเครื่อง

เมื่อต้องการวัด ให้เปิดฝาครอบป้องกัน (1) ขึ้น **ตรวจสอบให้แน่ใจว่า ขณะทำงานเซ็นเซอร์อินฟราเรดไม่ถูกปิดหรือบดบังไว้**

เปิดสวิตช์ เครื่องมือวัด โดยกดปุ่มเปิด-ปิด (9) บนจอแสดงผล (15) ปรากฏลำดับการบูต หลังลำดับการบูต เครื่องมือวัดจะเริ่มทำการวัดทันที และจะทำงานไปอย่างต่อเนื่อง จนกว่าจะปิดสวิตช์

หมายเหตุ: ในหน้าที่แรกๆ อาจเป็นไปได้ว่าเครื่องมือวัดมักจะปรับตุลตัวเองบ่อยๆ ทั้งนี้เพราะอุณหภูมิเซ็นเซอร์และอุณหภูมิล้อมรอบยังไม่ได้ปรับตัว การสอบเทียบเซ็นเซอร์ช่วยให้วัดได้อย่างแม่นยำ

ในช่วงเวลานี้สามารถทำเครื่องหมายการแสดงผลอุณหภูมิด้วย ~ ในระหว่างการสอบเทียบเซ็นเซอร์ ภาพความรอนจะหยุดค้างเป็นเวลานานๆ ผลกระทบนี้จะเพิ่มขึ้นตามความผันผวนอย่าง

รูนของขอมหุมิโดยรอบ ดังนั้นคุณควรเปิดเครื่องมือวัด สองสามมาที่ก่อนเริ่มการวัด เพื่อให้สามารถปรับความร้อนได้อย่างคงที่

ปิดสวิตช์เครื่องมือวัดโดยกดปุ่มเปิด-ปิด (9) อีกครั้ง เครื่องมือวัดบันทึกการตั้งค่าทั้งหมด จากนั้นจึงปิดสวิตช์เครื่อง ปิดฝาครอบป้องกัน (1) เพื่อจะได้ขนย้ายเครื่องมือวัดได้อย่างปลอดภัย

ในเมนูหลัก คุณสามารถเลือกว่าจะปิดสวิตช์เครื่องมือวัดปิดโดยอัตโนมัติหรือไม่และปิดสวิตช์หลังเวลาใด (ดู "เมนูหลัก", หน้า 50)

หากแบตเตอรี่หรือเครื่องมือวัดอยู่นอกอุณหภูมิการทำงานที่ระบุไว้ในข้อมูลทางเทคนิค เครื่องมือวัดจะปิดโดยอัตโนมัติหลังจากมีค่าเตือนสั้นๆ (ดู "ข้อผิดพลาด - สาเหตุและมาตรการแก้ไข", หน้า 53) ปรากฏขึ้น ปล่อยให้เครื่องมือวัดเย็นลงแล้วเปิดสวิตช์ใหม่อีกครั้ง

การเตรียมการวัด

ตั้งค่าการแผ่รังสีสำหรับการวัดอุณหภูมิพื้นผิว

ค่าสัมประสิทธิ์การแผ่รังสีของวัตถุขึ้นอยู่กับวัสดุและลักษณะพื้นผิวของวัสดุ ค่าดังกล่าวบ่งชี้ว่า วัตถุที่ปล่อยออกมา มีรังสีอินฟราเรดเท่าใดเมื่อเทียบกับการปล่อยรังสีความร้อนที่ต่ำสุด (ส่วนที่เป็นสีดำ, ค่าสัมประสิทธิ์การแผ่รังสี $\epsilon = 1$) และเป็นค่าระหว่าง 0 และ 1

สำหรับการกำหนดอุณหภูมิพื้นผิว เราจะวัดการแผ่รังสีความร้อนอินฟราเรดตามธรรมชาติที่ปล่อยออกมาจากวัตถุเป้าหมาย ซึ่งเป็นการวัดแบบไม่สัมผัส เพื่อให้ได้การวัดที่ถูกต้อง ต้องตรวจสอบค่าสัมประสิทธิ์การแผ่รังสีความร้อนที่ตั้งไว้ที่เครื่องมือวัดก่อนการวัดทุกครั้ง และปรับให้เข้ากับวัตถุที่วัด หากจำเป็น

ค่าสัมประสิทธิ์การแผ่รังสีความร้อนที่ตั้งไว้ล่วงหน้าในเครื่องมือวัดเป็นค่าชี้แนะ

ท่านสามารถเลือกค่าสัมประสิทธิ์การแผ่รังสีความร้อนที่ตั้งไว้ล่วงหน้าค่าใดค่าหนึ่ง หรือป้อนค่าตัวเลขที่แน่นอน ตั้งค่าสัมประสิทธิ์การแผ่รังสีความร้อนที่ต้องการใน

เมนู <Measurement (การวัด)> → <Emissivity> (ค่าสัมประสิทธิ์การแผ่รังสี) เมนู (ดู "เมนูหลัก", หน้า 50)

- ▶ ท่านสามารถวัดอุณหภูมิได้อย่างถูกต้องหากค่าสัมประสิทธิ์การแผ่รังสีความร้อนที่ตั้งไว้และค่าสัมประสิทธิ์การแผ่รังสีความร้อนของวัตถุสอดคล้องกัน

ยิ่งค่าสัมประสิทธิ์การแผ่รังสีความร้อนต่ำลงเท่าใด อิทธิพลของอุณหภูมิสะท้อนที่ต่อผลการวัดก็จะมากขึ้นเท่านั้น ดังนั้นหากคุณเปลี่ยนการแผ่รังสีให้ปรับอุณหภูมิสะท้อนเสมอ ตั้งค่าอุณหภูมิสะท้อนผ่านเมนู <Measurement (การวัด)> →

<Reflected Temp.> (อุณหภูมิสะท้อน) (ดู "เมนูหลัก", หน้า 50)

ความแตกต่างของสีจากเครื่องมือวัดอาจเป็นเพราะอุณหภูมิที่แตกต่างกันและ/หรือค่าสัมประสิทธิ์การแผ่รังสีความร้อนที่แตกต่างกัน หากค่าสัมประสิทธิ์การแผ่รังสีความร้อนแตกต่างกันมาก ความแตกต่างของอุณหภูมิที่แสดงอาจคลาดเคลื่อนจากความแม่นยำอย่างมีนัยสำคัญ

หากมีวัตถุที่วัดหลายชิ้นที่ห่างจากวัสดุที่แตกต่างกันหรือมีโครงสร้างที่แตกต่างกันในบริเวณวัด ค่าอุณหภูมิที่แสดงจะแม่นยำเฉพาะกับวัตถุที่เหมาะสมกับค่าสัมประสิทธิ์การแผ่รังสีความร้อนที่ตั้งไว้เท่านั้น สำหรับวัตถุอื่นๆ ทั้งหมด (ที่มีค่าสัมประสิทธิ์การแผ่รังสีความร้อนอื่นๆ) ความแตกต่างของสีที่แสดงสามารถนำมาใช้เป็นตัวบ่งชี้ความสัมพันธ์ของอุณหภูมิได้

ข้อสังเกตเกี่ยวกับเงื่อนไขการวัด

พื้นผิวที่สะท้อนแสงได้ดีหรือเป็นมันเงามาก (เช่น กระจกหรือโลหะที่เป็นมันวาว) อาจวัดเป็นได้อย่างมากหรือส่งผลกระทบต่อผลที่แสดง หากจำเป็น ให้ใช้เทปสีดำแบบด้านที่นำความร้อนได้ดีไปปิดที่พื้นผิวการวัด ปล่อยให้เทปปรับตัวให้เข้ากับอุณหภูมิบนพื้นผิวสักพัก

เมื่อพื้นผิวมีการสะท้อนแสง ให้หามุมวัดที่ดี เพื่อให้การแผ่รังสีความร้อนจากวัตถุอื่นๆ จะไม่ไปปิดบังผลจากการวัด ตัวอย่าง เช่น เมื่อวัดตามแนวตั้งจากด้านบน การสะท้อนของความร้อนในร่างกายที่แผ่ออกมาอาจมีผลต่อการวัด ในกรณีของพื้นผิวเรียบ อาจแสดงรูปทรงและอุณหภูมิของร่างกายของท่าน (ค่าสะท้อน) ซึ่งไม่สอดคล้องกับอุณหภูมิแท้จริงของพื้นผิวที่วัด (ค่าที่ปล่อยออกมาหรือค่าแท้จริงของพื้นผิว)

โดยหลักการแล้ว การวัดผ่านวัสดุโปร่งใส (ด. ย. เช่น แก้วหรือพลาสติกโปร่งใส) ไม่สามารถทำได้

ยังมีเงื่อนไขการวัดที่ดีกว่าและเสถียรกว่า ยังได้ผลการวัดที่ถูกต้องและน่าเชื่อถือยิ่งขึ้น ไม่เพียงแต่ความผันผวนของอุณหภูมิที่รุนแรงในสภาพแวดล้อมที่เกี่ยวข้องเท่านั้น แต่ความผันผวนอย่างรุนแรงของอุณหภูมิของวัตถุที่วัดได้อาจส่งผลให้ความแม่นยำลดลง

การวัดอุณหภูมิแบบอินฟราเรดจะได้รับผลกระทบจากควัน ไอน้ำ/ความชื้นสูง หรืออากาศที่เต็มไปด้วยฝุ่น

คำแนะนำสำหรับการวัดที่แม่นยำยิ่งขึ้น:

- เข้าใกล้วัตถุที่จะวัดให้มากที่สุดเท่าที่จะเป็นไปได้เพื่อลดปัจจัยรบกวนระหว่างตัวคุณและพื้นผิววัด
- ระบายอากาศพื้นที่ภายในก่อนทำการวัด โดยเฉพาะอย่างยิ่งเมื่ออากาศสกปรกหรือเต็มไปด้วยไอน้ำ หลังจากระบายอากาศแล้ว ปล่อยให้ห้องปรับตัวให้เข้ากับบรรยากาศสักพัก จนกว่าห้องจะกลับสู่อุณหภูมิปกติอีกครั้ง

การจัดหมวดหมู่อุณหภูมิด้วยสเกล

ที่ด้านขวาของจอแสดงผลคุณ将会เห็นสเกล (h) ค่าที่ปลายด้านบนและปลายด้านล่างขึ้นอยู่กับอุณหภูมิสูงสุด (g) หรืออุณหภูมิต่ำสุดที่ตรวจพบในภาพความร้อน (i) สำหรับมาตราส่วน จะประเมิน **99.9 %** ของพิกเซลทั้งหมด การจัดสรรสีให้กับค่าอุณหภูมิในภาพจะกระจายเท่าๆ กัน (เชิงเส้น)

อุณหภูมิจะถูกจัดหมวดหมู่ภายในค่าขอบเขตทั้งสองนี้ได้ด้วยเฉดสีต่างๆ กัน เช่น อุณหภูมิที่อยู่ระหว่างค่าสูงสุดและต่ำสุดพอดี อาจถูกจัดหมวดหมู่ให้อยู่ในช่วงสีตรงกลางของสเกล



เมื่อต้องการวัดอุณหภูมิของบริเวณเฉพาะเจาะจง ให้เคลื่อนเครื่องมือวัดโดยเล็งจากภาพพร้อมไฟแสดงอุณหภูมิ (I) ไปยังจุดหรือบริเวณที่ต้องการ ในการตั้งค่าอัตโนมัติ แถบสีของสเกลจะถูกกระจายไปทั่วบนบริเวณวัดทั้งหมดภายในอุณหภูมิสูงสุดและต่ำสุดเป็นเชิงเส้น (เท่าๆ กัน) เครื่องมือวัดแสดงอุณหภูมิที่วัดทั้งหมดที่สัมพันธ์ซึ่งกันและกันในบริเวณวัด หากในบริเวณหนึ่ง ตัวอย่าง เช่น ในการแสดงสีความร้อนในชุดสีปรากฏเป็นสีฟ้า นั่นหมายความว่าบริเวณสีฟ้าเป็นค่าการวัดที่เย็นกว่าในบริเวณวัดปัจจุบัน อย่างไรก็ตาม บริเวณเหล่านี้อาจอยู่ในช่วงอุณหภูมิที่อาจทำให้เกิดการบาดเจ็บภายใต้สถานการณ์บางอย่าง ดังนั้นให้ใส่ใจกับอุณหภูมิที่แสดงบนสเกลหรือที่จากภาพโดยตรงเสมอ

ฟังก์ชัน

การปรับการแสดงผล

ขึ้นอยู่กับสถานการณ์การวัด ชุดสีที่แตกต่างกันจะช่วยให้สามารถวิเคราะห์ภาพความร้อนได้ง่ายยิ่งขึ้น และแสดงวัตถุหรือข้อเท็จจริงบนจอแสดงผลได้ชัดเจนยิ่งขึ้น อุณหภูมิที่วัดจะไม่ได้รับผลกระทบจากการปรับชุดสี เฉพาะการแสดงผลออกของค่าอุณหภูมิเท่านั้นที่เปลี่ยนไป

เมื่อต้องการเปลี่ยนชุดสี ให้คงอยู่ในโหมดการวัดและกดปุ่มลูกศรขึ้นไปทางขวา (8) หรือซ้าย (12)

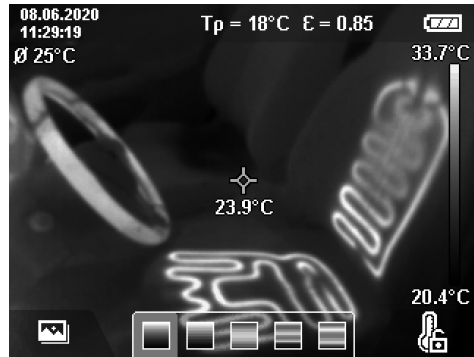

การซ้อนภาพความร้อนกับภาพจริง

เพื่อให้เห็นแนวทางดียิ่งขึ้น (= การจัดหมวดหมู่เชิงพื้นที่ของภาพความร้อนที่แสดง) ท่านสามารถเชื่อมต่อกับภาพจริงที่ตาเห็นในช่วงอุณหภูมิที่สมดุลได้ด้วย

หมายเหตุ: การซ้อนภาพความร้อนกับภาพจริงคือที่ระยะห่าง 0.55 ม. หากระยะทางไปยังวัตถุที่จะวัดแตกต่างกันไป ตามหลักการแล้วอาจทำให้ภาพความร้อนกับภาพจริงไม่ตรงกัน สามารถชดเชยได้ด้วยซอฟต์แวร์ถ่ายโอน GTC

เครื่องมือวัดนี้มีตัวเลือกต่อไปนี้:

- **ภาพอินฟราเรด 100 %**
แสดงเฉพาะภาพความร้อนเท่านั้น
- **ภาพความร้อนซ้อนบนภาพจริง**
ภาพความร้อนที่แสดงจะถูกตัดและบริเวณโดยรอบจะแสดงเป็นภาพจริง การตั้งค่านี้ช่วยให้จัดหมวดหมู่เฉพาะที่ของบริเวณวัดได้ดียิ่งขึ้น
- **ความโปร่งแสง**
ภาพความร้อนที่แสดงจะวางซ้อนแบบโปร่งแสงลงบนภาพจริง ดังนั้นจึงสามารถมองเห็นวัตถุได้ดีขึ้น

คุณสามารถปรับตั้งค่าได้โดยการกดปุ่มลูกศร (5) หรือลูกศรซ้าย (10) หรือลงข้างล่าง



การยืดสเกลอยู่กับที่

การกระจายของสีในภาพความร้อนถูกปรับโดยอัตโนมัติ แต่สามารถหยุดไว้ที่ส่วนนั้นได้โดยกดปุ่มฟังก์ชันทางขวา (7) ทำให้สามารถเปรียบเทียบภาพความร้อนที่บันทึกภายใต้สถานะอุณหภูมิที่แตกต่างกันได้ (เช่น เมื่อตรวจสอบสะพานระบายความร้อนในหลายห้อง) หรือซ่อนวัตถุที่เย็นจัดหรือร้อนจัดไว้ในภาพความร้อน ซึ่งอาจบิดเบือน (เช่น ใช้หมอน้ำเป็นวัตถุร้อนสำหรับการค้นหาสะพานความร้อน)

หากต้องการเปลี่ยนสเกลให้กลับมาเป็นแบบอัตโนมัติ ให้กดปุ่มฟังก์ชันทางขวา (7) อีกครั้ง ตอนนี้อุณหภูมิจะทำงานอย่างคล่องแคล่วอีกครั้ง และปรับตัวเข้ากับค่าสูงสุดและต่ำสุดที่วัดได้

ฟังก์ชันการวัด

เมื่อต้องการเข้าถึงฟังก์ชันอื่นๆ ที่สามารถช่วยคุณในการแสดงผล ให้กดปุ่ม **Func (6)** เลือกตัวเลือกต่างๆ ที่แสดงขึ้นเพื่อเลือกฟังก์ชันด้วยปุ่มลูกศรซ้าย (12) หรือขวา (8) เลือกหนึ่งฟังก์ชันและกดปุ่ม **Func (6)** อีกครั้ง

เครื่องนี้มีฟังก์ชันการวัดต่อไปนี้:

- **<Automatic> (อัตโนมัติ)**
การกระจายของสีในภาพความร้อนเป็นไปโดยอัตโนมัติ
- **<Heat Detector> (ตัวหารอน)**
ในฟังก์ชันการวัดนี้จะแสดงเฉพาะอุณหภูมิที่ร้อนขึ้นในบริเวณวัดเป็นภาพความร้อน บริเวณที่อยู่นอกอุณหภูมิที่ร้อนขึ้นนี้จะถูกแสดงเป็นภาพจริงในระดับสีเทา การแสดงผลเป็นโทนสีเทาช่วยป้องกันไม่ให้วัตถุสีส้มปนกับอุณหภูมิอย่างไม่ถูกต้อง (เช่น สายเคเบิลสีแดงในตู้ควบคุม) สำหรับส่วนประกอบที่ร้อนเกินไป ใช้ปุ่มลูกศรขึ้น (5) และลง (10) เพื่อปรับขนาด ช่วงอุณหภูมิที่แสดงจะขยายกว้างขึ้นหรือลดลงเป็นภาพความร้อน อุปกรณ์วัดจะวัดอุณหภูมิสูงสุดและต่ำสุดต่อไปและแสดงผลที่ปลายสเกล (h)
- **<Cold Detector> (ตัวหาเย็น)**
ในฟังก์ชันการวัดนี้จะแสดงเฉพาะอุณหภูมิที่เย็นลงในบริเวณวัดเป็นภาพความร้อน บริเวณที่อยู่นอกอุณหภูมิที่เย็นขึ้นนี้จะถูกแสดงเป็นภาพจริงในระดับสีเทา ทั้งนี้เพื่อไม่ให้วัตถุที่มีสีไปรวมอยู่ในอุณหภูมิเนื่องจากเข้าใจผิด (เช่น กรอบหน้าต่างสีฟ้าเมื่อคนทำการฉนวนฉนวนฉนวน) ใช้ปุ่มลูกศรขึ้น (5) และลง (10) เพื่อปรับขนาด ช่วงอุณหภูมิที่แสดงจะขยายกว้างขึ้นหรือลดลงเป็นภาพความร้อน อุปกรณ์วัดจะวัดอุณหภูมิสูงสุดและต่ำสุดต่อไปและแสดงผลที่ปลายสเกล (h)
- **<Manual> (ด้วยมือ)**
หากวัดอุณหภูมิที่แตกต่างกันมากในภาพความร้อน (เช่น เครื่องทำความร้อนเป็นวัตถุร้อนเมื่อตรวจสอบสะพานความร้อน) สีที่มีอยู่จะกระจายไปทั่วบนจออุณหภูมิจำนวนมากในช่วงระหว่างอุณหภูมิสูงสุดและต่ำสุด นี้อาจนำไปสู่ข้อเท็จจริงที่ว่าเครื่องไม่สามารถแสดงความแตกต่างของอุณหภูมิที่เล็กน้อยมากโดยอาจจะยืดอีกต่อไป เมื่อต้องการทราบรายละเอียดของช่วงอุณหภูมิที่จะตรวจสอบให้ทำตามขั้นตอนต่อไปนี้: หลังจากเปลี่ยนแปลงไปเป็นโหมด **<Manual> (ด้วยมือ)** แล้ว คุณสามารถตั้งค่าอุณหภูมิสูงสุดและต่ำสุด ด้วยวิธีนี้คุณสามารถกำหนดช่วงอุณหภูมิที่เกี่ยวข้องกับคุณ และช่วงอุณหภูมิที่คุณต้องการเห็น

ความแตกต่างที่เล็กน้อยมาก การตั้งค่า **<Reset scale> (รีเซ็ตสเกล)** จะปรับสเกลให้เหมาะสมกับค่าที่วัดในเขตมุมมองของเซ็นเซอร์อินฟราเรดโดยอัตโนมัติ

เมนูหลัก

เมื่อต้องการไปที่เมนูหลัก ให้กดปุ่ม **Func (6)** เพื่อเรียกดูฟังก์ชันการวัด จากนั้นกดปุ่มฟังก์ชันทางขวา (7)

- <Measurement (การวัด)>

- **<Emissivity> (ค่าสัมประสิทธิ์การแผ่รังสี) (d)**
สำหรับวัสดุที่ใช้บ่อยที่สุดบางประเภท เครื่องมีค่าสัมประสิทธิ์การแผ่รังสีที่บันทึกไว้แล้วให้เลือก เพื่อให้การค้นหาลงขั้น ค่าต่างๆ จะถูกจัดกลุ่มไว้ในแค็ตตาล็อกแสดงค่าสัมประสิทธิ์การแผ่รังสี เลือกในเมนู **<Material> (วัสดุ)** ก่อนเลือกหมวดหมู่ที่เหมาะสมและจากนั้นเลือกวัสดุที่เหมาะสม ค่าสัมประสิทธิ์การแผ่รังสีที่สอดคล้องกันจะแสดงในบรรทัดด้านล่าง หากคุณทราบค่าสัมประสิทธิ์การแผ่รังสีที่แน่นอนของวัตถุที่วัด คุณสามารถปรับตั้งค่านี้เป็นค่าตัวเลขในเมนู **<Emissivity> (ค่าสัมประสิทธิ์การแผ่รังสี)** หากคุณวัดวัสดุชนิดเดียวกันบ่อยครั้ง คุณสามารถบันทึก 5 ค่าสัมประสิทธิ์การแผ่รังสีเป็นรายการโปรดและเรียกใช้อย่างรวดเร็วผ่านแถบด้านบนได้ (เรียงลำดับ 1 ถึง 5)

- **<Reflected Temp.> (อุณหภูมิสะท้อน) (c)**
การตั้งค่าพารามิเตอร์เหล่านี้ช่วยปรับปรุงผลการวัดให้ดียิ่งขึ้น โดยเฉพาะอย่างยิ่งสำหรับวัสดุที่มีค่าสัมประสิทธิ์การแผ่รังสี (= การสะท้อนสูง) ในบางสถานการณ์ (โดยเฉพาะภายในอาคาร) อุณหภูมิที่สะท้อนจะสอดคล้องกับอุณหภูมิแวดล้อม หากวัตถุที่มีอุณหภูมิเย็นบนมากอยู่ใกล้กับวัตถุที่สะท้อนแสงมาก และสามารถส่งผลกระทบต่อการวัด ค่านี้ควรถูกปรับเปลี่ยนให้เหมาะสม

- <Display> (ไฟแสดง)

- **<Centerspot> (จุดกลาง) (l)**
จุดนี้จะแสดงอยู่ตรงกลางของภาพความร้อนและแสดงค่าอุณหภูมิที่วัดได้ ณ จุดนี้
- **<Hotspot> (จุดร้อน) (k): <ON> (เปิด)/<OFF> (ปิด)**
จุดที่ร้อนที่สุด (= พิกเซลการวัด) มีเครื่องหมายกากบาทสีแดงในภาพความร้อน ช่วยให้การค้นหาจุดวิกฤต (เช่น ขั้วสัมผัสหลวมในตู้ควบคุม) เพื่อการวัดที่แม่นยำที่สุด ให้ไฟที่สว่างที่สุดตรงกลางจอแสดงผล (85 × 64 พิกเซล) ด้วยวิธีนี้ ค่าอุณหภูมิที่สอดคล้องกันของวัตถุวัดนี้จะปรากฏขึ้น
- **<Coldspot> (จุดเย็น) (m): <ON> (เปิด)/<OFF> (ปิด)**
จุดที่เย็นที่สุด (= พิกเซลการวัด) มีเครื่องหมายกากบาท

สีฟ้าในภาพความร้อน ช่วยให้ง่ายต่อการค้นหาจุดวิกฤต (เช่น รอยร้าวในหน้าต่าง) เพื่อการวัดที่แม่นยำที่สุด ให้ โฟกัสวัตถุที่วัดตรงกลางจอแสดงผล (85 × 64 พิกเซล)

- **<Color Scale> (สเกลสี) (h): <ON> (เปิด)/ <OFF> (ปิด)**
- **<Average Temp. (อุณหภูมิเฉลี่ย)> (b): <ON> (เปิด)/<OFF> (ปิด)**

อุณหภูมิเฉลี่ย (b) จะแสดงที่ด้านซ้ายบนของภาพความร้อน (อุณหภูมิเฉลี่ยของค่าที่วัดได้ทั้งหมดในภาพความร้อน) วิธีนี้ช่วยให้คุณกำหนดอุณหภูมิสะท้อนได้ง่ายขึ้น

- **<WiFi> (e): <ON> (เปิด)/<OFF> (ปิด)**

(ดู "การถ่ายโอนข้อมูล", หน้า 52)

- **<Tool (เครื่อง)>**

- **<Language> (ภาษา)**

ภายใต้รายการเมนูนี้คุณสามารถเลือกภาษาที่ใช้ในการแสดงผล

- **<Time & Date> (เวลา & วันที่) (a)**

หากต้องการเปลี่ยนเวลาและวันที่ในเครื่องมือวัด ให้ไปที่เมนูย่อย **<Time & Date> (เวลา & วันที่)** ในเมนูย่อยนี้คุณไม่เพียงแต่ตั้งเวลาและวันที่เท่านั้น แต่ยังเปลี่ยนรูปแบบตามลำดับ หากต้องการออกจากเมนูย่อย **<Time> (เวลา)** และ **<Date> (วันที่)** ให้กดปุ่มฟังก์ชันด้านขวา (7), เพื่อบันทึกการตั้งค่าหรือปุ่มฟังก์ชันด้านซ้าย (14) เพื่อยกเลิกการเปลี่ยนแปลง

- **<Shutdown Time> (เวลาปิดสวิตช์)**

ภายใต้เมนูไอเทมนี้คุณสามารถเลือกช่วงเวลาที่เราเลือกเครื่องมือจะปิดสวิตช์โดยอัตโนมัติเมื่อไม่มีการกดปุ่มใดๆ คุณสามารถยังการปิดสวิตช์โดยอัตโนมัติโดยการตั้งค่า **<Never> (ไม่)** ไม่ได้ด้วย

- **<WiFi Channel (ช่องสัญญาณ WiFi)>**

คุณสามารถตั้งค่าช่องสัญญาณ Wi-Fi® อื่นภายใต้รายการเมนูนี้

- **<High audio quality (เสียงคุณภาพสูง)>**

ภายใต้รายการเมนูนี้ คุณสามารถปรับคุณภาพของไฟล์เสียงที่บันทึกผ่านบันทึกเสียงได้ โปรดทราบว่า เสียงคุณภาพสูงจำเป็นต้องใช้พื้นที่จัดเก็บมากขึ้น

- **<Tool Information> (ข้อมูลเครื่อง)**

ภายใต้เมนูไอเทมนี้ คุณสามารถเรียกดูข้อมูลเกี่ยวกับเครื่องมือวัด ตรงนี้ท่านจะพบหมายเลขเครื่องมือวัดและรุ่นซอฟต์แวร์ที่ติดตั้ง

- **<Factory settings (การตั้งค่าจากโรงงานผลิต)>**

ภายใต้รายการเมนูนี้ คุณสามารถรีเซ็ตเครื่องมือวัดกลับคืนค่าที่ตั้งจากโรงงานผลิตและลบข้อมูลทั้งหมดอย่างถาวร กระบวนการนี้อาจใช้เวลาหลายนาที กดปุ่มลูกศรขวา (8) สำหรับ **<More> (เพิ่มเติม)** เพื่อไปยังเมนู

ย่อย จากนั้นกดปุ่มฟังก์ชันทางขวา (7) เพื่อลบไฟล์ทั้งหมด หรือปุ่มฟังก์ชันทางซ้าย (14) เพื่อยกเลิกการดำเนินการ

หากต้องการออกจากเมนูใดๆ และกลับสู่หน้าจอการแสดงผลแบบมาตรฐาน คุณยังสามารถกดปุ่มวัด (20)

กระบวนการเก็บข้อมูลของผลการวัด

บันทึกผลการวัด

ทันทีหลังจากเปิดสวิตช์ เครื่องมือวัดจะเริ่มต้นทำการวัดและทำอย่างต่อเนื่องจนกว่าจะปิดสวิตช์

เมื่อต้องการบันทึกภาพ ให้เล็งกล้องไปยังวัตถุที่ต้องการวัด และกดปุ่มบันทึก (11) ภาพจะถูกเก็บไว้ในหน่วยความจำภายในของเครื่องมือวัด อีกทางเลือกหนึ่งคือกดปุ่มวัด (20) (หยุดชั่วคราว) กาวัดถูกหยุดไว้และแสดงผลบนจอแสดงผล วิธีนี้ช่วยให้คุณดูภาพอย่างละเอียดและปรับเปลี่ยนได้ในภายหลัง (เช่น จานสี) หากคุณไม่ต้องการบันทึกภาพที่หยุดไว้ ให้กลับไปทีใหม่การวัดอีกครั้งโดยกดปุ่มวัด (20) หากคุณต้องการจัดเก็บภาพในหน่วยความจำภายในของเครื่องมือวัด ให้กดปุ่มบันทึก (11)

บันทึกข้อความเสียง

เพื่อบันทึกสภาพแวดล้อมหรือข้อมูลเพิ่มเติมเกี่ยวกับภาพความร้อนที่บันทึกไว้ คุณสามารถบันทึกข้อความเสียงได้ ซึ่งจะบันทึกไว้นอกเหนือจากภาพความร้อนและภาพที่มองเห็นและสามารถถ่ายโอนได้ในภายหลัง

ขอแนะนำให้อัปโหลดบันทึกเสียงบันทึกสำหรับการบันทึกจัดทำเอกสารได้ดียิ่งขึ้น

บันทึกเสียงจะถูกบันทึกไว้ในแกลเลอรี ตำแหน่งการดังนี้:

- กดปุ่มฟังก์ชันด้านขวา (14) เพื่อเข้าสู่เมนูหลัก
- กดปุ่ม **Func (6)** การบันทึกจะเริ่มขึ้น บันทึกข้อมูลที่เกี่ยวข้องทั้งหมด
- สำหรับ **สิ้นสุดการบันทึก** ให้กดปุ่ม **Func (6)** อีกครั้ง หรือปุ่มฟังก์ชันด้านขวา (7)
- หากต้องการ **ยกเลิกการบันทึก** ให้กดปุ่มฟังก์ชันด้านซ้าย (14) หลังจากบันทึกแล้ว คุณสามารถฟังเสียงบันทึกได้
- หากต้องการ **ฟังการบันทึกเสียง** ให้กดปุ่ม **Func (6)** อีกครั้ง กำลังเล่นการบันทึก

- หากต้องการ **หยุดเล่นชั่วคราว** ให้กดปุ่มฟังก์ชันด้านขวา (7) หากต้องการเล่นต่อ ให้กดปุ่มฟังก์ชันด้านขวาอีกครั้ง (7)

- หากต้องการ **หยุดเล่น** ให้กดปุ่มฟังก์ชันด้านขวา (14) หากต้องการบันทึกเสียงใหม่ ให้ลบบันทึกเสียงที่มีอยู่แล้วเริ่มการบันทึกใหม่

โปรดทราบเมื่อบันทึก:

- ไมโครโฟน (13) จะอยู่ด้านหลังแป้นพิมพ์ถัดจากสัญลักษณ์ไมโครโฟน ชุดใส่ไมโครโฟน
- การบันทึกอาจใช้เวลาสูงสุด 30 วินาที

การเรียกดูภาพที่บันทึกไว้

เมื่อต้องการเรียกดูภาพความร่อนที่บันทึกไว้ให้ดำเนินการดังนี้:

- กดปุ่มฟังก์ชันทางซ้าย (14) ตอนนี้จะปรากฏภาพที่บันทึกไว้ล่าสุดในจอแสดงผล
- ในการสลับระหว่างภาพความร่อนที่เก็บไว้ ให้กดปุ่มลูกศรขึ้นไปทางขวา (8) หรือซ้าย (12)

นอกจากภาพความร่อนแล้วยังบันทึกภาพด้วย ในการเรียกขึ้นให้กดปุ่มลูกศรลง (10)

คุณยังสามารถดูภาพความร่อนที่บันทึกแบบเต็มหน้าจอได้โดยกดปุ่มลูกศรขึ้น (5) ในมุมมองแบบเต็มหน้าจอการแสดงผลและชื่อเรื่องจะหายไปหลังจากผ่านไป 3 วินาที เพื่อให้คุณสามารถดูรายละเอียดทั้งหมดของภาพความร่อนได้

คุณสามารถเปลี่ยนมุมมองได้โดยกดปุ่มลูกศรขึ้น (5) และลง (10)

การลบภาพและเสียงที่บันทึกไว้

เมื่อต้องการลบภาพความร่อนแต่ละภาพ หรือลบภาพทั้งหมดให้เปลี่ยนไปที่เมนูต่อไปนี้:

- กดปุ่มฟังก์ชันทางขวา (7) ได้อีกครั้งจะ เมื่อย่อยจะเปิดขึ้น ที่นี่คุณสามารถเลือกได้ว่า คุณต้องการลบเฉพาะภาพนี้เฉพาะบันทึกเสียงที่เกี่ยวข้องของ (หากคุณบันทึกไว้) หรือลบรูปภาพทั้งหมด หากคุณต้องการลบภาพนี้หรือบันทึกเสียงเท่านั้น ให้ยืนยันขั้นตอนโดยกดปุ่ม Func (6)
- หากคุณต้องการลบภาพทั้งหมดให้กดปุ่ม Func (6) หรือปุ่มฟังก์ชันด้านขวา (7) ยืนยันขั้นตอนโดยกดปุ่มฟังก์ชันด้านขวา (7) หรือยกเลิกการลบโดยกดปุ่มฟังก์ชันด้านซ้าย (14)

ขึ้นส่วนข้อมูลของภาพยังคงอยู่ในหน่วยความจำและสามารถสร้างขึ้นใหม่ได้ หากต้องการลบอย่างถาวรให้เลือกในเมนูหลัก <Tool (เครื่องมือ)> → <Factory settings (การตั้งค่าการโรงงานผลิต)>

การถ่ายโอนข้อมูล

ถ่ายโอนข้อมูลผ่านอินเทอร์เน็ต USB

เปิดฝาครอบพอร์ต USB Type-C® (3) เชื่อมต่อพอร์ต USB Type-C® (4) ของเครื่องมือวัดที่ปิดสวิตช์ขอยึดด้วยสาย USB Type-C® (23) ที่จัดส่งมาให้เข้ากับคอมพิวเตอร์ เปิดสวิตช์เครื่องมือวัดด้วยปุ่มเปิด-ปิด (9)

เปิดเบราว์เซอร์ไฟล์และเลือกไอคอน GTC 600 C คุณสามารถคลิกดลอปไฟล์ต่างๆ ที่บันทึกไว้จากหน่วยความจำภายในของเครื่องมือวัด ขยายไปยังคอมพิวเตอร์ของคุณ หรือลบออก

เมื่อสิ้นสุดการดำเนินการที่ต้องการ ให้ถอดการเชื่อมต่อโดยทำตามมาตรฐานออกจากคอมพิวเตอร์ และปิดสวิตช์เครื่องมือวัดด้วยปุ่มเปิด-ปิด (9) อีกครั้ง

ข้อควรระวัง: ให้ล็อกเอาท์โทรศัพท์จากระบบปฏิบัติการของคุณก่อนทุกครั้ง (eject โทรศัพท์) มิฉะนั้นหน่วยความจำภายในของเครื่องมือวัดอาจเสียหายได้

ถอดสาย USB Type-C® ระหว่างขั้นตอนการวัดและปิดฝาครอบ (3)

ปิดฝาครอบ USB-อินเทอร์เน็ตเฟสเสมอ ฟันละอองหรือน้ำที่สาดกระเด็นจะไม่ได้สามารถลอดเข้าไปในครอบเครื่องได้

หมายเหตุ: เชื่อมต่อเครื่องมือวัดผ่าน USB ด้วยคอมพิวเตอร์เท่านั้น ในขณะที่เชื่อมต่อเข้ากับอุปกรณ์อื่น เครื่องมือวัดอาจเสียหายได้

หมายเหตุ: ถ่ายโอนข้อมูลผ่านอินเทอร์เน็ตเฟส USB Type-C® เท่านั้น ไม่สามารถใช้อินเทอร์เน็ตและแบบเดสก์ท็อปได้

กระบวนการหลังการถ่ายภาพความร่อน

สามารถแก้ไขภาพความร่อนที่บันทึกไว้โดยใช้ระบบปฏิบัติการ Windows บนคอมพิวเตอร์ของคุณ เมื่อต้องการแก้ไขภาพให้ดาวน์โหลด GTC Transfer Software จากหน้าผลิตภัณฑ์ของเครื่องมือวัดที่

www.bosch-professional.com

การถ่ายทอดข้อมูลผ่าน WLAN

เครื่องมือวัดมีอินเทอร์เน็ตเฟส Wi-Fi® ติดตั้งอยู่ ซึ่งช่วยให้สามารถถ่ายที่บันทึกไว้โดยไร้สายจากเครื่องมือวัดไปยังอุปกรณ์เคลื่อนที่ปลายทางได้

มีแอปพลิเคชัน Bosch (Apps) พร้อมให้บริการโดยเฉพาะสำหรับการใช้งาน ท่านสามารถดาวน์โหลดแอปพลิเคชันเหล่านี้ตามประเภทอุปกรณ์ปลายทางได้จากแหล่งรวมแอปพลิเคชันที่เกี่ยวข้อง:



นอกเหนือไปจากการถ่ายทอดข้อมูลของรูปภาพของคุณแบบไร้สายแล้ว แอปพลิเคชัน Bosch ช่วยยังช่วยให้คุณสามารถขยายขอบเขตการทำงานเพิ่มขึ้น และลดความยุ่งยากของกระบวนการที่เกิดขึ้นที่หลัง รวมทั้งช่วยส่งต่อข้อมูลที่วัด (เช่นทางอีเมล) กรุณาค้นหาข้อมูลเกี่ยวกับความต้องการของระบบที่จำเป็นสำหรับการเชื่อมต่อ Wi-Fi® ได้ที่เว็บไซต์ของ Bosch www.bosch-professional.com

เมื่อต้องการเปิด-ปิดการเชื่อมต่อ Wi-Fi® ให้ไปที่เมนูหลักนำทางด้วยปุ่มเพื่อเลือก Wi-Fi® <WiFi> และเปิด-ปิดการใช้งาน หาก Wi-Fi® เปิดใช้งานอยู่ในหน้าจอแสดงผลจะปรากฏ (e) ตรวจสอบให้แน่ใจว่าอินเทอร์เน็ตเฟส Wi-Fi® บนอุปกรณ์เคลื่อนที่ปลายทางของท่านเปิดใช้งานอยู่

หลังจากแอปพลิเคชัน Bosch เริ่มทำงาน (เมื่อโมดูล Wi-Fi® ทำงานอยู่) จะสร้างการเชื่อมต่อระหว่างอุปกรณ์เคลื่อนที่ปลายทางและเครื่องมือวัด ปฏิบัติตามคำแนะนำการใช้แอปพลิเคชัน (App)

ข้อผิดพลาด - สาเหตุและมาตรการแก้ไข

ในกรณีที่มีข้อผิดพลาดเกิดขึ้น อุปกรณ์วัดจะรีบูตและสามารถนำมาใช้อีกครั้งในภายหลัง ไม่เช่นนั้นเมื่อมีข้อความแสดงความคิดเห็นอย่างถาวร การอธิบายนโดยสรุปด้านล่างนี้จะช่วยท่านได้

ข้อผิดพลาด	สาเหตุ	มาตรการแก้ไข
ไม่สามารถเปิดใช้งานเครื่องมือวัดได้	แบตเตอรี่หมดประจุ	ชาร์จแบตเตอรี่แพ็ค
	แบตเตอรี่แพ็คร้อนหรือเย็นเกินไป	ปล่อยให้แบตเตอรี่เย็นลงหรือเปลี่ยนแบตเตอรี่ใหม่ไป
	เครื่องมือวัดร้อนหรือเย็นเกินไป	ปล่อยให้เครื่องมือวัดทำอุณหภูมิไป
	หน่วยความจำภาพเต็มแล้ว หน่วยความจำภาพพวง	หากจำเป็น ให้โอนภาพไปยังสื่อบันทึกข้อมูลอื่น (เช่น คอมพิวเตอร์) จากนั้นให้ลบรูปภาพในหน่วยความจำภายใน ฟอร์แมตหน่วยความจำภายในโดยลบรูปภาพทั้งหมด หากยังคงเกิดปัญหายังคง ให้ส่งเครื่องมือวัดไปยังศูนย์บริการลูกค้า Bosch ที่ผ่านการรับรอง
	การส่งข้อมูลด้วยการเชื่อมต่อ Wi-Fi* ขำ	เปลี่ยนช่องสัญญาณ Wi-Fi* (ในเมนูหลัก <Tool (เครื่อง)> → <WiFi Channel (ช่องสัญญาณ WiFi)>)
	คอมพิวเตอร์ตรวจไม่พบเครื่องมือวัด	ตรวจสอบให้แน่ใจว่าไดรเวอร์ในคอมพิวเตอร์ของคุณเป็นเวอร์ชันล่าสุด อาจต้องใช้ระบบปฏิบัติการเวอร์ชันที่ใหม่กว่าในคอมพิวเตอร์
ไม่สามารถเชื่อมต่อเครื่องมือวัดกับคอมพิวเตอร์ได้	พอร์ตไมโคร USB หรือสายไมโคร USB ชำรุดเสียหาย	ตรวจสอบว่าเครื่องมือวัดสามารถเชื่อมต่อกับคอมพิวเตอร์เครื่องอื่นได้หรือไม่ หากไม่เป็นเช่นนั้น ส่งเครื่องมือวัดไปยังศูนย์บริการลูกค้า Bosch ที่ผ่านการรับรอง
	ถ่านกระดุมหมดประจุ	เข้ารับการเปลี่ยนถ่านกระดุมโดย Bosch หรือศูนย์บริการหลังการขายที่ได้รับอนุญาตสำหรับเครื่องมือไฟฟ้าของ Bosch
	เครื่องมือวัดชำรุด	ส่งเครื่องมือวัดไปยังศูนย์บริการลูกค้า Bosch ที่ผ่านการรับรอง

คำนิยาม

สามารถดูข้อมูลเพิ่มเติมได้ที่
www.bosch-professional.com

การแผ่รังสีความร้อนอินฟราเรด

รังสีความร้อนอินฟราเรดเป็นรังสีแม่เหล็กไฟฟ้าอุณหภูมิ 0 เคลวิน (-273 °C) ที่เปล่งจากทุกส่วนของร่างกาย ปริมาณรังสีขึ้นอยู่กับอุณหภูมิและการเปล่งรังสีของร่างกาย

ค่าสัมประสิทธิ์การแผ่รังสี

ค่าสัมประสิทธิ์การแผ่รังสีของวัตถุขึ้นอยู่กับวัสดุและลักษณะพื้นผิวของวัสดุ ค่าดังกล่าวบ่งชี้ว่า วัตถุที่ปล่อยออกมามีรังสี

อินฟราเรดเท่าใดเมื่อเทียบกับการปล่อยรังสีความร้อนที่สูงสุด (ส่วนที่เป็นสีดำ, ค่าสัมประสิทธิ์การแผ่รังสี $\epsilon = 1$) และเป็นค่าระหว่าง 0 และ 1

สะพานความร้อน

สะพานระบายความร้อนเป็นบริเวณบนผนังด้านนอกของอาคาร บริเวณโครงสร้างที่ส่งผลสูญเสียความร้อนเพิ่มขึ้นในพื้นที่นั้นๆ

สะพานความร้อนอาจทำให้เกิดความเสี่ยงต่อการเกิดเชื้อรา

อุณหภูมิสะท้อน/การสะท้อนกลับของวัตถุ

อุณหภูมิสะท้อนคือการแผ่รังสีความร้อนที่ไม่ได้ออกมาจากวัตถุเอง รังสีจากสิ่งแวดล้อมจะสะท้อนในวัตถุที่วัดทั้งนี้ขึ้นอยู่กับ

กับโครงสร้างและวัสดุ และดังนั้นจึงยึดเป็นผลอุณหภูมิที่แท้จริง

ระยะวัด

ระยะห่างระหว่างวัดที่วัดและเครื่องวัดมีอิทธิพลต่อขนาดพื้นที่ที่ตรวจจับต่อพิทเชล เมื่อระยะห่างวัดเพิ่มขึ้น คุณสมบัตินี้สามารถจับภาพวัตถุขนาดใหญ่ขึ้น

ระยะห่าง (ม.)	ขนาดพิทเชล อินฟราเรด (มม.)	ขอบเขต อินฟราเรด กว้าง x สูง (ม.)
0.3	1	0.25 × 0.19
0.55	2	~ 0.46 × 0.35
1	3	~ 0.83 × 0.63
2	6	~ 1.66 × 1.26
5	16	~ 4.14 × 3.15

การบำรุงรักษาและการบริการ

การบำรุงรักษาและการทำความสะอาด

จัดเก็บและขนย้ายเครื่องมือวัดโดยบรรจุในภาชนะที่เหมาะสม เช่น หีบห่อเดิม

รักษาเครื่องมือวัดให้สะอาดตลอดเวลา เช่น เซอร์อินฟราเรดที่สกปรก (21) อาจส่งผลต่อความแม่นยำในการวัด ขณะทำความสะอาด อย่าให้ของเหลวซึมเข้าไปในเครื่องมือวัด

อย่าพยายามใช้ของมีคมเพื่อขจัดสิ่งสกปรกออกจากเซ็นเซอร์อินฟราเรด (21), กล้อง (22) ลำโพง (16) หรือ ไมโครโฟน (13) อย่าขีดหรือขีดเซ็นเซอร์อินฟราเรดและกล้อง (เสี่ยงต่อการเกิดรอยขีดข่วน)

หากคุณต้องการเปรียบเทียบเครื่องมือวัดของคุณใหม่ โปรดติดต่อศูนย์บริการลูกค้า Bosch ที่ผ่านการรับรองในกรณีซ่อมแซม ให้ส่งเครื่องมือวัดโดยใส่ในหีบห่อเดิม ไม่มีชิ้นส่วนที่ผู้ใช้สามารถซ่อมบำรุงได้ในเครื่องมือวัด การเปิดเปลือกครอบเครื่องสามารถทำให้เครื่องมือวัดเสียหายได้

เปลี่ยนแบตเตอรี่กระดุมที่ติดตั้งในตัว

ต้องเปลี่ยนถ่านกระดุมโดย Bosch หรือศูนย์บริการหลังการขายที่ได้รับอนุญาตสำหรับเครื่องมือไฟฟ้าของ Bosch

- ▶ **โปรดทราบ:** **ต้องเปลี่ยนใช้ถ่านกระดุมประเภทเดียวกันเสมอ** อันตรายจากการระเบิด
- ▶ **นำถ่านกระดุมทั้งหมดไฟแล้วออกมา และนำไปกำจัดอย่างถูกต้อง** ถ่านกระดุมทั้งหมดไฟแล้วอาจรั่วไหล และส่งผลกระทบต่อผลิตภัณฑ์หรือทำให้บุคคลบาดเจ็บได้

การบริการหลังการขายและการให้คำปรึกษาการใช้งาน

ศูนย์บริการหลังการขายของเรายินดีตอบคำถามของท่านที่เกี่ยวกับการบำรุงรักษาและการซ่อมแซมผลิตภัณฑ์รวมทั้งเรื่องอะไหล่ ภาพเขียนแบบการประกอบและข้อมูลเกี่ยวกับอะไหล่ กรุณาดูใน: www.bosch-pt.com

ทีมงานที่ปรึกษาของ บอช ยินดีให้ข้อมูลเกี่ยวกับผลิตภัณฑ์ของเราและอุปกรณ์ประกอบต่างๆ

เมื่อต้องการสอบถามและสั่งซื้ออะไหล่ กรุณาแจ้งหมายเลขสินค้า 10 หลักบนแผ่นป้ายรุ่นของผลิตภัณฑ์ทุกครั้ง

ไทย

ไทย บริษัท โรเบิร์ต บอช จำกัด

เอพวยไอ เซ็นเตอร์ อาคาร 1 ชั้น 5

เลขที่ 2525 ถนนพระราม 4

แขวงคลองเตย เขตคลองเตย กรุงเทพฯ 10110

โทร: +66 2012 8888

แฟกซ์: +66 2064 5800

www.bosch.co.th

ศูนย์บริการซ่อมและฝึกอบรม บอช

อาคาร ลานชาลาทาวเวอร์ ชั้น G ห้องเลขที่ 2

บ้านเลขที่ 10/11 หมู่ 16

ถนนศรีนครินทร์ ตำบลบางแก้ว อำเภอบางพลี

จังหวัดสมุทรปราการ 10540

ประเทศไทย

โทรศัพท์ 02 7587555

โทรสาร 02 7587525

สามารถดูที่อยู่ศูนย์บริการอื่นๆ ได้ที่:

www.bosch-pt.com/serviceaddresses

การขนส่ง

แบตเตอรี่ลิเธียมไอออนที่แนะนำให้ใช้ อยู่ภายใต้ข้อกำหนดแห่งกฎหมายสินค้าอันตราย ผู้

ใช้สามารถขนส่งแบตเตอรี่แพ็คโดย

ทางถนนโดยไม่มีข้อยกเว้นหากขนส่งโดยบุคคลที่สาม

(เช่น : การขนส่งทางอากาศ หรือตัวแทนขนส่งสินค้า)

ต้องปฏิบัติตามข้อกำหนดพิเศษเกี่ยวกับการบรรจุ

ภัณฑ์และการติดฉลาก สำหรับการจัดเตรียมสิ่งของที่จะจัดส่ง

จำเป็นต้องปรึกษาผู้เชี่ยวชาญด้านวัตถุอันตราย

ส่งแบตเตอรี่แพ็คเมื่อตัวหุ้มไม่ชำรุดเสียหายเท่านั้น ใช้แถบ

กาวพันปิดหน้าสัมผัสที่เปิดอยู่ และนำแบตเตอรี่แพ็ค

ใส่กล่องบรรจุโดยไม่ให้เคลื่อนไปมาในกล่องได้ นอกจากนี้

นี้กรูณาปฏิบัติตามกฎระเบียบของประเทศซึ่งอาจมีรายละเอียดเพิ่มเติม

การกำจัดขยะ



เครื่องมือวัด แบตเตอรี่แพ็ค/แบตเตอรี่ อุปกรณ์ประกอบ และที่บล็อ ต้องนำไปแยกประเภทวัสดุเพื่อนำกลับมาใช้ใหม่โดยไม่ทำลายสภาพแวดล้อม



อย่าทิ้งเครื่องมือวัดและแบตเตอรี่แพ็ค/แบตเตอรี่ลงในขยะบ้าน!

แบตเตอรี่แพ็ค/แบตเตอรี่:

ลิเธียมไอออน:

กรุณาศึกษาปฏิบัติตามคำแนะนำในบทความขนส่ง (ดู "การขนส่ง", หน้า 54)

internal dan baterai dapat terbakar, berasap, meledak, atau mengalami panas berlebih.

- ▶ **Jika baterai tidak digunakan, jauhkan baterai dari klip kertas, uang logam, kunci, paku, sekrup, atau benda-benda kecil dari logam lainnya, yang dapat menjembatani kontak-kontak.** Korsleting antara kontak-kontak baterai dapat mengakibatkan kebakaran atau api.
- ▶ **Hanya gunakan baterai pada produk yang dibuat oleh produsen.** Hanya dengan cara ini, baterai dapat terlindungi dari kelebihan muatan.
- ▶ **Hanya isi ulang daya baterai menggunakan alat pengisi daya yang dianjurkan oleh produsen.** Alat pengisi daya baterai yang khusus untuk mengisi daya baterai tertentu dapat mengakibatkan kebakaran jika digunakan untuk mengisi daya baterai yang tidak cocok.



Lindungi baterai dari panas, misalnya juga dari paparan sinar matahari dalam waktu yang lama, api, kotoran, air dan kelembapan. Terdapat risiko ledakan dan korsleting.



- ▶ **Lindungi alat ukur, terutama area lensa inframerah, penguas suara, dan mikrofon dari kelembapan, salju, debu, dan kotoran. Lensa penerima dapat berembun atau terkontaminasi dan mendistorsi hasil pengukuran.** Pengaturan perangkat yang salah dan faktor-faktor atmosfer lainnya dapat menyebabkan kesalahan pengukuran. Objek dapat ditampilkan dengan suhu lebih tinggi atau lebih rendah yang dapat menimbulkan bahaya apabila disentuh.
- ▶ **Perbedaan suhu yang tinggi dalam citra termal dapat menyebabkan suhu tinggi yang ditunjukkan secara otomatis dengan suatu warna yang dikaitkan dengan suhu rendah.** Melakukan kontak dengan permukaan semacam ini dapat menyebabkan luka bakar.
- ▶ **Pengukuran suhu yang tepat hanya dapat dilakukan apabila emisivitas yang diatur dan emisivitas objek telah sesuai.** Objek dapat ditampilkan dengan suhu lebih tinggi atau lebih rendah yang dapat menimbulkan bahaya apabila disentuh.
- ▶ **Jangan arahkan alat ukur secara langsung di bawah sinar matahari atau pada laser daya tinggi CO₂.** Hal ini dapat menyebabkan kerusakan detektor.
- ▶ **Jangan letakkan alat ukur di atas baterai.** Alat ukur dapat terbalik dengan mudah. Alat ukur yang terjatuh dapat menyebabkan cedera.



Jauhkan magnet dari alat implan atau perangkat medis semacamnya, seperti misalnya alat pacu jantung atau pompa insulin. Magnet menciptakan medan yang dapat memengaruhi fungsi alat implan atau perangkat medis.

- ▶ **Jauhkan alat pengukur dari media data magnetis dan perangkat yang sensitif terhadap magnet.** Daya magnet dapat mengakibatkan data-data hilang secara permanen.

Bahasa Indonesia

Petunjuk Keselamatan



Semua petunjuk harus dibaca dan diperhatikan. Apabila alat ukur tidak digunakan sesuai dengan petunjuk yang disertakan, keamanan alat ukur dapat terganggu. **SIMPAN PETUNJUK INI DENGAN BAIK.**

- ▶ **Perbaiki alat ukur hanya di teknisi ahli resmi dan gunakan hanya suku cadang asli.** Dengan demikian, keselamatan kerja dengan alat ukur ini selalu terjamin.
- ▶ **Jangan mengoperasikan alat ukur di area yang berpotensi meledak yang di dalamnya terdapat cairan, gas, atau serbuk yang dapat terbakar.** Di dalam alat pengukur dapat terjadi bunga api, yang lalu menyulut debu atau uap.
- ▶ **Jangan membuka baterai.** Ada bahaya terjadinya korsleting.
- ▶ **Asap dapat keluar apabila terjadi kerusakan atau penggunaan yang tidak tepat pada baterai. Baterai dapat terbakar atau meledak.** Biarkan udara segar mengalir masuk dan kunjungi dokter apabila mengalami gangguan kesehatan. Asap tersebut dapat mengganggu saluran pernafasan.
- ▶ **Penggunaan yang salah pada baterai atau baterai yang rusak dapat menyebabkan keluarnya cairan yang mudah terbakar dari baterai. Hindari terkena cairan ini. Jika tanpa sengaja terkena cairan ini, segera bilas dengan air. Jika cairan tersebut terkena mata, segera hubungi dokter untuk pertolongan lebih lanjut.** Cairan yang keluar dari baterai dapat menyebabkan iritasi pada kulit atau luka bakar.
- ▶ **Baterai dapat rusak akibat benda-benda lancip, seperti jarum, obeng, atau tekanan keras dari luar.** Hal ini dapat menyebabkan terjadinya hubungan singkat

- ▶ **Alat ukur dilengkapi dengan antarmuka nirkabel. Perhatikan batasan pengoperasian lokal, misalnya dalam pesawat terbang atau di rumah sakit.**



PERINGATAN



Pastikan baterai kancing tidak berada dalam jangkauan anak-anak. Baterai kancing berbahaya.

- ▶ **Baterai kancing tidak boleh ditelan atau dimasukkan ke dalam rongga bagian tubuh. Jika terdapat indikasi baterai kancing tertelan atau telah masuk ke dalam rongga bagian tubuh, segera hubungi dokter.** Baterai kancing yang tertelan dapat menimbulkan luka bakar bagian dalam yang fatal dalam kurun waktu 2 jam dan dapat menyebabkan kematian.
- ▶ **Pastikan baterai kancing dipasang dengan benar saat mengganti baterai kancing.** Terdapat risiko ledakan.
- ▶ **Hanya gunakan baterai kancing yang tercantum dalam panduan pengoperasian ini.** Dilarang menggunakan baterai kancing atau suplai daya lainnya.
- ▶ **Jangan mencoba mengisi daya baterai kembali dan jangan membuat hubungan arus pendek pada baterai.** Baterai dapat bocor, meledak, terbakar, dan dapat melukai pengguna.
- ▶ **Lepas dan buang baterai kancing yang telah habis dengan cara yang ramah lingkungan.** Baterai kancing yang telah habis dapat bocor dan dapat merusak produk atau melukai pengguna.
- ▶ **Hindari baterai kancing dari panas berlebih dan jangan dibakar.** Baterai dapat bocor, meledak, terbakar, dan dapat melukai pengguna.
- ▶ **Jangan merusak baterai kancing dan jangan membongkar komponen baterai.** Baterai dapat bocor, meledak, terbakar, dan dapat melukai pengguna.
- ▶ **Jaga agar baterai kancing yang rusak tidak terkena air.** Kandungan lithium yang bocor keluar dapat menciptakan kandungan hidrogen dengan air dan dapat menimbulkan kebakaran, ledakan atau melukai pengguna.
- ▶ **Hentikan penggunaan alat ukur jika dudukan baterai kancing tidak dapat ditutup dengan benar dan sepenuhnya, lepaskan baterai kancing dan lakukan perbaikan.**

Spesifikasi produk dan performa

Perhatikan ilustrasi yang terdapat pada bagian depan panduan pengoperasian.

Tujuan penggunaan

Kamera citra termal ini dirancang untuk pengukuran tanpa kontak pada suhu permukaan.

Citra termal yang ditampilkan menunjukkan distribusi suhu area pandang dari kamera citra termal sehingga

memungkinkan untuk menunjukkan variasi suhu dengan warna yang berbeda.

Dengan demikian, jika digunakan dengan tepat, permukaan dan objek dapat diperiksa tanpa kontak terkait perbedaan atau ketidaknormalan suhu untuk melihat komponen dan/atau titik lemah, antara lain:

- Insulasi panas dan isolasi (misalnya penemuan jembatan termal),
- Pipa air panas dan hangat aktif (misalnya pemanas lantai) di lantai dan dinding,
- Komponen listrik yang terlalu panas (misalnya sekering atau terminal),
- Bagian mesin yang rusak atau malafungsi (misalnya overheat akibat bantalan bola yang rusak).

Alat ukur ini tidak sesuai untuk mengukur suhu gas.

Alat ukur ini tidak boleh digunakan untuk mengukur suhu manusia dan binatang atau tujuan medis lainnya.

Alat ukur ditujukan untuk digunakan di dalam maupun di luar ruangan.

Ilustrasi komponen

Nomor-nomor pada ilustrasi komponen sesuai dengan gambar alat pengukur pada halaman gambar.

- (1) Tutup pelindung untuk kamera visual dan sensor inframerah
- (2) Nomor seri
- (3) Penutup soket USB
- (4) Soket USB Type-C^{a)}
- (5) Tombol panah atas
- (6) Tombol fungsi pengukuran **Func**
- (7) Perubahan skala suhu otomatis – tetap/tombol fungsi kanan
- (8) Tombol panah kanan
- (9) Tombol on/off
- (10) Tombol panah bawah
- (11) Tombol Simpan
- (12) Tombol panah kiri
- (13) Mikrofoni
- (14) Tombol Galeri/tombol fungsi kiri
- (15) Display
- (16) Pengeras suara
- (17) Kompartemen baterai
- (18) Tombol pelepas baterai^{b)}
- (19) Baterai^{b)}
- (20) Tombol Jeda/Mulai pengukuran
- (21) Sensor inframerah
- (22) Kamera visual
- (23) Kabel USB Type-C[®]

a) USB Type-C[®] dan USB-C[®] merupakan merek dagang dari USB Implementer Forum.

b) **Aksesori yang digambarkan atau yang dijelaskan tidak termasuk dalam lingkup pengiriman standar.**

Elemen pada display

- (a) Display tanggal/waktu
- (b) Display suhu rata-rata
- (c) Display suhu yang dipantulkan
- (d) Indikator emisivitas
- (e) Indikator Wi-Fi® diaktifkan/dinonaktifkan^{a)}
- (f) Indikator level pengisian daya baterai
- (g) Indikator suhu permukaan maksimal dalam area pengukuran
- (h) Skala
- (i) Indikator suhu permukaan minimal dalam area pengukuran
- (j) Simbol Tentukan skala suhu
- (k) Indikator hotspot (contoh)
- (l) Tanda bidik dengan display suhu
- (m) Indikator coldspot (contoh)
- (n) Simbol Galeri

a) Wi-Fi® merupakan merek dagang terdaftar dari Wi-Fi Alliance®.

Data teknis

Kamera citra termal	GTC 600 C
Nomor model	3 601 K83 5..
Resolusi sensor inframerah	256 × 192 px
Sensitivitas termal ^{A)}	≤ 50 mK
Rentang spektral	8–14 μm
Area pandang (FOV) ^{B)}	45° × 35°
Jarak fokus ^{B)}	≥ 0,3 m
Fokus	Fix
Frame rate citra termal	9 Hz
Area pengukuran suhu permukaan ^{B)}	-20 ... +600 °C
Akurasi pengukuran suhu permukaan ^{B)(C)(D)}	
-20 ... +10 °C	±4 °C
> 10 ... ≤ 100 °C	±2 °C
> +100 °C	±2 %
Resolusi suhu	0,1 °C
Tinggi penggunaan maks. di atas tinggi acuan	2000 m
Tingkat polusi sesuai dengan IEC 61010-1	2 ^{E)}
Kelembapan udara relatif maks. ^{B)}	90 %
Jenis display	TFT
Ukuran display	3,5"
Resolusi display	320 × 240
Format gambar	.jpg
Format audio	.wav
Elemen yang disimpan tiap proses penyimpanan	1 × citra termal (tangkapan layar), 1 × citra acuan visual termasuk nilai suhu (metadata), jika perlu 1 × catatan suara
Jumlah gambar dalam memori gambar internal	600
Jumlah gambar dengan masing-masing 10 detik catatan suara dalam memori gambar internal	350
Resolusi kamera visual terintegrasi	640 × 480 px
Baterai (li-ion)	10,8 V/12 V
Durasi pengoperasian baterai (li-ion) ^{F)(G)}	6 h
Port USB	2.0
Suplai daya waktu sistem	CR 2032 (baterai lithium 3 V) ^{H)}
Konektivitas nirkabel	WLAN
Daya transmisi WLAN maks.	< 20 mW

Kamera citra termal	GTC 600 C
Rentang frekuensi pengoperasian WLAN	2402–2480 MHz
Berat sesuai dengan EPTA-Procedure 01:2014	0,64–0,75 kg ^{P)}
Dimensi (panjang × lebar × tinggi)	115 × 102 × 231 mm
Jenis perlindungan (kecuali baterai, dalam posisi tegak)	IP54
Kondisi sekitar yang diperbolehkan	
– Suhu sekitar yang direkomendasikan saat pengisian daya	0 ... +35 °C
– Suhu pengoperasian	–10 ... +45 °C
– Saat disimpan dengan baterai	–20 ... +50 °C
– Saat disimpan tanpa baterai	–20 ... +70 °C
Baterai yang direkomendasikan	GBA 10,8 V GBA 12 V
Perangkat pengisian daya yang direkomendasikan	GAL 12... GAX 18...

- A) Sesuai dengan standar VDI 5585 (nilai rata-rata)
 B) Sesuai dengan standar VDI 5585
 C) Jika suhu sekitar sebesar 20–23°C dan emisivitas sebesar > 0,999, jarak pengukuran: 0,3 m, waktu pengoperasian: > 5 menit, apertur sebesar 60 mm
 D) plus selisih yang bergantung pada penggunaan (misalnya pantulan, jarak, suhu sekitar)
 E) Hanya polusi nonkonduktif yang terjadi, namun terkadang muncul konduktivitas sementara yang disebabkan oleh kondensasi.
 F) tergantung pada baterai yang digunakan
 G) Pada suhu sekitar sebesar **20–30 °C**
 H) Penggantian baterai kancing harus dilakukan oleh Bosch atau pusat layanan pelanggan resmi untuk perkakas listrik Bosch.
 Data teknis ditentukan dengan baterai yang termasuk dalam lingkup pengiriman.

Alat ukur dapat diidentifikasi dengan jelas menggunakan nomor seri **(2)** pada label tipe.

Pemasangan

Mengisi daya baterai (lihat gambar A)

- ▶ **Hanya gunakan pengisi daya yang terdaftar dalam data teknis.** Hanya pengisi daya ini yang sesuai pada baterai Li-ion yang dapat digunakan untuk alat Anda.

Catatan: Menggunakan baterai yang tidak sesuai untuk alat ukur dapat menyebabkan kegagalan fungsi atau kerusakan pada alat ukur.

Catatan: Baterai dikirim dalam keadaan terisi sebagian. Untuk menjamin daya penuh dari baterai, lakukan pengisian baterai hingga penuh sebelum menggunakannya untuk pertama kali.

Daya baterai Li-ion dapat diisi setiap saat tanpa mengurangi masa pakainya. Penghentian proses pengisian daya tidak merusak baterai.

Untuk **memasang** baterai **(19)** yang telah terisi daya, masukkan baterai ke dalam kompartemen baterai **(17)** hingga terkunci dan terpasang secara merata pada gagang alat ukur.

Untuk **melepas** baterai **(19)**, tekan tombol pelepas **(18)** lalu keluarkan baterai dari kompartemen baterai **(17)**. **Jangan melepas baterai dengan paksa.**

Pengoperasian

- ▶ **Lindungilah alat pengukur dari cairan dan sinar matahari langsung.**
- ▶ **Jauhkan alat pengukur dari suhu atau perubahan suhu yang ekstrem.** Jangan biarkan alat pengukur berada terlalu lama di dalam kendaraan. Biarkan alat pengukur menyesuaikan suhu lingkungan sebelum dioperasikan saat terjadi perubahan suhu yang drastis. Pada suhu yang ekstrem atau terjadi perubahan suhu yang drastis, ketepatan alat pengukur dapat terganggu.
- ▶ **Perhatikan penyesuaian suhu yang tepat pada alat ukur.** Pada perubahan suhu yang ekstrem, waktu aklimatisasi dapat mencapai hingga **60** menit. Hal tersebut dapat terjadi misalnya ketika alat ukur disimpan di dalam mobil yang dingin dan kemudian dilakukan pengukuran di dalam bangunan yang hangat.
- ▶ **Jagalah supaya alat ukur tidak terbentur atau terjatuh.** Sebaiknya lakukan pemeriksaan di pusat layanan resmi **Bosch** setelah alat ukur terkena guncangan atau benturan keras dan saat mengalami kelainan fungsi.

Pengoperasian pertama kali

Menghidupkan/mematikan

Bukalah tutup pelindung **(1)** untuk mengukur. **Pastikan sensor inframerah tidak tertutup atau terhalang saat pengukuran berlangsung.**

Untuk **menghidupkan** alat ukur, tekan tombol on/off (9). Rangkaian start akan muncul pada display (15). Setelah muncul rangkaian start, alat ukur segera memulai pengukuran dan melanjutkannya secara terus-menerus hingga alat dimatikan.

Catatan: Di menit pertama, dapat saja alat ukur lebih sering mengkalibrasi secara otomatis karena suhu sensor dan suhu sekitar belum sesuai. Kalibrasi ulang sensor memungkinkan pengukuran yang tepat.

Selama waktu tersebut, display suhu dapat ditandai dengan ~. Selama kalibrasi sensor, citra termal akan berhenti untuk sementara waktu. Efek ini akan meningkat dengan fluktuasi suhu sekitar yang kuat. Oleh karena itu, jika memungkinkan, hidupkan alat ukur terlebih dulu selama beberapa menit sebelum memulai pengukuran agar alat dapat stabil secara termal.

Untuk **mematikan** alat ukur, tekan kembali tombol on/off (9). Alat ukur menyimpan semua pengaturan dan kemudian mati secara otomatis. Tutuplah tutup pelindung (1) agar menjamin keamanan pengangkutan alat ukur.

Pada menu utama terdapat pilihan apakah dan kapan alat ukur akan mati secara otomatis (lihat „Menu utama“, Halaman 61).

Jika baterai atau alat ukur tidak berada dalam rentang suhu pengoperasian yang telah ditentukan dalam data teknis, alat ukur akan mati secara otomatis setelah muncul peringatan singkat (lihat „Gangguan – Penyebab dan Solusi“, Halaman 63). Biarkan alat ukur menyesuaikan suhu sekitar dan kemudian hidupkan lagi.

Persiapan mengukur

Mengatur emisivitas untuk pengukuran suhu permukaan

Emisivitas suatu objek bergantung pada material dan struktur permukaannya. Emisivitas ini menunjukkan kuantitas radiasi panas inframerah yang dipancarkan objek bila dibandingkan dengan pemancar panas ideal (benda hitam, emisivitas $\epsilon = 1$) dan nilainya antara 0 dan 1.

Untuk menentukan suhu permukaan, radiasi panas inframerah alami akan diukur tanpa adanya kontak yang dipancarkan oleh objek tujuan. Untuk pengukuran yang tepat, emisivitas yang telah diatur pada alat ukur harus diperiksa **setiap sebelum pengukuran dilakukan** dan jika perlu, disesuaikan ke objek pengukuran.

Emisivitas yang telah diatur sebelumnya pada alat ukur menjadi nilai pedoman.

Anda dapat memilih salah satu emisivitas preset atau memasukkan nilai angka yang tepat. Atur emisivitas yang diinginkan melalui menu **<Pengukuran>** → **<Tingkat emisi>** (lihat „Menu utama“, Halaman 61).

► **Pengukuran suhu yang tepat hanya dapat dilakukan apabila emisivitas yang diatur dan emisivitas objek telah sesuai.**

Semakin rendah emisivitas, semakin besar pengaruh dari suhu yang terpantul pada hasil pengukuran. Oleh karena itu, selalu sesuaikan suhu yang terpantul jika emisivitas diubah.

Atur suhu yang terpantul melalui menu **<Pengukuran>** → **<Suhu dipantulkan>** (lihat „Menu utama“, Halaman 61).

Perkiraan perbedaan suhu yang ditampilkan oleh alat ukur dapat disebabkan oleh suhu yang berbeda dan/atau perbedaan emisivitas. Pada emisivitas yang sangat berbeda, perbedaan suhu yang ditunjukkan dapat sangat berbeda dari yang sebenarnya.

Jika terdapat beberapa objek pengukuran dari material yang berbeda atau struktur yang berbeda di area pengukuran, nilai suhu yang ditampilkan hanya akurat pada objek yang sesuai untuk emisivitas yang diatur. Untuk semua objek lain (dengan emisivitas yang berbeda), perbedaan warna yang ditampilkan dapat digunakan sebagai indikasi hubungan suhu.

Petunjuk mengenai kondisi pengukuran

Permukaan yang sangat reflektif atau mengilau (misalnya ubin atau logam yang mengilap) dapat sangat mendistorsi atau memengaruhi hasil yang ditampilkan. Bila perlu, pasang permukaan pengukuran dengan lakban hitam lebar sebagai konduktor yang baik. Biarkan lakban menyesuaikan suhu di permukaan secara singkat.

Pada permukaan yang memantul, pastikan sudut pengukuran telah sesuai sehingga radiasi panas yang dipantulkan dari objek lainnya tidak mendistorsi hasil. Misalnya, saat mengukur vertikal dari depan, pantulan panas tubuh sendiri yang terpancar dapat memengaruhi pengukuran. Untuk permukaan datar, garis bentuk dan suhu tubuh Anda dapat ditampilkan (nilai yang dipantulkan) yang mana tidak sesuai dengan suhu sebenarnya dari permukaan yang diukur (nilai yang dipancarkan atau nilai permukaan sesungguhnya).

Pengukuran melalui material yang transparan (misalnya kaca atau plastik transparan) pada dasarnya tidak dapat dilakukan.

Jika kondisi pengukuran lebih stabil dan lebih baik, hasil pengukuran dapat semakin tepat dan dapat diandalkan. Dengan demikian, fluktuasi suhu yang kuat tidak hanya relevan untuk kondisi lingkungan, melainkan fluktuasi suhu yang kuat pada objek yang diukur juga dapat memengaruhi keakuratan.

Pengukuran suhu inframerah dapat terganggu oleh asap, uap/tingkat kelembapan udara atau udara yang berdebu.

Petunjuk untuk akurasi pengukuran yang lebih baik:

- Berdirilah sedekat mungkin dengan objek pengukuran untuk meminimalkan faktor gangguan antara Anda dan permukaan pengukuran.
- Alirkanlah udara di ruangan sebelum mengukur, terutama bila udara kotor atau sangat lembap. Biarkan ruangan dialiri udara untuk menyesuaikan suhu hingga ruangan mencapai suhu normal.

Pengelompokan suhu menggunakan skala

Skala (**h**) ditampilkan di sisi kanan display. Nilai di ujung atas dan bawah mengacu pada suhu maksimal (**g**) atau suhu minimal (**i**) yang ditangkap pada citra termal. **99,9 %** dari total piksel dinilai untuk skala. Pembagian warna ke nilai suhu pada gambar dilakukan secara merata (linier).

Dengan penggunaan warna yang berbeda, suhu dapat ditetapkan dalam kedua nilai batas tersebut. Suhu yang terletak tepat di antara nilai maksimal dan minimal ditetapkan misalnya ke rentang warna tengah skala.



Untuk menentukan suhu pada area yang spesifik, gerakkan alat ukur sehingga tanda bidik dengan display suhu (**l**) mengarah ke titik atau area yang diinginkan. Dalam pengaturan otomatis, spektrum warna skala selalu dibagi ke seluruh area pengukuran dalam suhu maksimal atau minimal secara linier (= merata).

Alat ukur menampilkan semua suhu terukur dalam area pengukuran dalam hubungannya satu sama lain. Jika, di suatu area, misalnya dalam representasi warna, panas pada rentang warna ditampilkan kebiru-biruan, hal tersebut berarti bahwa area kebiruan tersebut termasuk dalam nilai pengukuran yang lebih dingin di area pengukuran saat ini. Namun, area ini mungkin masih berada dalam rentang suhu yang mungkin dapat menyebabkan cedera. Oleh karena itu, selalu perhatikan suhu yang ditampilkan pada skala atau langsung ke tanda bidik.

Fungsi

Menyesuaikan tampilan warna

Tergantung pada situasi pengukuran, rentang warna yang berbeda dapat mempermudah analisis citra termal dan dapat menampilkan benda atau objek secara lebih jelas pada display. Suhu yang diukur tidak terpengaruh oleh hal ini. Hanya tampilan nilai warna yang akan berubah.

Untuk mengubah rentang warna, tetapkan berada di mode pengukuran dan tekan tombol panah kanan (**8**) atau kiri (**12**).

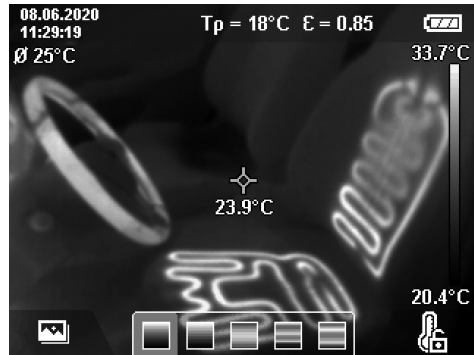

Tumpang tindih citra termal dan citra acuan

Untuk orientasi yang lebih baik (= penetapan ruang citra termal yang ditampilkan), citra acuan visual juga dapat diaktifkan pada rentang suhu seimbang.

Catatan: Tumpang tindih citra acuan dan citra termal mencakup tepat pada jarak 0,55 m. Perbedaan jarak terhadap objek pengukuran dapat menyebabkan ketidaksesuaian antara citra acuan dan citra termal. Ketidaksesuaian ini dapat diseimbangkan dengan GTC Transfer Software.

Alat ukur menawarkan pilihan berikut ini:

- **Citra inframerah 100%**
Display hanya menampilkan citra termal.
- **Gambar dalam gambar**
Citra termal yang ditampilkan ditunjukkan dalam potongan gambar dan area sekitarnya sebagai citra acuan. Pengaturan ini meningkatkan penetapan lokal area pengukuran.
- **Transparansi**
Citra termal yang ditampilkan diletakkan secara transparan di atas citra acuan. Dengan demikian, objek dapat dikenali dengan lebih baik.

Pengaturan dapat dipilih dengan menekan tombol panah atas (**5**) atau tombol panah bawah (**10**).



Menentukan skala

Distribusi warna pada citra termal disesuaikan secara otomatis, namun dapat ditentukan dengan menekan tombol fungsi kanan (7). Hal ini memungkinkan untuk membandingkan citra termal yang direkam dalam kondisi suhu yang berbeda (misalnya ketika memeriksa jembatan termal beberapa ruangan) atau untuk menyembunyikan objek yang sangat dingin atau panas pada citra termal yang sebaliknya akan mendistorsi objek (misalnya radiator sebagai objek panas saat mencari jembatan termal).

Untuk mengaktifkan kembali skala secara otomatis, tekan tombol fungsi kanan (7). Kini, suhu bergerak secara dinamis kembali dan menyesuaikan nilai minimal dan nilai maksimal yang terukur.

Fungsi pengukuran

Untuk mengakses fungsi lainnya yang dapat membantu Anda dalam melihat, tekan tombol **Func (6)**. Telusuri opsi yang ditampilkan dengan tombol panah kiri (12) atau tombol panah kanan (8) untuk memilih fungsi. Pilih satu fungsi dan tekan kembali tombol **Func (6)**.

Terdapat beberapa fungsi pengukuran berikut:

- <Otomatis>

Distribusi warna pada citra termal dilakukan secara otomatis.

- <Pelacak temperatur panas>

Dalam fungsi pengukuran ini, hanya suhu yang lebih hangat yang ditampilkan di area pengukuran sebagai citra termal. Area di luar suhu yang lebih hangat ini ditampilkan sebagai citra acuan dalam grayscale (derajat keabuan). Tampilan dalam grayscale mencegah kekeliruan dalam mengasosiasikan objek berwarna dengan suhu (misalnya kabel merah di kabinet kontrol saat mencari komponen yang overheated). Sesuaikan skala dengan tombol panah atas (5) dan tombol panah bawah (10). Dengan ini, rentang suhu yang ditampilkan ditambah atau dikurangi sebagai citra termal. Alat ukur tetap mengukur suhu minimal dan maksimal dan menampilkannya di ujung skala (h).

- <Pelacak temperatur dingin>

Dalam fungsi pengukuran ini, hanya suhu yang lebih dingin yang ditampilkan di area pengukuran sebagai citra termal. Area di luar suhu yang lebih dingin ini ditampilkan sebagai citra acuan dalam grayscale agar tidak keliru dalam mengasosiasikan objek berwarna dengan suhu (misalnya kusen jendela warna biru pada pencarian insulasi yang rusak). Sesuaikan skala dengan tombol panah atas (5) dan tombol panah bawah (10). Dengan ini, rentang suhu yang ditampilkan ditambah atau dikurangi sebagai citra termal. Alat ukur tetap mengukur suhu minimal dan maksimal dan menampilkannya di ujung skala (h).

- <Manual>

Jika suhu yang sangat berbeda diukur dalam citra termal (misalnya radiator sebagai objek panas saat memeriksa jembatan termal), warna yang tersedia didistribusikan pada nilai suhu yang tinggi dalam rentang antara suhu

maksimal dan minimal. Hal ini berarti perbedaan suhu yang tipis tidak lagi dapat ditampilkan secara rinci. Untuk mendapatkan tampilan detail dari rentang suhu yang akan diperiksa, lakukan hal berikut: Setelah beralih ke mode <Manual>, suhu maksimal atau suhu minimal dapat diatur. Oleh karena itu, rentang suhu yang tepat untuk Anda dan perbedaan suhu yang tipis yang ingin dideteksi dalam rentang suhu ini dapat ditentukan. Pengaturan <Atur ulang skala> akan menyesuaikan kembali skala secara otomatis dengan nilai-nilai yang diukur di area pandang sensor inframerah.

Menu utama

Untuk mengakses menu utama, tekan tombol **Func (6)** terlebih dulu untuk mengakses fungsi pengukuran. Kini, tekan tombol fungsi kanan (7).

- <Pengukuran>

• <Tingkat emisivi> (d)

Emisivitas yang tersimpan tersedia sebagai pilihan untuk beberapa material yang paling umum. Untuk mempermudah pencarian, nilai telah dikelompokkan dalam katalog emisivitas. Pertama, pilih kategori yang sesuai pada item menu <Material> dan kemudian material yang sesuai. Emisivitas terkait akan ditunjukkan pada baris di bawahnya. Apabila emisivitas yang tepat pada objek pengukuran diketahui, emisivitas tersebut juga dapat diatur dalam nilai angka pada item menu <Tingkat emisivi>. Jika material yang sama diukur berulang kali, 5 emisivitas dapat disimpan sebagai favorit dan dapat diakses dengan cepat melalui bar teratas (dinomori mulai 1 hingga 5).

• <Suhu dipantulkan> (c)

Pengaturan parameter ini dapat meningkatkan hasil pengukuran terutama pada material dengan emisivitas yang rendah (= pantulan tinggi). Dalam beberapa situasi (terutama di dalam ruangan), suhu yang dipantulkan sesuai dengan suhu sekitar. Jika benda dengan suhu yang sangat berbeda di dekat benda yang memantulkan kuat dapat memengaruhi pengukuran, nilai tersebut perlu disesuaikan.

- <Tampilan>

• <Titik tengah> (l)

Titik ditampilkan pada bagian tengah citra termal dan menunjukkan nilai suhu yang diukur pada area ini.

• <Hotspot> (k): <HIDUP>/<MATI>

Titik terpanas (= piksel pengukuran) ditandai dengan garis bidik merah pada citra termal. Hal tersebut memudahkan pencarian area yang kritis (misalnya terminal kontak yang longgar di kabinet kontrol). Untuk pengukuran paling akurat, fokuskan objek pengukuran di bagian tengah display (85 × 64 px). Dengan cara ini, nilai suhu yang sesuai dari objek pengukuran ini ditampilkan.

• <Titik dingin> (m): <HIDUP>/<MATI>

Titik terdingin (= piksel pengukuran) ditandai dengan garis bidik biru pada citra termal. Hal tersebut memudahkan pencarian area yang kritis (misalnya titik

yang bocor pada jendela). Untuk pengukuran paling akurat, fokuskan objek pengukuran di bagian tengah display (85 × 64 px).

- **<Skala warna> (h): <HIDUP>/<MATI>**
- **<Suhu rata-rata> (b): <HIDUP>/<MATI>**
Suhu rata-rata (b) ditampilkan di kiri atas citra termal (suhu rata-rata dari semua nilai yang diukur dalam citra termal). Hal tersebut dapat memudahkan untuk menentukan suhu yang dipantulkan.
- **<WiFi> (e): <HIDUP>/<MATI>**
(lihat „Pengiriman data“, Halaman 63)
- **<Perangkat>**
 - **<Bahasa>**
Pada item menu ini, bahasa yang digunakan pada display dapat dipilih.
 - **<Waktu & tanggal> (a)**
Untuk mengubah waktu dan tanggal pada alat ukur, akses submenu **<Waktu & tanggal>**. Pada submenu ini, selain mengatur waktu dan tanggal, tiap-tiap formatnya juga dapat diubah. Untuk keluar dari submenu **<Waktu>** dan **<Tanggal>**, tekan tombol fungsi kanan (7) untuk menyimpan pengaturan atau tekan tombol fungsi kiri (14) untuk membatalkan perubahan.
 - **<Waktu penonaktifan>**
Pada item menu ini, interval waktu dapat dipilih setelah alat ukur mati secara otomatis meski tidak ada tombol yang ditekan. Penonaktifan otomatis juga dapat dinonaktifkan dengan memilih pengaturan **<Tidak pernah>**.
 - **<Saluran WiFi>**
Saluran Wi-Fi® yang lainnya dapat diatur pada item menu ini.
 - **<Kualitas audio tinggi>**
Pada item menu ini, kualitas file audio yang direkam dapat disesuaikan melalui catatan suara. Perhatikan bahwa kualitas audio yang tinggi memerlukan lebih banyak memori penyimpanan.
 - **<Informasi alat>**
Pada item menu ini, informasi mengenai alat ukur dapat diakses. Di sana terdapat nomor seri alat ukur dan versi perangkat lunak yang diinstal.
 - **<Pengaturan pabrik>**
Pada item menu ini, alat ukur dapat diatur ulang ke pengaturan pabrik dan semua data dapat dihapus secara permanen. Hal tersebut dapat berlangsung selama beberapa menit. Tekan tombol panah kanan (8) selama **<Lebih>** untuk mengakses submenu. Kemudian, tekan tombol fungsi kanan (7) untuk menghapus semua file atau tekan tombol fungsi kiri (14) untuk membatalkan proses.

Tombol pengukuran (20) juga dapat ditekan untuk keluar dari menu apa pun dan kembali ke layar display standar.

Dokumentasi hasil pengukuran

Menyimpan hasil pengukuran

Begitu dihidupkan, alat ukur memulai pengukuran dan melanjutkannya secara terus-menerus hingga alat dimatikan.

Untuk menyimpan gambar, arahkan kamera ke objek pengukuran yang diinginkan dan tekan tombol Simpan (11). Gambar akan disimpan dalam memori internal alat ukur. Sebagai alternatif, tekan tombol pengukuran (20) (Jeda). Pengukuran akan dihentikan dan ditampilkan pada display. Hal ini memberikan Anda kesempatan untuk mengamati gambar dengan saksama dan menyesuaikan secara lebih lanjut (misalnya rentang warna). Jika gambar tersebut tidak ingin disimpan, tekan lagi tombol pengukuran (20) untuk masuk ke mode pengukuran. Jika gambar ingin disimpan dalam memori internal alat ukur, tekan tombol Simpan (11).

Merekam catatan suara

Catatan suara dapat digunakan untuk merekam kondisi lingkungan atau informasi tambahan mengenai citra termal yang disimpan. Selain citra termal dan gambar visual, catatan suara juga akan disimpan dan nantinya dapat dikirimkan.

Disarankan untuk merekam catatan suara guna memastikan dokumentasi yang lebih baik.

Perekaman catatan suara dilakukan di galeri. Lakukan hal berikut:

- Tekan tombol fungsi kiri (14) untuk mengakses galeri.
- Tekan tombol **Func (6)**. Perekaman dimulai. Rekam semua informasi yang relevan.
- Untuk **mengakhiri** perekaman, tekan kembali tombol **Func (6)** atau tombol fungsi kanan (7).
- Untuk **membatalkan** perekaman, tekan tombol fungsi kiri (14). Setelah merekam, catatan suara dapat didengarkan.
- Untuk **mendengarkan** rekaman, tekan kembali tombol **Func (6)**. Rekaman akan diputar.
 - Untuk **menjeda** pemutaran, tekan tombol fungsi kanan (7). Untuk memutar kembali perekaman yang dijeda, tekan ulang tombol fungsi kanan (7).
 - Untuk **menghentikan** pemutaran, tekan tombol fungsi kiri (14).

Untuk merekam catatan suara baru, hapus catatan suara yang ada lalu mulai perekaman baru.

Perhatikan saat melakukan perekaman:

- Mikrofon (13) berada di belakang keyboard di samping simbol mikrofon. Bicaralah ke arah mikrofon.
- Perekaman dapat berlangsung maksimal 30 detik.

Mengakses gambar yang tersimpan

Untuk mengakses citra termal yang disimpan, lakukan hal berikut:

- Tekan tombol fungsi kiri (14). Pada display kini akan muncul foto yang terakhir disimpan.
- Untuk beralih antara citra termal yang tersimpan, tekan tombol panah kanan (8) atau kiri (12).

Selain citra termal, gambar visual juga disimpan. Untuk mengakses citra termal, tekan tombol panah bawah (10). Citra termal yang direkam juga dapat ditampilkan dalam layar penuh dengan menekan tombol panah atas (5). Pada tampilan layar penuh, tampilan bilah judul akan menghilang

setelah 3 detik sehingga semua detail citra termal dapat diamati.

Tampilan dapat diganti dengan tombol panah atas (5) dan tombol panah bawah (10).

Menghapus gambar dan catatan suara yang tersimpan

Untuk menghapus satu atau semua citra termal, beralihlah ke tampilan galeri:

- Tekan tombol fungsi kanan (7) di bawah simbol tempat sampah. Sebuah submenu akan terbuka. Di sini tersedia pilihan apakah hanya ingin menghapus gambar ini, hanya catatan suara terkait (jika telah direkam) atau semua gambar. Jika hanya ingin menghapus gambar ini atau catatan suara, konfirmasi proses dengan tombol **Func (6)**.
- Jika semua gambar ingin dihapus, tekan tombol **Func (6)** atau tombol fungsi kanan (7), juga konfirmasi proses dengan tombol fungsi kanan (7) atau batalkan proses penghapusan dengan menekan tombol fungsi kiri (14).

Fragmen data gambar tetap berada dalam memori dan dapat dipulihkan. Untuk menghapus secara permanen, pilih **<Perangkat>** → **<Pengaturan pabrik>** pada menu utama.

Pengiriman data

Pengiriman data melalui port USB

Buka penutup soket USB Type-C® (3). Hubungkan soket USB Type-C® (4) alat ukur ke komputer menggunakan kabel USB Type-C® yang tersedia (23).

Kemudian, hidupkan alat ukur dengan tombol on/off (9).

Buka browser file pada komputer dan pilih hard drive **GTC 600 C**. File yang disimpan dapat disalin dari memori internal alat ukur, dihapus atau dipindahkan ke komputer.

Begitu proses yang diinginkan telah berakhir, putus sambungan hard drive dari komputer, kemudian matikan lagi alat ukur dengan tombol on/off (9).

Perhatian: Selalu lakukan log out pada hard drive dari sistem pengoperasian terlebih dulu (keluarkan hard drive) agar terhindar dari kerusakan pada memori internal alat ukur.

Lepaskan kabel USB Type-C® **selama** mengukur dan tutup penutup (3).

Selalu tutup antarmuka USB sehingga tidak ada debu atau percikan air yang bisa masuk ke dalam housing.

Catatan: Hanya sambungkan alat ukur ke komputer melalui USB. Jika disambungkan pada perangkat lain, alat ukur dapat menjadi rusak.

Catatan: Port USB Type-C® hanya berfungsi untuk pengiriman data. Baterai dan baterai isi ulang tidak dapat diisi daya menggunakan port ini.

Mengedit citra termal

Citra termal yang disimpan dapat diedit di komputer dengan sistem pengoperasian Windows. Unduh GTC Transfer Software dari halaman produk alat ukur di www.bosch-professional.com.

Pengiriman data melalui WLAN

Alat ukur dilengkapi dengan antarmuka Wi-Fi® yang memungkinkan pengiriman nirkabel gambar yang disimpan dari alat ukur ke perangkat seluler.

Aplikasi Bosch khusus (app) tersedia untuk penggunaan tersebut. Aplikasi ini dapat diunduh di setiap Stores terkait menyesuaikan jenis perangkat:









Selain mengirimkan data gambar secara nirkabel, aplikasi Bosch memungkinkan pengguna untuk meningkatkan fungsi dan menyederhanakan pemrosesan akhir serta mengirimkan data pengukuran (misalnya melalui e-mail). Informasi mengenai persyaratan sistem yang diperlukan untuk koneksi Wi-Fi® dapat ditemukan pada situs internet Bosch di www.bosch-professional.com.

Untuk mengaktifkan/menonaktifkan koneksi Wi-Fi® pada alat ukur, akses menu utama, arahkan dengan tombol untuk memilih **<WiFi>** dan aktifkan/nonaktifkan Wi-Fi. Saat Wi-Fi® diaktifkan, indikator (e) akan muncul pada display. Pastikan antarmuka Wi-Fi® pada perangkat seluler telah diaktifkan. Setelah aplikasi Bosch dimulai, koneksi antara perangkat seluler dan alat ukur dapat dibuat (dengan modul Wi-Fi® yang diaktifkan). Untuk itu, ikuti petunjuk aplikasi (app).

Gangguan – Penyebab dan Solusi

Jika terjadi gangguan, alat ukur akan melakukan start ulang dan dapat digunakan kembali. Jika tidak, ikhtisar di bawah akan membantu Anda jika terjadi pesan kesalahan terus-menerus.

Gangguan	Penyebab	Solusi
Alat ukur tidak dapat dihidupkan.	Baterai kosong	Isi daya baterai.
	Baterai terlalu panas atau terlalu dingin	Biarkan baterai menyesuaikan suhu sekitar atau ganti baterai.
	Alat ukur terlalu panas atau terlalu dingin	Biarkan alat ukur menyesuaikan suhu sekitar.

Gangguan	Penyebab	Solusi
	Memori gambar penuh	Jika perlu, pindahkan gambar ke media penyimpanan lainnya (misalnya komputer). Kemudian, hapus gambar di memori internal.
	Memori gambar rusak	Format memori internal dengan menghapus semua gambar. Jika masalah tetap muncul, kirimkan alat ukur ke layanan pelanggan resmi Bosch.
	Pengiriman data lambat saat menggunakan koneksi Wi-Fi®	Ubah saluran Wi-Fi® (pada menu utama di <Perangkat> → <Saluran WiFi>).
	Alat ukur tidak terdeteksi oleh komputer.	Pastikan driver pada komputer telah diperbarui. Kemungkinan diperlukan versi sistem pengoperasian terbaru pada komputer.
Alat ukur tidak dapat tersambung ke komputer.	Port USB atau kabel USB rusak	Pastikan alat ukur dapat disambungkan ke komputer lain. Jika tidak, kirimkan alat ukur ke layanan pelanggan resmi Bosch.
	Baterai kancing kosong	Lakukan penggantian baterai kancing oleh Bosch atau pusat layanan pelanggan resmi untuk perkakas listrik Bosch.
	Alat ukur rusak	Kirimkan alat ukur ke layanan pelanggan resmi Bosch.

Penjelasan istilah

Informasi lebih lanjut dapat ditemukan di www.bosch-professional.com.

Radiasi panas inframerah

Radiasi panas inframerah merupakan radiasi elektromagnetik yang dipancarkan oleh setiap benda di atas 0 Kelvin (-273°C). Jumlah radiasi bergantung pada suhu dan emisivitas tubuh.

Emisivitas

Emisivitas suatu objek bergantung pada material dan struktur permukaannya. Emisivitas ini menunjukkan kuantitas radiasi panas inframerah yang dipancarkan objek bila dibandingkan dengan pemancar panas ideal (benda hitam, emisivitas $\epsilon = 1$) dan nilainya antara 0 dan 1.

Jembatan termal

Jembatan termal merupakan posisi pada dinding luar bangunan di mana terjadi hilangnya panas yang meningkat secara lokal akibat konstruksinya.

Jembatan termal dapat meningkatkan risiko jamur.

Suhu yang dipantulkan/pantulan suatu objek

Suhu yang dipantulkan adalah radiasi panas yang tidak berasal dari benda itu sendiri. Radiasi sekitar akan memantul pada objek yang akan diukur sehingga mendistorsi hasil suhu yang sebenarnya bergantung pada struktur dan material.

Jarak objek

Jarak antara objek pengukuran dan alat ukur memengaruhi luas permukaan yang terdeteksi tiap piksel. Dengan memperbesar jarak objek, Anda dapat menangkap objek yang semakin besar.

Jarak (m)	Ukuran piksel inframerah (mm)	Area inframerah tinggi × lebar (m)
0,3	1	0,25 × 0,19
0,55	2	~ 0,46 × 0,35
1	3	~ 0,83 × 0,63
2	6	~ 1,66 × 1,26
5	16	~ 4,14 × 3,15

Perawatan dan servis

Perawatan dan pembersihan

Simpan dan angkut alat ukur hanya pada tempat yang sesuai seperti pada pembungkus aslinya.

Jaga kebersihan alat ukur. Sensor inframerah yang kotor (**21**) dapat memengaruhi akurasi pengukuran.

Hati-hati menggunakan caran saat membersihkan alat ukur agar cairan tidak masuk.

Jangan coba membersihkan kotoran sensor inframerah (**21**), kamera (**22**), pengeras suara (**16**) atau mikrofon (**13**) dengan benda tajam. Jangan mengusap sensor inframerah dan kamera (risiko tergores).

Apabila ingin melakukan kalibrasi ulang pada alat ukur, hubungi layanan pelanggan resmi Bosch.

Saat alat akan dibawa untuk diperbaiki, simpan alat ukur ke dalam pembungkus asli.

Pengguna tidak boleh memperbaiki komponen apa pun di dalam alat ukur. Alat ukur dapat rusak apabila housing dibuka.

Mengganti baterai kancing yang terintegrasi

Penggantian baterai kancing harus dilakukan oleh Bosch atau pusat layanan pelanggan resmi untuk perkakas listrik Bosch.

- ▶ **Perhatian: Selalu ganti baterai kancing dengan baterai kancing dengan jenis yang sama.** Terdapat risiko ledakan.
- ▶ **Lepas dan buang baterai kancing yang telah habis dengan cara yang ramah lingkungan.** Baterai kancing yang telah habis dapat bocor dan dapat merusak produk atau melukai pengguna.

Layanan pelanggan dan konsultasi penggunaan

Layanan pelanggan Bosch menjawab semua pertanyaan Anda tentang reparasi dan perawatan serta tentang suku cadang produk ini. Gambaran teknis (exploded view) dan informasi mengenai suku cadang dapat ditemukan di:

www.bosch-pt.com

Tim konsultasi penggunaan Bosch akan membantu Anda menjawab pertanyaan seputar produk kami beserta aksesorinya.

Jika Anda hendak menanyakan sesuatu atau memesan suku cadang, selalu sebutkan nomor model yang terdiri dari 10 angka dan tercantum pada label tipe produk.

Indonesia

PT Robert Bosch Indonesia
 Arkadia Green Park Tower G – 7th floor
 Jl. Let. Jend. TB. Simatupang Kav.88
 Jakarta 12520
 Tel.: (021) 3005 5800
 Fax: (021) 3005 5801
 E-Mail: boschpowertools@id.bosch.com
www.bosch-pt.co.id

Alamat layanan lainnya dapat ditemukan di:

www.bosch-pt.com/serviceaddresses

Transpor

Baterai li-ion yang direkomendasikan tunduk pada persyaratan terkait peraturan tentang bahan-bahan yang berbahaya. Baterai dapat diangkat di jalan oleh penggunanya tanpa pembatasan lebih lanjut.

Pada pengiriman oleh pihak ketiga (misalnya transportasi udara atau perusahaan ekspedisi) harus ditaati syarat-syarat terkait kemasan dan pemberian tanda. Dalam hal ini, diperlukan konsultasi dengan ahli bahan-bahan berbahaya saat mengatur barang pengiriman.

Kirimkan baterai hanya jika housing-nya tidak rusak. Tutup bagian-bagian yang terbuka dan kemas baterai agar tidak bergerak-gerak di dalam kemasan. Taatilah peraturan-peraturan nasional lainnya yang mungkin lebih rinci yang berlaku di negara Anda.

Cara membuang



Alat pengukur, aki/baterai, aksesoris dan kemasan harus disortir untuk pendauran ulang yang ramah lingkungan.



Jangan membuang alat pengukur dan baterai bersama dengan sampah rumah tangga!

Baterai:

Li-Ion:

Perhatikanlah petunjuk-petunjuk dalam bab Transpor (lihat „Transpor“, Halaman 65).

Tiếng Việt

Hướng dẫn an toàn



Đọc và tuân thủ tất cả các hướng dẫn. Khi sử dụng dụng cụ đo không phù hợp với các hướng dẫn ở trên, các thiết bị bảo vệ được tích hợp trong dụng cụ đo có thể bị suy giảm.

HÃY BẢO QUẢN CÁC HƯỚNG DẪN NÀY MỘT CÁCH CẨN THẬN.

- ▶ **Chỉ để người có chuyên môn được đào tạo sửa dụng cụ đo và chỉ dùng các phụ tùng gốc để sửa chữa.** Điều này đảm bảo cho sự an toàn của dụng cụ đo được giữ nguyên.
- ▶ **Không làm việc với dụng cụ đo trong môi trường dễ nổ, mà trong đó có chất lỏng, khí ga hoặc bụi dễ cháy.** Các tia lửa có thể hình thành trong dụng cụ đo và có khả năng làm rác cháy hay ngùn khói.
- ▶ **Không được tháo pin ra.** Nguy cơ bị chập mạch.
- ▶ **Trong trường hợp pin bị hỏng hay sử dụng sai cách, hơi nước có thể bốc ra. Pin có thể cháy hoặc nổ.** Hãy làm cho thông thoáng khí và trong trường hợp bị đau phải nhờ y tế chữa trị. Hơi nước có thể gây ngứa hệ hô hấp.
- ▶ **Khi sử dụng sai hoặc khi pin hỏng, dung dịch dễ cháy từ pin có thể tứa ra. Nếu vô tình chạm phải, hãy xối nước để rửa. Nếu dung dịch vào mắt, cần thêm sự hỗ trợ của y tế. Nếu chất lỏng dính vào mắt, yêu cầu ngay sự giúp đỡ của bác sĩ.** Dung dịch tiết ra từ pin có thể gây ngứa hay bỏng.
- ▶ **Pin có thể bị hư hại bởi các vật dụng nhọn như đinh hay tuốc-nơ-vít hoặc bởi các tác động lực từ bên ngoài.** Nó có thể dẫn tới đoản mạch nội bộ và làm pin bị cháy, bốc khói, phát nổ hoặc quá nóng.

- ▶ **Khi không sử dụng pin, để cách xa các vật bằng kim loại như kẹp giấy, tiền xu, chìa khoá, đinh, ốc vít hay các đồ vật kim loại nhỏ khác, thứ có thể tạo sự nối tiếp từ một đầu cực với một đầu cực khác.** Sự chập mạch của các đầu cực với nhau có thể gây bỏng hay cháy.
- ▶ **Chỉ sử dụng pin trong các sản phẩm của nhà sản xuất.** Chỉ bằng cách này, pin sẽ được bảo vệ tránh nguy cơ quá tải.
- ▶ **Chỉ được sạc pin lại với bộ nạp điện do nhà sản xuất chỉ định.** Một bộ nạp điện thích hợp cho một bộ pin nguồn có thể gây nguy cơ cháy khi sử dụng để nạp điện cho một bộ pin nguồn khác.



Bảo vệ pin không để bị làm nóng, ví dụ, chống để lâu dài dưới ánh nắng gay gắt, lửa, chất bẩn, nước, và sự ẩm ướt. Có nguy cơ nổ và chập mạch.



- ▶ **Bảo vệ dụng cụ đo, đặc biệt là các vùng của ống kính hồng ngoại, loa và micrô khô độ ẩm, tuyết và bụi bẩn. Ống kính thu nhận có thể bị đọng hơi hoặc bị nhiễm bẩn và cho kết quả đo sai.** Các điều chỉnh thiết bị sai cũng như các yếu tố ảnh hưởng khác có thể dẫn đến đo sai. Các vật thể có thể được hiển thị với nhiệt độ quá cao hoặc quá thấp, điều này có thể dẫn đến nguy hiểm khi tiếp xúc.
 - ▶ **Sự chênh lệch nhiệt độ cao trong ảnh nhiệt có thể dẫn tới các nhiệt độ cao được hiển thị bằng các màu, mà làm ta liên tưởng tới nhiệt độ thấp.** Tiếp xúc với bề mặt như thế có thể dẫn đến bỏng.
 - ▶ **Chỉ có các phép đo nhiệt độ chính xác, nếu thống nhất được độ phát xạ đã điều chỉnh và độ phát xạ của đối tượng.** Các vật thể có thể được hiển thị với nhiệt độ quá cao hoặc quá thấp, điều này có thể dẫn đến nguy hiểm khi tiếp xúc.
 - ▶ **Không hướng dụng cụ đo trực tiếp vào ánh nắng mặt trời hoặc vào tia laser hiệu suất cao CO₂.** Điều này có thể dẫn đến hỏng máy dò.
 - ▶ **Không đặt dụng cụ đo trên pin.** Máy có thể bị nghiêng nhẹ. Thương tích có thể xảy ra do rơi.
-  **Không để nam châm ở gần mô cấy hoặc các thiết bị y tế khác, ví dụ như máy trợ tim hoặc bơm insulin.** Từ tính có thể tạo ra một trường ảnh hưởng xấu đến chức năng của mô cấy hoặc các thiết bị y tế.
- ▶ **Để dụng cụ đo tránh xa các phương tiện nhớ từ tính và các thiết bị nhạy từ.** Ảnh hưởng của từ tính có thể gây ra mất dữ liệu không phục hồi được.
 - ▶ **Máy đo được trang bị một giao diện sóng vô tuyến.** Hãy chú ý các giới hạn địa điểm hoạt động ví dụ như trên máy bay hoặc bệnh viện.



CẢNH BÁO



Đảm bảo rằng pin nút áo không ở trong tay trẻ em.
Pin nút áo rất nguy hiểm.

- ▶ **Không bao giờ được nuốt pin nút áo hoặc nhét vào các chỗ hở trên cơ thể. Nếu nghi ngờ đã nuốt phải pin nút áo hoặc bị lọt vào một lỗ trên cơ thể, hãy đến bác sỹ ngay lập tức.** Việc nuốt pin nút áo có thể dẫn đến bỏng nặng bên trong và dẫn đến tử vong trong vòng 2 giờ.
- ▶ **Khi thay pin nút áo hãy chú ý thay pin đúng cách.** Sự nguy hiểm của nổ.
- ▶ **Chỉ sử dụng pin cúc áo được nêu trong hướng dẫn vận hành này.** Không sử dụng pin cúc áo khác hoặc một nguồn năng lượng khác.
- ▶ **Không cố sạc lại các pin nút áo và không làm chập mạch pin nút áo.** Pin nút áo có thể rò rỉ, phát nổ, cháy và gây thương tích cho người.
- ▶ **Tháo và xử lý các pin nút áo đã tháo xả đúng cách.** Các pin nút áo đã tháo xả có thể rò rỉ và do đó gây hư hỏng sản phẩm hoặc gây thương tích cho người.
- ▶ **Không làm quá nhiệt pin nút áo và không ném vào lửa.** Pin nút áo có thể rò rỉ, phát nổ, cháy và gây thương tích cho người.
- ▶ **Không phá hủy pin nút áo và không tháo dỡ pin nút áo.** Pin nút áo có thể rò rỉ, phát nổ, cháy và gây thương tích cho người.
- ▶ **Không để pin nút áo đã hỏng tiếp xúc với nước.** Lithium rò rỉ có thể tạo ra hydro cùng với nước và do đó dẫn đến cháy, nổ hoặc gây thương tích cho người.
- ▶ **Không sử dụng dụng cụ đo nữa, tháo pin nút áo và cho sửa chữa nếu ngăn pin nút áo không còn đóng đúng cách và hoàn toàn.**

Mô Tả Sản Phẩm và Đặc Tính Kỹ Thuật

Xin lưu ý các hình minh hoạt trong phần trước của hướng dẫn vận hành.

Sử dụng đúng cách

Camera ảnh nhiệt được thiết kế để đo nhiệt độ bề mặt mà không cần tiếp xúc chạm.

Ảnh nhiệt đã hiển thị sẽ cho biết sự phân bố nhiệt độ của trường nhìn camera ảnh nhiệt và cho phép hiển thị các chênh lệch nhiệt độ khác nhau theo màu.

Ví dụ, các bề mặt và các vật dụng có thể được kiểm tra về chênh lệch nhiệt hoặc sự bất thường nhiệt độ mà không cần chạm khi sử dụng đúng

cách, để khiến các chi tiết và/hoặc các chỗ yếu được thấy rõ:

- Lớp cách nhiệt và các lớp cách ly (ví dụ xác định cấu nhiệt),
- Các đường ống nước nóng hoạt động (ví dụ hệ thống sưởi ấm sàn) ở trên sàn và trong tường,
- Các bộ phận điện quá nhiệt (ví dụ cầu chì và thiết bị đầu cuối),
- Các bộ phận máy bị lỗi hoặc bị hỏng (ví dụ: quá nhiệt do ổ bị bị lỗi).

Dụng cụ đo không thích hợp để đo nhiệt độ chất khí.

Không được phép dùng thiết bị đo để đo nhiệt độ con người và động vật hoặc dùng cho các mục đích y tế khác.

Dụng cụ đo phù hợp để sử dụng trong vùng bên ngoài và bên trong.

Các bộ phận được minh họa

Sự đánh số các biểu trưng của sản phẩm là để tham khảo hình minh họa dụng cụ đo trên trang hình ảnh.

- (1) Nắp đậy bảo vệ của Camera trực quan và cảm biến hồng ngoại
- (2) Mã seri sản xuất
- (3) Vỏ giắc cắm USB
- (4) Ổ cắm USB-Type C^{®a)}
- (5) Phím nút tên trên
- (6) Nút Các chức năng đo **Func**
- (7) Thay đổi thang đo nhiệt độ tự động – được cố định/nút chức năng bên phải
- (8) Phím nút tên phải
- (9) Phím Bật/tắt
- (10) Nút nút tên xuống
- (11) Lưu nút
- (12) Phím nút tên trái

- (13) Micro
- (14) Nút bộ sưu tập/nút chức năng bên trái
- (15) Hiển thị
- (16) Loa
- (17) Cổng bộ nguồn
- (18) Nút mở khóa pin^{b)}
- (19) Pin^{b)}
- (20) Nút Tạm dừng/khởi động đo
- (21) Cảm biến hồng ngoại
- (22) Camera trực quan
- (23) Cáp USB Type-C[®]
 - a) USB Type-C[®] và USB-C[®] là các thương hiệu của điển đàn triển khai USB.
 - b) **Phụ tùng được trình bày hay mô tả không phải là một phần của tiêu chuẩn hàng hóa được giao kèm theo sản phẩm.**

Hiển thị các Phần tử

- (a) Hiển thị ngày/giờ
 - (b) Hiển thị nhiệt độ trung bình
 - (c) Hiển thị nhiệt độ phản chiếu
 - (d) Đèn chỉ thị độ phát xạ
 - (e) Hiển thị Wi-Fi[®] được bật/tắt^{a)}
 - (f) Bộ Chỉ Báo Tình Trạng Pin
 - (g) Hiển thị nhiệt độ bề mặt tối đa trong vùng đo
 - (h) Thước
 - (i) Hiển thị nhiệt độ bề mặt tối thiểu trong vùng đo
 - (j) Biểu tượng cố định thang nhiệt độ
 - (k) Hiển thị Điểm nóng (làm mẫu)
 - (l) Đường chữ thập với hiển thị nhiệt độ
 - (m) Hiển thị Điểm lạnh (làm mẫu)
 - (n) Biểu tượng Bộ sưu tập
- a) Wi-Fi[®] là nhãn hiệu đăng ký của Wi-Fi Alliance[®].

Thông số kỹ thuật

Camera Ảnh nhiệt	GTC 600 C
Mã hàng	3 601 K83 5..
Độ phân giải cảm biến hồng ngoại	256 × 192 px
Độ nhạy nhiệt độ ^{A)}	≤ 50 mK
Khoảng phổ	8–14 μm
Trường nhìn (FOV) ^{B)}	45° × 35°
Khoảng cách tiêu điểm ^{B)}	≥ 0,3 m
Tiêu điểm	Cố định
Độ làm mới ảnh cho ảnh nhiệt	9 Hz
Phạm vi đo nhiệt độ bề mặt ^{B)}	-20 ... +600 °C
Mức độ đo chính xác Nhiệt độ bề mặt ^{B)(C)(D)}	±4 °C

Camera Ảnh nhiệt	GTC 600 C
> 10 ... ≤ 100 °C	±2 °C
> +100 °C	±2 %
Độ phân giải nhiệt độ	0,1 °C
Chiều cao ứng dụng tối đa qua chiều cao tham chiếu	2000 m
Mức độ bắn theo IEC 61010-1	2 ^{E)}
Độ ẩm tương đối tối đa ^{B)}	90 %
Kiểu hiển thị	TFT
Kích thước hiển thị	3,5"
Độ phân giải màn hình hiển thị	320 × 240
Định dạng hình ảnh	.jpg
Định dạng audio	.wav
Phần tử đã lưu mỗi quá trình lưu	1 × ảnh nhiệt (Screenshot), 1 × ảnh thực trực quan gồm các giá trị nhiệt độ (lý lịch dữ liệu), 1 × Ghi chú bằng giọng nói nếu cần
Số lượng hình ảnh trong bộ nhớ hình ảnh trong	600
Số lượng hình ảnh trong bộ nhớ hình ảnh trong với mỗi ghi chú bằng giọng nói 10 s	350
Độ phân giải camera trực quan tích hợp	640 × 480 px
Pin hợp khối (Li-Ion)	10,8 V/12 V
Tuổi thọ pin (Li-Ion) ^{F)} ^{G)}	6 h
Cổng kết nối USB	2.0
Nguồn cung năng lượng thời gian hệ thống	CR2032 (Pin 3 V Lithium) ^{H)}
Khả năng kết nối không dây	WLAN
Năng suất truyền WLAN tối đa	< 20 mW
Dải tần số hoạt động WLAN	2402–2480 MHz
Trọng lượng theo Quy trình EPTA-Procedure 01:2014	0,64–0,75 kg ^{F)}
Kích thước (Chiều dài × Chiều rộng × Chiều cao)	115 × 102 × 231 mm
Kiểu bảo vệ (pin được ngoại trừ, ở vị trí thẳng đứng)	IP54
Các điều kiện xung quanh cho phép	
– Nhiệt độ môi trường được khuyến nghị khi sạc	0 ... +35 °C
– Nhiệt độ hoạt động	-10 ... +45 °C
– Khi lưu trữ có pin	-20 ... +50 °C
– Trong quá trình lưu trữ không có pin	-20 ... +70 °C
Pin được khuyến dùng	GBA 10,8 V GBA 12 V

Camera Ảnh nhiệt**GTC 600 C**

Thiết bị nạp được giới thiệu

GAL 12...

GAX 18...

- A) Theo tiêu chuẩn VDI 5585 (Giá trị trung bình)
- B) Theo tiêu chuẩn VDI 5585
- C) Với nhiệt độ xung quanh là 20–23 °C và Độ phát xạ là > 0,999, khoảng cách đo: 0,3 m, Thời gian vận hành: > 5 min, khẩu độ là 60 mm
- D) cộng với độ lệch phụ thuộc vào ứng dụng (ví dụ: phản xạ, khoảng cách, nhiệt độ môi trường)
- E) Chỉ có chất bán không dẫn xuất hiện, nhưng đôi khi độ dẫn điện tạm thời gây ra do ngưng tụ.
- F) tùy vào loại pin lồi đang sử dụng
- G) khi nhiệt độ môi trường xung quanh **20–30 °C**
- H) Pin cúc áo phải được thay thế bởi Bosch hoặc trung tâm dịch vụ khách hàng được ủy quyền dành cho dụng cụ điện Bosch.

Các dữ kiện kỹ thuật được xác định cho pin được giao cùng hàng hóa cung cấp.

Số seri (2) đều được ghi trên nhãn mác, để dễ dàng nhận dạng loại máy đo.

Sự lắp vào

Sạc pin (xem Hình A)

- ▶ **Chỉ sử dụng bộ sạc được đề cập trong dữ liệu kỹ thuật.** Chỉ những thiết bị nạp này phù hợp cho máy đo của bạn có sử dụng pin Li-Ion.

Hướng dẫn: Việc sử dụng pin không phù hợp với dụng cụ đo có thể dẫn đến lỗi chức năng hoặc gây hỏng dụng cụ đo.

Hướng dẫn: Pin đã được sạc một phần. Để đảm bảo hiệu suất tuyệt đối của pin, nên sạc đầy cho lần sử dụng đầu tiên.

Pin Li-Ion hợp khối có thể nạp điện bất cứ lúc nào mà không làm giảm tuổi thọ của pin. Sự gián đoạn trong quá trình nạp điện không làm hư hại pin hợp khối.

Để **lắp** pin đã nạp đầy (19) đẩy nó vào ngăn pin (17), cho đến khi khớp vào và nằm ngang bằng với tay cầm của máy đo.

Để **tháo** pin (19) hãy nhấn Phím mở khóa (18) và kéo pin ra khỏi khe pin (17). **Không dùng sức.**

Vận Hành

- ▶ **Bảo vệ dụng cụ đo tránh khỏi ẩm ướt và không để bức xạ mặt trời chiếu trực tiếp vào.**
- ▶ **Không cho dụng cụ đo tiếp xúc với nhiệt độ khắc nghiệt hoặc dao động nhiệt độ.** Không để nó trong chế độ tự động quá lâu. Điều chỉnh nhiệt độ cho dụng cụ đo khi có sự dao động nhiệt độ lớn, trước khi bạn đưa nó vào vận hành. Trong trường hợp ở trạng thái nhiệt độ cực độ hay nhiệt độ thay đổi thái quá, sự chính xác của dụng cụ đo có thể bị hư hỏng.
- ▶ **Chú ý tuân thủ chính xác các yếu tố thích nghi khí hậu của dụng cụ đo.** Trong trường hợp nhiệt độ dao động mạnh, thời gian thích nghi có thể lên đến **60** phút. Đây có thể là trường hợp, ví dụ, nếu bạn cất dụng cụ đo trong một chiếc xe

lạnh và sau đó thực hiện phép đo trong một tòa nhà ấm áp.

- ▶ **Tránh va chạm mạnh hoặc làm rơi dụng cụ đo.** Sau khi chịu những tác động bên ngoài nặng nề và có các bất thường về chức năng, bạn nên kiểm tra dụng cụ đo tại trung tâm dịch vụ có thẩm quyền của **Bosch**.

Bắt Đầu Vận Hành

Bật Mở và Tắt

Hãy gập nắp đậy bảo vệ lên để đo (1). **Khi làm việc hãy đảm bảo rằng cảm biến hồng ngoại không bị đóng kín hoặc bị che.**

Để **bật** dụng cụ đo, bạn hãy ấn phím bật/tắt (9). Trên màn hình (15) xuất hiện một trình tự khởi động. Sau thứ tự khởi động, dụng cụ đo sẽ bắt đầu bằng việc đo và sẽ tiếp tục cho đến khi bị tắt.

Hướng dẫn: Trong vài phút đầu tiên, dụng cụ đo có thể tự điều chỉnh, bởi vì nhiệt độ cảm biến và nhiệt độ xung quanh vẫn chưa được điều chỉnh. Việc điều chỉnh lại cảm biến sẽ cho phép đo chính xác.

Trong thời gian này, hiển thị nhiệt độ có thể được đánh dấu bằng ~. Trong lúc điều chỉnh cảm biến, ảnh nhiệt sẽ đóng băng trong thời gian ngắn. Hiệu ứng này tăng lên khi nhiệt độ môi trường xung quanh dao động mạnh. Do đó, nếu có thể, hãy bật dụng cụ đo vài phút trước khi bắt đầu đo để nó có thể ổn định nhiệt.

Để **tắt** dụng cụ đo, bạn hãy ấn lại nút bật/tắt (9). Máy đo sẽ lưu tất cả thiết lập và sau đó tự ngắt. Hãy đóng nắp đậy bảo vệ (1) để vận chuyển an toàn dụng cụ đo.

Trong menu chính bạn có thể chọn xem dụng cụ được tắt sau thời gian nào (xem „Menu chính“, Trang 72).

Nếu pin hoặc dụng cụ đo nằm ngoài nhiệt độ làm việc được chỉ định trong dữ liệu kỹ thuật, dụng cụ đo sẽ tự động tắt sau khi có cảnh báo ngắn (xem „Lỗi – Nguyên nhân và biện pháp khắc phục“, Trang 74). Để dụng cụ đo nguội bớt rồi bật lại.

Chuẩn bị đo

Đặt độ phát xạ cho các phép đo nhiệt độ bề mặt

Độ phát xạ của một vật phụ thuộc vào nguyên vật liệu và cấu trúc bề mặt của vật đó. Nó cho biết vật thể phát ra bao nhiêu bức xạ nhiệt hồng ngoại so với một bộ tản nhiệt lý tưởng (vật đen, độ phát xạ $\epsilon = 1$) và theo đó là giá trị từ 0 đến 1.

Để xác định nhiệt độ bề mặt, bức xạ nhiệt hồng ngoại tự nhiên sẽ được đo không tiếp xúc, phát tới đối tượng mục tiêu. Để có các phép đo chính xác, phải kiểm tra độ phát xạ đã được điều chỉnh tại máy đo **trước mỗi phép đo** và có thể điều chỉnh tại đối tượng đo nếu có thể.

Các độ phát xạ đặt trước trong dụng cụ đo là các giá trị tiêu chuẩn.

Bạn có thể chọn một trong nhiều độ phát xạ hoặc nhập một giá trị số chính xác. Hãy điều chỉnh độ phát xạ mong muốn qua menu **<Đo>** → **<Độ phát xạ>** (xem „Menu chính“, Trang 72).

► Chỉ có các phép đo nhiệt độ chính xác, nếu thống nhất được độ phát xạ đã điều chỉnh và độ phát xạ của đối tượng.

Độ phát xạ càng thấp, ảnh hưởng của nhiệt độ phản xạ đến kết quả đo càng lớn. Do đó, nếu bạn thay đổi độ phát xạ, hãy luôn điều chỉnh nhiệt độ phản xạ. Hãy điều chỉnh độ phát xạ mong muốn qua menu **<Đo>** → **<Nhiệt độ phản xạ>** (xem „Menu chính“, Trang 72).

Sự chênh lệch nhiệt độ được hiển thị bởi dụng cụ đo có thể được phân bố cho nhiều mức nhiệt độ khác nhau và/hoặc nhiều độ phát xạ khác nhau. Nếu các độ phát xạ khác biệt nhiều thì các khác biệt về nhiệt độ đã hiển thị có thể sai lệch đáng kể với giá trị thực.

Nếu có càng nhiều đối tượng đo làm từ nhiều loại nguyên vật liệu hoặc cấu trúc khác nhau trong một vùng đo, thì các giá trị nhiệt độ đã hiển thị chính xác ở những đối tượng đo phù hợp với độ phát xạ được điều chỉnh. Đối với tất cả đối tượng khác (với các độ phát xạ khác) các khác biệt về màu có thể được sử dụng dưới dạng hướng dẫn về tỷ lệ màu.

Ghi chú về các điều kiện đo

Các bề mặt phản chiếu lóa hoặc sáng chói (như gạch lát hoặc kim loại trơn) có thể làm sai hoặc gây ảnh hưởng lớn đến các kết quả đã hiển thị. Hãy dán mặt đo lại bằng băng dính xin màu có thể dẫn nhiệt tốt nếu cần thiết. Hãy để băng dính cân bằng trên bề mặt một lát.

Chú ý tới góc đo thuận tiện tại các diện tích phản chiếu sao cho bức xạ nhiệt phản chiếu của vật thể khác không làm sai lệch kết quả đo. Ví dụ, khi đo mà theo chiều dọc từ phía trước, hiện tượng phản chiếu nhiệt độ cơ thể tỏa ra của bạn có thể gây ảnh hưởng đến phép đo. Đối với một bề mặt phẳng thì các đường nét và nhiệt độ của cơ thể có thể được hiển thị (giá trị phản chiếu), xem nhiệt độ nào

không tương ứng với bề mặt được đo (giá trị đã phát hoặc giá trị thực của bề mặt).

Về lý thuyết, không thể thực hiện phép đo qua chất liệu trong suốt (ví dụ như thủy tinh hoặc nhựa trong suốt).

Các kết quả đo sẽ càng chính xác và đáng tin cậy khi các điều kiện đo tốt hơn và ổn định hơn. Không chỉ có sự dao động nhiệt độ mạnh trong điều kiện môi trường xung quanh, mà cả sự dao động mạnh về nhiệt độ của đối tượng được đo cũng có thể làm giảm độ chính xác.

Phép đo nhiệt độ bằng hồng ngoại có thể bị ảnh hưởng xấu bởi khói, hơi/độ ẩm không khí cao hoặc không khí bụi bặm.

Hướng dẫn về độ chính xác cao hơn của các phép đo:

- Hãy đến gần vật thể nhất để giảm thiểu các yếu tố gây nhiễu giữa ben và bề mặt đo.
- Bạn cần thông khí ở bên trong trước khi đo phòng này, đặc biệt khi không khí bị ô nhiễm hoặc rất ẩm thấp. Hãy để căn phòng cân bằng sau khi thông khí, cho tới khi phòng đạt nhiệt độ thông thường.

Gán nhiệt độ dựa vào thang đo

Ở phía bên phải màn hình hiển thị một thang đo **(h)** được hiển thị. Các giá trị ở đầu trên và đầu dưới sẽ là nhiệt độ tối đa **(g)** hoặc tối thiểu thu được trong ảnh nhiệt **(i)**. **99,9 %** tổng Pixel được đánh giá cho thang đo. Sự chỉ định màu cho một giá trị nhiệt độ trong ảnh được thực hiện đồng đều (tuyến tính).

Với nhiều tông màu khác nhau, các mức nhiệt độ sẽ được chỉ định cho cả hai giá trị biên này. Mức nhiệt độ, mà nằm chính xác giữa giá trị tối thiểu và tối đa, được chỉ định cho vùng màu giữa của thang đo.



Để xác định nhiệt độ của vùng cụ thể bạn hãy di chuyển dụng cụ đo, để đường chữ thập có hiển thị nhiệt độ **(l)** chỉ vào điểm mong muốn hoặc vùng mong muốn. Trong thiết lập tự động, quang phổ màu của thang đo luôn được phân bố tuyến tính (đồng đều) lên toàn bộ vùng đo trong nhiệt độ tối thiểu hoặc tối đa.

Trong dụng cụ đo tất cả các nhiệt độ đã đo sẽ được hiển thị trong vùng đo tỷ lệ với nhau. Nếu, trong một vùng, ví dụ trong hiển thị màu, mà nhiệt được hiển thị màu xanh dương trong thang màu, thì tức là vùng xanh dương thuộc các giá trị đo lạnh trong vùng đo hiện tại. Tuy nhiên các vùng này có thể vẫn nằm trong khoảng nhiệt độ, mà có thể dẫn đến hướng tích. Do đó hãy lưu ý các nhiệt độ đã hiển thị trên thang đo hoặc trên đường chữ thập.

Chức năng

Điều chỉnh hiển thị màu

Tùy theo tình huống đo mà các bảng màu khác biệt có thể giúp phân tích ảnh nhiệt và minh họa đối tượng hoặc thực trạng rõ ràng hơn trong màn hình hiển thị. Do đó nhiệt độ đo được không bị ảnh hưởng. Chỉ có hiển thị giá trị nhiệt độ là thay đổi. Để thay đổi bảng màu bạn hãy duy trì chế độ đo và nhấn nút mũi tên bên phải (8) hoặc bên trái (12).

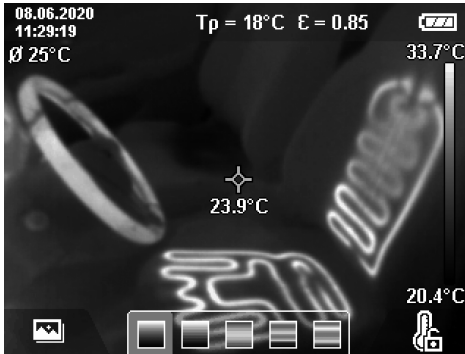

Giao thoa ảnh nhiệt và ảnh thực

Để định hướng tốt hơn (= bố trí không gian cho ảnh nhiệt đã hiển thị) một ảnh thực trực quan sẽ được bật bổ sung đối với các khoảng nhiệt độ cân chỉnh.

Hướng dẫn: Giao thoa ảnh nhiệt và ảnh thực là chính xác ở khoảng cách 0,55 m. Nếu cách khoảng cách tối đối tượng đo bị chênh lệch thì về nguyên tắc có thể dẫn đến sai lệch giữa ảnh nhiệt và ảnh thực. Độ lệch này có thể được bù bằng phần mềm GTC Transfer.

Dụng cụ đo cho bạn các khả năng sau:

- **100 % Ảnh hồng ngoại**
Chỉ ảnh nhiệt được hiển thị.
- **Ảnh lồng Ảnh**
Ảnh nhiệt đã hiển thị được cất bớt và vùng xung quanh được hiển thị dưới dạng ảnh thực. Thiết lập này sẽ cải thiện việc bố trí vùng đo.
- **Độ trong suốt**
Ảnh nhiệt đã hiển thị được đặt trên ảnh thực với độ trong suốt. Như vậy các đối tượng có thể được nhận diện tốt hơn.

Bằng cách nhấn nút mũi tên lên (5) hoặc xuống (10) bạn có thể chọn thiết lập.

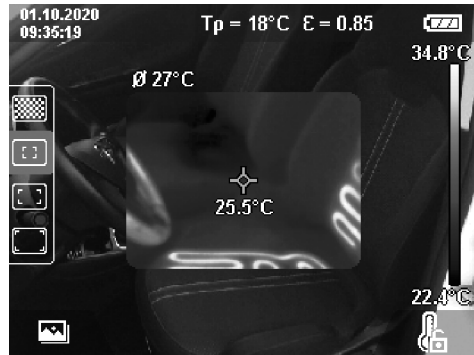

Cố định thang đo

Điều chỉnh sự phân bố màu trong ảnh nhiệt sẽ được thực hiện tự động, tuy nhiên việc này có thể được cố định do nhấn nút chức năng bên phải (7). Điều này cho phép so sánh các ảnh nhiệt đã được ghi lại theo các điều kiện nhiệt độ khác nhau (ví dụ khi kiểm tra nhiều không gian trên cầu nhiệt) hoặc ẩn một vật thể cực lạnh hoặc cực nóng trong ảnh nhiệt mà có thể làm biến dạng vật đó (ví dụ: bộ tản nhiệt dưới dạng vật thể nóng khi tìm kiếm cầu nhiệt).

Để chuyển thang đo sang tự động, hãy nhấn lại nút chức năng bên phải (7). Các nhiệt độ được xử lý động và được điều chỉnh phù hợp với các giá trị tối thiểu và tối đa.

Các chức năng đo

Để mở các chức năng khác, mà có thể hữu ích khi hiển thị, hãy nhấn nút **Func** (6). Hãy điều hướng đến các tùy chọn được hiển thị bằng các nút mũi tên bên trái (12) hoặc bên phải (8) để chọn một chức năng. Hãy chọn một chức năng và nhấn lại nút **Func** (6).

Các chức năng đo sau sẵn có cho bạn:

- **<Tự động>**
Sự phân bố màu trong ảnh nhiệt được thực hiện tự động.
- **<Dò nóng>**
Trong chức năng đo này chỉ các nhiệt độ cao trong vùng đo mới được hiển thị dưới dạng ảnh nhiệt. Vùng bên ngoài các nhiệt độ cao này được hiển thị dưới dạng ảnh thực trong hình ảnh thang độ xám. Hiển thị trong thang độ xám ngăn kết nối sai đối tượng màu với nhiệt độ (ví dụ cáp đo trong buồng chuyển mạch khi tìm kiếm các phần tử bị quá nhiệt). Hãy điều chỉnh thang đo bằng các nút lên (5) và xuống (10). Do đó khoảng nhiệt độ đã hiển thị được mở rộng hoặc thu nhỏ dưới dạng ảnh nhiệt. Dụng cụ đo sẽ tiếp tục đo các nhiệt độ tối thiểu và tối đa và hiển thị chúng ở đầu cuối của thang đo (h).

– <Dò lạnh>

Trong chức năng đo này chỉ các nhiệt độ thấp trong vùng đo mới được hiển thị dưới dạng ảnh nhiệt. Vùng bên ngoài các nhiệt độ thấp này được hiển thị dưới dạng ảnh thực trong hình ảnh thang độ xám, để không kết nối sai đối tượng màu với nhiệt độ (ví dụ khung cửa sổ màu xanh dương khi tìm kiếm hệ thống cách nhiệt lỗi). Hãy điều chỉnh thang đo bằng các nút lên (5) và xuống (10). Do đó khoảng nhiệt độ đã hiển thị được mở rộng hoặc thu nhỏ dưới dạng ảnh nhiệt. Dụng cụ đo sẽ tiếp tục đo các nhiệt độ tối thiểu và tối đa và hiển thị chúng ở đầu cuối của thang đo (h).

– <Thủ công>

Nếu các nhiệt độ chênh lệch mạnh trong ảnh nhiệt được đo (ví dụ thiết bị sưởi ấm dưới dạng đối tượng nóng khi kiểm tra cầu nhiệt), thì các màu sắc có sẽ được phân bố cho nhiều giá trị nhiệt độ trong khoảng giữa mức nhiệt độ tối đa và tối thiểu. Điều này có thể dẫn đến, các chênh lệch nhiệt độ tinh không được hiển thị chi tiết. Để hiển thị chi tiết khoảng nhiệt độ cần kiểm tra, hãy tiến hành như sau: Sau khi bạn chuyển sang chế độ <Thủ công>, bạn có thể điều chỉnh nhiệt độ tối đa hoặc tối thiểu. Bạn có thể ấn định khoảng nhiệt độ, mà quan trọng với bạn và bạn muốn nhận diện sự chênh lệch tinh. Thiết lập <Thiết lập lại thang đo> sẽ tự động điều chỉnh thang đo phù hợp với các giá trị đo được trong trường quan sát của cảm biến hồng ngoại.

Menu chính

Để đến menu chính, hãy nhấn phím **Func (6)** để mở các chức năng đo. Giờ hãy nhấn nút chức năng bên phải (7).

– <Đo>

▪ <Độ phát xạ> (d)

Đối với một vài nguyên vật liệu thông dụng nhất, có thể lựa chọn độ phát xạ đã lưu. Để giúp tìm kiếm dễ dàng hơn, các giá trị được nhóm lại trong danh mục độ phát xạ. Trong mục menu <Vật liệu>, trước tiên hãy chọn danh mục thích hợp và sau đó chọn nguyên liệu thích hợp. Độ phát xạ phù hợp sẽ được hiển thị trong dòng bên dưới. Nếu bạn biết mức phát xạ chính xác của đối tượng đo của mình, bạn cũng có thể đặt giá trị này làm giá trị số trong mục menu <Độ phát xạ>.

Nếu bạn thường xuyên đo các vật liệu giống nhau, bạn có thể lưu 5 độ phát xạ làm mục yêu thích và gọi chúng ra nhanh chóng bằng cách sử dụng thanh trên cùng (được đánh số từ 1 đến 5).

▪ <Nhiệt độ phản xạ> (c)

Đặt thông số này có thể cải thiện kết quả đo, đặc biệt đối với các vật liệu có độ phát xạ thấp (= phản xạ cao). Trong một số trường hợp (đặc biệt là trong nhà), nhiệt độ phản xạ tương

ứng với nhiệt độ môi trường. Nếu các vật thể có nhiệt độ chênh lệch nhiều gần các vật thể phản xạ cao có thể ảnh hưởng đến phép đo, bạn nên điều chỉnh giá trị này.

– <Hiển thị>

▪ <Trọng tâm> (l)

Điểm được hiển thị ở giữa ảnh nhiệt và cho bạn biết giá trị nhiệt độ đã đo ở vị trí này.

▪ <Điểm nóng> (k): <bật>/<tắt>

Điểm nóng nhất (= Pixel đo) được đánh dấu bằng một đường chữ thập đỏ trong ảnh nhiệt. Điều này giúp dễ dàng tìm kiếm các điểm quan trọng (ví dụ: đầu cuối tiếp xúc lỏng trong tủ chuyển mạch). Để có phép đo chính xác nhất có thể, hãy tập trung đối tượng đo vào chính giữa màn hình (85 x 64 px). Bằng cách này, giá trị nhiệt độ tương ứng của đối tượng đo này cũng được hiển thị.

▪ <Điểm lạnh> (m): <bật>/<tắt>

Điểm lạnh nhất (= Pixel đo) được đánh dấu bằng đường chữ thập màu xanh dương trong ảnh nhiệt. Điều này giúp dễ dàng tìm kiếm các điểm quan trọng (ví dụ điểm không kín trong cửa sổ). Để có phép đo chính xác nhất có thể, hãy tập trung đối tượng đo vào chính giữa màn hình (85 x 64 px).

▪ <Thang màu> (h): <bật>/<tắt>

▪ <Nhiệt độ trung bình> (b): <bật>/<tắt>

Nhiệt độ trung bình (b) được hiển thị phía trên bên trái trong ảnh nhiệt (nhiệt độ trung bình của tất cả giá trị được đo trong ảnh nhiệt). Điều này có thể cho phép bạn xác định nhiệt độ phản xạ dễ dàng hơn.

– <Wi-Fi> (e): <bật>/<tắt>

(xem „Truyền dữ liệu“, Trang 73)

– <Thiết bị>

▪ <Ngôn ngữ>

Tại mục menu này bạn có thể chọn ngôn ngữ đã dùng trong hiển thị.

▪ <Ngày & Giờ> (a)

Để thay đổi ngày và giờ trong dụng cụ đo, hãy vào menu con <Ngày & Giờ>. Trong menu con này, ngoài cài đặt ngày và giờ, bạn cũng có thể thay đổi định dạng tương ứng của chúng. Để thoát menu con <Thời gian> và <Ngày> hãy nhấn phím chức năng bên phải (7) để lưu cài đặt hoặc phím chức năng bên trái (14) để hủy các thay đổi.

▪ <Thời gian tắt>

Dưới mục menu này bạn có thể chọn khoảng thời gian để lưu sau khoảng thời gian đó, máy đo cần tự động ngắt nếu không có phím nào được bấm. Bạn cũng có thể tắt tính năng tự động tắt bằng cách chọn cài đặt <Không bao giờ>.

▪ <Kênh Wifi>

Tại mục menu này bạn có thể thiết lập một kênh Wi-Fi® khác.

- **<Chất lượng âm thanh cao>**
Tại mục menu này, bạn có thể điều chỉnh chất lượng của tập tin âm thanh đã ghi qua ghi chú bằng giọng nói. Khi đó hãy lưu ý rằng chất lượng âm thanh cao cần nhiều vị trí lưu hơn.
- **<Thông tin thiết bị>**
Tại mục menu này bạn có thể phục hồi các thông tin qua dụng cụ đo. Ở đó, bạn sẽ tìm thấy số seri của máy đo và phiên bản phần mềm được cài đặt.
- **<Khôi phục cài đặt gốc>**
Tại mục menu này, bạn có thể đặt lại dụng cụ đo về cài đặt gốc và xóa vĩnh viễn tất cả dữ liệu. Quá trình này có thể mất vài phút. Nhấn phím mũi tên phải (8) cho <Thêm>, để vào menu phụ. Sau đó nhấn phím chức năng bên phải (7), để xóa tất cả các tệp hoặc phím chức năng bên trái (14), để hủy.

Để rời Menu ngẫu nhiên và quay trở lại màn hình hiển thị chuẩn, bạn cũng có thể nhấn nút đo (20).

Tài liệu về kết quả đo

Lưu kết quả đo

Ngay sau khi bật, dụng cụ đo sẽ bắt đầu bằng việc đo và sẽ tiếp tục cho đến khi bị tắt.

Để lưu ảnh, hãy hướng camera vào đối tượng đo mong muốn và nhấn nút lưu (11). Ảnh được lưu trong bộ nhớ trong của dụng cụ đo. Ngoài ra hãy nhấn nút đo (20) (Tạm dừng). Phép đo được đóng băng và được hiển thị trong màn hình hiển thị. Điều này cho phép bạn quan sát kỹ các ảnh và điều chỉnh sau đó (ví dụ băng màu). Nếu bạn không muốn lưu ảnh đã đóng băng, hãy khởi động lại chế độ đo bằng nút đo (20). Nếu bạn muốn lưu ảnh trong bộ nhớ của dụng cụ đo, hãy nhấn nút lưu (11).

Ghi lại ghi chú bằng giọng nói

Bạn có thể ghi lại ghi chú bằng giọng nói để giữ lại các điều kiện môi trường xung quanh hoặc các thông tin bổ sung cho ảnh nhiệt đã lưu. Nó được lưu bổ sung cho ảnh nhiệt và ảnh trực quan và có thể được truyền đi sau.

Nên ghi lại ghi chú bằng giọng nói để đảm bảo ghi tài liệu tốt hơn.

Việc ghi lại ghi chú bằng giọng nói được thực hiện trong thư viện. Tiến hành như sau:

- Hãy nhấn phím chức năng bên trái (14) để vào menu.
- Hãy nhấn phím **Func (6)**. Ghi bắt đầu. Hãy ghi tất cả thông tin liên quan.
- Để **kết thúc** ghi, hãy nhấn lại nút **Func (6)** hoặc nút chức năng bên phải (7).
- Để **hủy** ghi, hãy nhấn nút chức năng bên trái (14). Sau khi ghi, bạn có thể nghe ghi chú bằng giọng nói.
- Để **nghe** bản ghi, hãy nhấn lại nút **Func (6)**. Bản ghi được phát.

- Để **tạm dừng** phát, hãy nhấn nút chức năng bên phải (7). Để phát tiếp bản ghi đã tạm dừng, hãy nhấn lại nút chức năng bên phải (7).
- Để **dừng** phát, hãy nhấn nút chức năng bên trái (14).

Để ghi một ghi chú bằng giọng nói mới, hãy xóa ghi chú bằng giọng nói hiện có và sau đó bắt đầu ghi âm mới.

Khi ghi hãy chú ý:

- Micro (13) ở phía sau bàn phím cạnh biểu tượng micro. Hãy nói theo hướng micro.
- Bản ghi có thể dài tối đa 30 s.

Mở các ảnh đã lưu

Để mở các ảnh nhiệt đã lưu hãy thực hiện như sau:

- Hãy nhấn nút chức năng bên trái (14). Trên màn hình bây giờ sẽ xuất hiện ảnh đã được lưu gần nhất.
- Nhấn phím mũi tên phải (8) hoặc trái (12), để đổi các ảnh nhiệt đã lưu.

Ngoài ảnh nhiệt, ảnh trực quan cũng được lưu. Để mở ảnh này, hãy nhấn nút mũi tên xuống (10).

Bạn có thể hiển thị ảnh nhiệt đã ghi cũng như hiển thị toàn màn hình bằng cách nhấn nút mũi tên lên (5). Trong chế độ hiển thị toàn màn hình, hiển thị thanh tiêu đề bị ẩn sau 3 s để bạn có thể xem tất cả chi tiết của ảnh nhiệt.

Bạn có thể chuyển đổi các chế độ xem bằng nút mũi tên lên (5) và xuống (10).

Xóa các ảnh và ghi chú bằng giọng nói đã lưu

Để xóa từng hoặc tất cả ảnh nhiệt hãy chuyển đến kiểu nhìn bộ sưu tập:

- Hãy nhấn nút chức năng phải (7) dưới biểu tượng Thùng rác. Một menu con mở ra. Tại đây, bạn có thể chọn xem bạn chỉ muốn xóa ảnh này, ghi chú bằng giọng nói liên quan (nếu bạn đã ghi) hãy muốn xóa tất cả ảnh. Nếu bạn chỉ muốn xóa ảnh này hoặc ghi chú bằng giọng nói, bạn hãy kích hoạt quá trình bằng nút **Func (6)**.
- Nếu bạn muốn xóa tất cả ảnh, hãy nhấn nút **Func (6)** hoặc nút chức năng bên phải (7), kích hoạt quá trình bằng các nút chức năng bên phải (7) hoặc hủy quá trình xóa bằng cách nhấn nút chức năng bên trái (14).

Các đoạn dữ liệu của hình ảnh vẫn còn trong bộ nhớ và có thể được tái tạo lại. Để xóa vĩnh viễn, hãy chọn trong menu chính <Thiết bị> → <Khôi phục cài đặt gốc>.

Truyền dữ liệu

Truyền dữ liệu qua giao diện USB

Mở nắp ổ cắm USB Type-C® (3). Kết nối ổ cắm USB Type-C® (4) của dụng cụ đo với máy tính bằng cáp USB Type-C® (23).

Bây giờ bật dụng cụ đo bằng nút bật/tắt (9).

Mở trình duyệt tệp trên máy tính của bạn và chọn ổ đĩa **GTC 600 C**. Các tệp đã lưu có thể được sao chép từ bộ nhớ trong của dụng cụ đo, chuyển sang máy tính của bạn hoặc xóa.

Ngay sau khi bạn kết thúc quá trình mong muốn, hãy ngắt kết nối ổ đĩa khỏi máy tính theo mặc định rồi tắt dụng cụ đo một lần nữa bằng nút bật / tắt (9).

Chú ý: Luôn thoát khỏi ổ đĩa từ hệ điều hành của bạn (thoát ổ đĩa), nếu không bộ nhớ trong của dụng cụ đo có thể bị hỏng.

Tháo cáp USB Type-C® **trong khi** khi vận hành đo và đóng nắp dây (3).

Luôn đóng kín nắp che của giao diện USB, để không có bụi hoặc nước phun xâm nhập vào vỏ bọc.

Lưu ý: Chỉ kết nối dụng cụ đo với máy tính qua USB. Dụng cụ đo có thể bị hỏng khi kết nối với các thiết bị khác.

Hướng dẫn: Giao diện USB Type-C® chỉ dùng để truyền dữ liệu. Pin và ắc quy có thể không được sạc qua đó.

Xử lý tiếp ảnh nhiệt

Bạn có thể xử lý tiếp các ảnh nhiệt đã lưu trên máy tính có hệ điều hành Windows. Hãy tải xuống phần mềm GTC Transfer từ trang sản phẩm của dụng cụ đo tại www.bosch-professional.com.

Truyền dữ liệu qua WLAN

Dụng cụ đo được trang bị giao diện Wi-Fi® cho phép truyền hình ảnh đã lưu không dây từ dụng cụ đo đến thiết bị di động.

Các ứng dụng (Apps) đặc biệt của Bosch được cung cấp để sử dụng. Tùy theo thiết bị đầu cuối, bạn có thể tải những ứng dụng này trong các kho lưu trữ thích hợp:









Các ứng dụng của Bosch cho phép bạn (ngoài việc truyền dữ liệu hình ảnh không dây) một loạt các chức năng và đơn giản hóa việc xử lý sau và chuyển tiếp dữ liệu đo lường (ví dụ: qua email). Các thông tin về điều kiện hệ thống cần thiết cho việc kết nối Wi-Fi® có thể tìm thấy trên trang Web của Bosch theo địa chỉ www.bosch-professional.com.



Để kích hoạt/vô hiệu hóa kết nối Wi-Fi® tại dụng cụ đo, hãy mở menu chính, điều hướng bằng nút chọn <WiFi> và kích hoạt/vô hiệu hóa nó. Khi kích hoạt Wi-Fi®, hiển thị (e) sẽ xuất hiện trên màn hình. Hãy chắc chắn rằng, giao diện Wi-Fi® trên thiết bị di động đầu cuối của bạn đã được kích hoạt.

Sau khi khởi động ứng dụng Bosch (ở mô-đun Wi-Fi® đã kích hoạt), kết nối giữa thiết bị đầu cuối và máy đo có thể được thiết lập. Do đó hãy tuân theo các hướng dẫn của ứng dụng (App).

Lỗi – Nguyên nhân và biện pháp khắc phục

Nếu có trục trặc dụng cụ đo sẽ tiến hành khởi động lại và có thể được sử dụng lại trong kết nối. Ngoài ra, tổng quan dưới đây có thể giúp bạn khi có thông báo lỗi liên tục.

Lỗi	Nguyên nhân	Biện pháp khắc phục
 Không thể bật dụng cụ đo.	Bộ nguồn cạn điện	Hãy sạc pin.
 Pin quá nóng hoặc quá lạnh	Pin quá nóng hoặc quá lạnh	Để pin nguội hoặc thay pin.
 Dụng cụ đo quá nóng hoặc quá lạnh	Dụng cụ đo quá nóng hoặc quá lạnh	Hãy để dụng cụ đo nguội bớt.
 Bộ nhớ hình ảnh đầy	Bộ nhớ hình ảnh đầy	Nếu cần, hãy chuyển hình ảnh sang phương tiện lưu trữ khác (ví dụ: máy tính). Sau đó xóa ảnh trong bộ nhớ trong.
 Bộ nhớ hình ảnh bị lỗi	Bộ nhớ hình ảnh bị lỗi	Định dạng bộ nhớ trong bằng cách xóa tất cả ảnh. Nếu sự cố vẫn tiếp diễn, hãy gửi dụng cụ đo đến trung tâm dịch vụ khách hàng được ủy quyền của Bosch.
 truyền dữ liệu chậm với kết nối Wi-Fi®	truyền dữ liệu chậm với kết nối Wi-Fi®	Thay đổi kênh Wi-Fi® (trong menu chính dưới <Thiết bị> → <Kênh Wifi>).
 Máy tính không nhận biết được dụng cụ đo.	Máy tính không nhận biết được dụng cụ đo.	Đảm bảo rằng trình điều khiển trên máy tính của bạn được cập nhật. Có thể cần phiên bản hệ điều hành mới hơn trên máy tính.

Lỗi	Nguyên nhân	Biện pháp khắc phục
Không thể kết nối dụng cụ đo với máy tính.	Cổng kết nối USB-hoặc cáp USB hỏng	Kiểm tra xem dụng cụ đo có thể được kết nối với máy tính khác không. Nếu không, hãy gửi dụng cụ đo đến trung tâm dịch vụ khách hàng được ủy quyền của Bosch.
	Pin cục áo trống cạn	Hãy yêu cầu Bosch hoặc trung tâm dịch vụ khách hàng được ủy quyền thay thế pin cục áo cho dụng cụ điện Bosch.
	Dụng cụ đo bị lỗi	Hãy gửi dụng cụ đo đến trung tâm dịch vụ khách hàng được ủy quyền của Bosch.

Giải thích khái niệm

Hãy xem thêm thông tin chi tiết trên trang www.bosch-professional.com.

Bức xạ nhiệt hồng ngoại

Bức xạ nhiệt hồng ngoại là bức xạ điện từ do môi cơ thể phát ra trên 0 Kelvin (-273 °C). Lượng bức xạ phụ thuộc vào nhiệt độ và độ phát xạ của cơ thể.

Độ phát xạ

Độ phát xạ của một vật phụ thuộc vào nguyên vật liệu và cấu trúc bề mặt của vật đó. Nó cho biết vật thể phát ra bao nhiêu bức xạ nhiệt hồng ngoại so với một bộ tản nhiệt lý tưởng (vật đen, độ phát xạ $\epsilon = 1$) và theo đó là giá trị từ 0 đến 1.

Cấu nhiệt

Cấu nhiệt là một điểm trên tường ngoài của một tòa nhà nơi kết cấu gây ra sự mất nhiệt tăng cục bộ. Cấu nhiệt có thể dẫn đến tăng nguy cơ nấm mốc.

Nhiệt độ được phản xạ/tính phản xạ của đối tượng

Nhiệt độ được phản xạ là những bức xạ nhiệt, không tự phát ra từ đối tượng. Tùy thuộc vào cấu trúc và vật liệu, bức xạ xung quanh được phản xạ trong đối tượng cần đo và do đó làm sai lệch kết quả nhiệt độ thực tế.

Khoảng cách của đối tượng

Khoảng cách giữa đối tượng đo và dụng cụ đo ảnh hưởng đến kích thước bề mặt thu được mỗi Pixel. Với khoảng cách lớn của đối tượng, bạn có nhận diện đối tượng lớn hơn.

Khoảng cách (m)	Kích thước Infrarot Pixel (mm)	Vùng hồng ngoại Chiều rộng x Chiều cao (m)
0,3	1	0,25 x 0,19
0,55	2	~ 0,46 x 0,35
1	3	~ 0,83 x 0,63
2	6	~ 1,66 x 1,26
5	16	~ 4,14 x 3,15

Bảo Dưỡng và Bảo Quản

Bảo Dưỡng Và Làm Sạch

Chỉ cất và vận chuyển máy đo trong hộp phù hợp như bao bì ban đầu.

Luôn luôn giữ cho dụng cụ đo thật sạch sẽ. Cảm biến hồng ngoại bị bẩn (21) có thể làm giảm độ chính xác của phép đo.

Tuyệt đối không để nước rò vào máy trong quá trình làm sạch.

Không thử dùng vật nhọn để lấy chất bẩn khỏi cảm biến hồng ngoại (21), Camera (22), loa (16) hoặc micro (13). Không vượt trên cảm biến hồng ngoại và camera (Nguy cơ xước).

Nếu bạn muốn hiệu chuẩn lại dụng cụ đo của mình, vui lòng liên hệ với trung tâm dịch vụ khách hàng được ủy quyền của Bosch.

Trong trường hợp cần sửa chữa, hãy gửi dụng cụ đo trong bao bì ban đầu.

Trong dụng cụ đo không có bộ phận có thể bảo dưỡng bởi người dùng. Mở vỏ máy có thể làm hỏng thiết bị đo.

Thay thế pin cục áo tích hợp

Pin cục áo phải được thay thế bởi Bosch hoặc trung tâm dịch vụ khách hàng được ủy quyền dành cho dụng cụ điện Bosch.

- ▶ **Lưu ý: Luôn thay thế pin nút áo bằng pin nút áo cùng loại.** Sự nguy hiểm của nổ.
- ▶ **Tháo và xử lý các pin nút áo đã tháo xả đúng cách.** Các pin nút áo đã tháo xả có thể rò rỉ và do đó gây hư hỏng sản phẩm hoặc gây thương tích cho người.

Dịch vụ hỗ trợ khách hàng và tư vấn sử dụng

Bộ phận phục vụ hàng sau khi bán của chúng tôi trả lời các câu hỏi liên quan đến việc bảo dưỡng và sửa chữa các sản phẩm cũng như phụ tùng thay thế của bạn. Sơ đồ mô tả và thông tin về phụ tùng thay thế cũng có thể tra cứu theo dưới đây:

www.bosch-pt.com

Đội ngũ tư vấn sử dụng của Bosch sẽ giúp bạn giải đáp các thắc mắc về sản phẩm và phụ kiện.

Trong tất cả các phản hồi và đơn đặt phụ tùng, xin vui lòng luôn luôn nhập số hàng hóa 10 chữ số theo nhãn của hàng hóa.

Việt Nam

CN CÔNG TY TNHH BOSCH VIỆT NAM TẠI
TP.HCM
Tầng 14, Ngôi Nhà Đức, 33 Lê Duẩn
Phường Bến Nghé, Quận 1, Thành Phố Hồ Chí Minh
Tel.: (028) 6258 3690
Fax: (028) 6258 3692 - 6258 3694
Hotline: (028) 6250 8555
Email: tuvankhachhang-pt@vn.bosch.com
www.bosch-pt.com.vn
www.baohanhbosch-pt.com.vn

Xem thêm địa chỉ dịch vụ tại:

www.bosch-pt.com/serviceaddresses

Vận chuyển

Pin Li-Ion được khuyến nghị là đối tượng phải tuân theo các qui định của Pháp Luật về Hàng Hóa Nguy Hiểm. Người sử dụng có thể vận chuyển pin hợp khối bằng đường bộ mà không cần thêm yêu cầu nào khác.

Khi được vận chuyển thông qua bên thứ ba (vd. vận chuyển bằng đường hàng không hay đại lý giao nhận), phải tuân theo các yêu cầu đặc biệt về đóng gói và dán nhãn. Phải tham vấn chuyên gia về hàng hóa nguy hiểm khi chuẩn bị gói hàng.

Chỉ gửi pin hợp khối khi vỏ ngoài không bị hư hỏng. Dán băng keo hay che kín các điểm tiếp xúc hở và đóng gói pin hợp khối theo cách sao cho pin không thể xê dịch khi nằm trong bao bì. Ngoài ra, xin vui lòng chấp hành các qui định chi tiết có thể được bổ sung thêm của quốc gia.

Sự thải bỏ



Máy đo, ắc quy/pin, phụ kiện và bao bì cần được tái sử dụng theo quy định về môi trường.



Không vứt dụng cụ đo và pin/ắc quy cùng trong rác thải của gia đình!

Pin:

Li-Ion:

Tuân thủ những hướng dẫn trong phần vận chuyển (xem „Vận chuyển“, Trang 76).